

Model Name: food_processor

Weight: 498.72 g

Built to last: 1.0 year

Duration of use: 1.0 year



Manufacturing Region

The choice of manufacturing region determines the energy sources and technologies used in the modeled material creation and manufacturing steps of the product's life cycle.

Use Region

The use region is used to determine the energy sources consumed during the product's use phase (if applicable) and the destination for the product at its end-of-life. Together with the manufacturing region, the use region is also used to estimate the environmental impacts associated with transporting the product from its manufacturing location to its use location.

Summary

Sustainability Report

Model Name: food_processor

Weight: 498.72 g

Built to last: 1.0 year

Duration of use: 1.0 year

Assembly Process

Region: Asia
Energy type: None
Energy amount: 0.00 kWh
Built to last: 1.0 year

Use

Region: North America
Energy type: Electricity
Energy amount: 2.00 kWh
Duration of use: 1.0 year

Transportation

Truck distance: 0.00 km
Train distance: 0.00 km
Ship distance: 1.2E+4 km
Airplane Distance: 0.00 km

End of Life

Recycled: 33 %
Incinerated: 13 %
Landfill: 54 %

Comments

[Click here for alternative units such as 'Miles Driven in a Car'](#)

Model Name: food_processor

Weight: 498.72 g

Built to last: 1.0 year

Duration of use: 1.0 year

Environmental Impact (calculated using CML impact assessment methodology)

Carbon Footprint



5.0 kg CO₂e

Material:	2.6 kg CO ₂ e
Manufacturing:	0.413 kg CO ₂ e
Use:	1.6 kg CO ₂ e
Transportation:	0.032 kg CO ₂ e
End of Life:	0.274 kg CO ₂ e

Total Energy Consumed



65 MJ

Material:	35 MJ
Manufacturing:	6.0 MJ
Use:	23 MJ
Transportation:	0.400 MJ
End of Life:	0.201 MJ

Air Acidification



0.032 kg SO₂e

Material:	0.018 kg SO ₂ e
Manufacturing:	2.8E-3 kg SO ₂ e
Use:	0.011 kg SO ₂ e
Transportation:	1.0E-3 kg SO ₂ e
End of Life:	1.4E-4 kg SO ₂ e

Water Eutrophication



6.3E-3 kg PO₄e

Material:	5.4E-3 kg PO ₄ e
Manufacturing:	1.0E-4 kg PO ₄ e
Use:	4.0E-4 kg PO ₄ e
Transportation:	9.6E-5 kg PO ₄ e
End of Life:	3.4E-4 kg PO ₄ e

Material Financial Impact

1.40 USD

Comments

[Click here for alternative units such as 'Miles Driven in a Car'](#)

Sustainability Report

Model Name: food_processor























Weight: 498.72 g

Built to last: 1.0 year

Duration of use: 1.0 year

Component Environmental Impact

Top Ten Components Contributing Most to the Four Areas of Environmental Impact

Component	Carbon	Water	Air	Energy
gear- caddy	1.2 	6.2E-4 	0.013 	14 
shaft gear	0.802 	2.7E-3 	3.5E-3 	8.9 
middle-gear	0.580 	2.0E-3 	2.5E-3 	6.4 
base plate	0.646 	3.0E-4 	1.9E-3 	12 
drive shaft	0.055 	1.9E-4 	2.4E-4 	0.611 
drive shaft plate	0.028 	6.2E-6 	1.9E-4 	0.345 
middle-gear plate	0.017 	6.1E-6 	6.8E-5 	0.218 
shaft washer	2.6E-3 	9.0E-6 	1.1E-5 	0.029 
rubber feet	3.3E-3 	1.5E-6 	7.8E-6 	0.061 
drive shaft pin	8.4E-4 	2.9E-6 	3.6E-6 	9.3E-3 

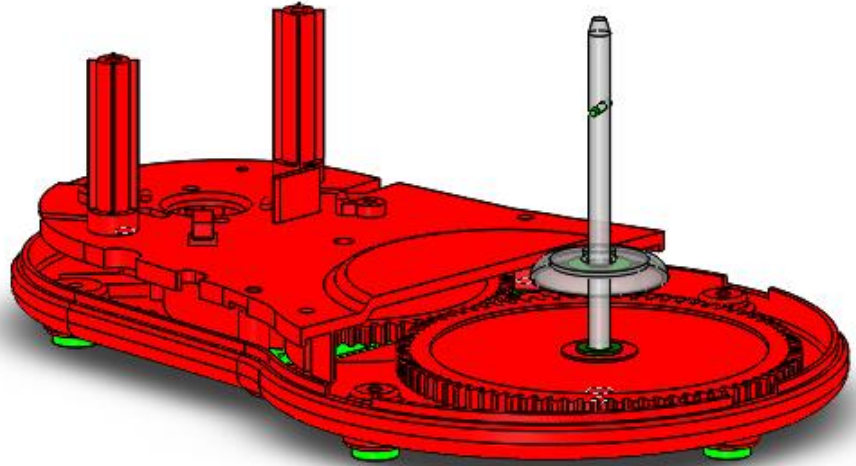

Comments

[Click here for alternative units such as 'Miles Driven in a Car'](#)



Glossary

Air Acidification - Sulfur dioxide, nitrous oxides other acidic emissions to air cause an increase in the acidity of rainwater, which in turn acidifies lakes and soil. These acids can make the land and water toxic for plants and aquatic life. Acid rain can also slowly dissolve manmade building materials such as concrete. This impact is typically measured in units of either kg **sulfur dioxide equivalent (SO₂)**, or **moles H⁺ equivalent**.

Carbon Footprint - Carbon-dioxide and other gasses which result from the burning of fossil fuels accumulate in the atmosphere which in turn increases the earth's average temperature. Carbon footprint acts as a proxy for the larger impact factor referred to as Global Warming Potential (GWP). Global warming is blamed for problems like loss of glaciers, extinction of species, and more extreme weather, among others.

Total Energy Consumed - A measure of the non-renewable energy sources associated with the part's lifecycle in units of megajoules (**MJ**). This impact includes not only the electricity or fuels used during the product's lifecycle, but also the upstream energy required to obtain and process these fuels, and the embodied energy of materials which would be released if burned. PED is expressed as the net calorific value of energy demand from non-renewable resources (e.g. petroleum, natural gas, etc.). Efficiencies in energy conversion (e.g. power, heat, steam, etc.) are taken into account.

Water Eutrophication - When an over abundance of nutrients are added to a water ecosystem, eutrophication occurs. Nitrogen and phosphorous from waste water and agricultural fertilizers causes an overabundance of algae to bloom, which then depletes the water of oxygen and results in the death of both plant and animal life. This impact is typically measured in either kg **phosphate equivalent (PO₄)** or **kg nitrogen (N) equivalent**.

Life Cycle Assessment (LCA) - This is a method to quantitatively assess the environmental impact of a product throughout its entire lifecycle, from the procurement of the raw materials, through the production, distribution, use, disposal and recycling of that product.

Material Financial Impact - This is the financial impact associated with the material only. The mass of the model is multiplied by the financial impact unit (units of currency/units of mass) to calculate the financial impact (in units of currency).

[Learn more about Life Cycle Assessment](#) 