

Precalculus

Second Edition (2.7)

Thomas Tradler
Holly Carley

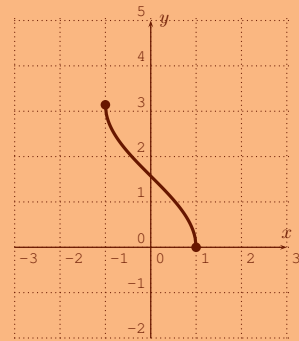
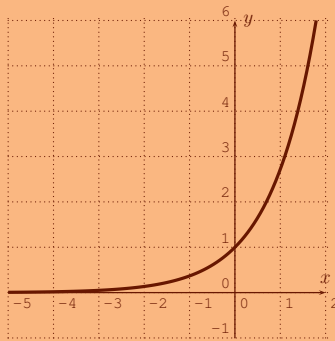
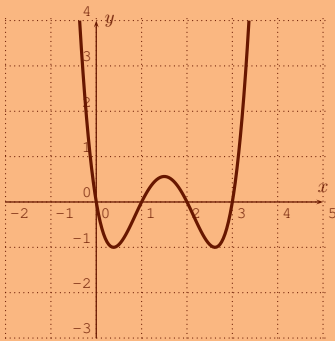

Copyright ©2012 Thomas Tradler and Holly Carley

This work is licensed under a Creative Commons Attribution-NonCommercial-ShareAlike 4.0 International License. (CC BY-NC-SA 4.0)

To view a copy of the license, visit:

<http://creativecommons.org/licenses/by-nc-sa/4.0/>

Under this license, you are free to:

- **Share:** copy and redistribute the material in any medium or format
- **Adapt:** remix, transform, and build upon the material

The licensor cannot revoke these freedoms as long as you follow the license terms.

Under the following terms:

- **Attribution:** You must give appropriate credit, provide a link to the license, and indicate if changes were made. You may do so in any reasonable manner, but not in any way that suggests the licensor endorses you or your use.
- **NonCommercial:** You may not use the material for commercial purposes.
- **ShareAlike:** If you remix, transform, or build upon the material, you must distribute your contributions under the same license as the original.

No additional restrictions: You may not apply legal terms or technological measures that legally restrict others from doing anything the license permits.

Notices:

- You do not have to comply with the license for elements of the material in the public domain or where your use is permitted by an applicable exception or limitation.
- No warranties are given. The license may not give you all of the permissions necessary for your intended use. For example, other rights such as publicity, privacy, or moral rights may limit how you use the material.

This document was created with \LaTeX . The TI-84 images were created with the TI-SmartView software.

Preface

These are notes for a course in precalculus, as it is taught at New York City College of Technology - CUNY (where it is offered under the course number MAT 1375). Our approach is calculator based. For this, we will use the currently standard TI-84 calculator, and in particular, many of the examples will be explained and solved with it. However, we want to point out that there are also many other calculators that are suitable for the purpose of this course and many of these alternatives have similar functionalities as the calculator that we have chosen to use. An introduction to the TI-84 calculator together with the most common applications needed for this course is provided in appendix A. In the future we may expand on this by providing introductions to other calculators or computer algebra systems.

This course in precalculus has the overarching theme of “functions.” This means that many of the often more algebraic topics studied in the previous courses are revisited under this new function theoretic point of view. However, in order to keep this text as self contained as possible we always recall all results that are necessary to follow the core of the course even if we assume that the student has familiarity with the formula or topic at hand. After a first introduction to the abstract notion of a function, we study polynomials, rational functions, exponential functions, logarithmic functions, and trigonometric functions with the function viewpoint. Throughout, we will always place particular importance to the corresponding graph of the discussed function which will be analyzed with the help of the TI-84 calculator as mentioned above. These are in fact the topics of the first four (of the five) parts of this precalculus course.

In the fifth and last part of the book, we deviate from the above theme and collect more algebraically oriented topics that will be needed in calculus or other advanced mathematics courses or even other science courses. This part includes a discussion of the algebra of complex numbers (in particular complex numbers in polar form), the 2-dimensional real vector space \mathbb{R}^2 , se-

quences and series with focus on the arithmetic and geometric series (which are again examples of functions, though this is not emphasized), and finally the generalized binomial theorem.

In short, here is an outline of the topics in this course and the five parts into which this course is divided:

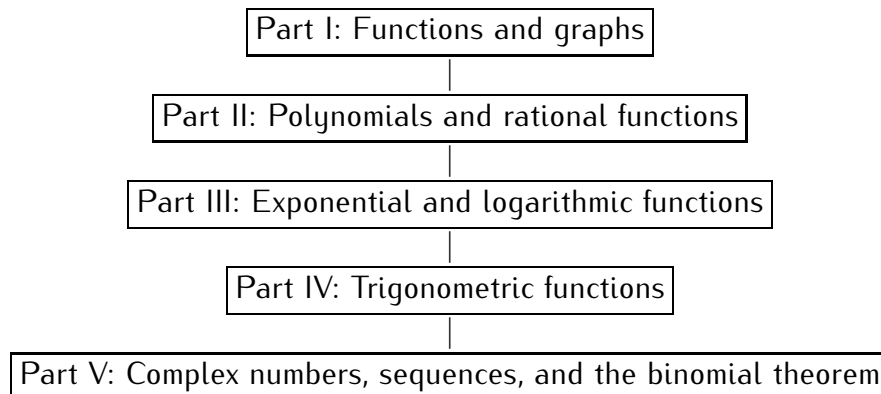

The topics in this book are organized in 25 sessions, each session corresponding to one class meeting. Each session ends with a list of exercises that the student is expected to be able to solve. We cannot overstate the importance of completing these exercises for a successful completion of this course. These 25 sessions, together with 4 scheduled exams and one review session give a total of 30 class sessions, which is the number of regularly scheduled class meetings in one semester. Each of the five parts also ends with a review of the topics discussed. This may be used as a review for any of the exams during the semester. Finally, we point out that there is an overview of the important formulas used in this course at the end of the book.

We would like to thank our colleagues and students for their support during the development of this project. In particular, we would like to thank Henry Africk, Johanna Ellner, Lin Zhou, Satyanand Singh, Jean Camilien, Leo Chosid, Laurie Caban, Natan Ovshey, Johann Thiel, Wendy Wang, Steven Karaszewski, Josue Enriquez, and Mohd Nayum Parvez, Akindiji Fadeyi, Isabel Martinez, Erik Nowak, Sybil Shaver, Faran Hoosain, Kenia Rodriguez, Albert Jaradeh, Iftekher Hossain for many useful comments that helped to improve this text.

Thomas Tradler and Holly Carley
New York City College of Technology - CUNY
September 2015

Contents

Preface	iii
Table of contents	v
I Functions and graphs	1
1 The absolute value	2
1.1 Background regarding numbers	2
1.2 The absolute value	3
1.3 Inequalities and intervals	4
1.4 Absolute value inequalities	6
1.5 Exercises	11
2 Lines and functions	13
2.1 Lines, slope and intercepts	13
2.2 Introduction to functions	22
2.3 Exercises	28
3 Functions by formulas and graphs	32
3.1 Functions given by formulas	32
3.2 Functions given by graphs	37
3.3 Exercises	44
4 Introduction to the TI-84	49
4.1 Graphing with the TI-84	49
4.2 Finding zeros, maxima, and minima	53
4.3 Exercises	61

5	Basic functions and transformations	63
5.1	Graphing basic functions	63
5.2	Transformation of graphs	65
5.3	Exercises	73
6	Operations on functions	76
6.1	Operations on functions given by formulas	76
6.2	Operations on functions given by tables	81
6.3	Exercises	83
7	The inverse of a function	86
7.1	One-to-one functions	86
7.2	Inverse function	88
7.3	Exercises	95
	Review of functions and graphs	98
II	Polynomials and rational functions	100
8	Dividing polynomials	101
8.1	Long division	102
8.2	Dividing by $(x - c)$	106
8.3	<i>Optional section:</i> Synthetic division	109
8.4	Exercises	111
9	Graphing polynomials	113
9.1	Graphs of polynomials	113
9.2	Finding roots of a polynomial with the TI-84	121
9.3	<i>Optional section:</i> Graphing polynomials by hand	124
9.4	Exercises	127
10	Roots of polynomials	130
10.1	<i>Optional section:</i> The rational root theorem	130
10.2	The fundamental theorem of algebra	134
10.3	Exercises	144

CONTENTS	vii
11 Rational functions	147
11.1 Graphs of rational functions	147
11.2 <i>Optional section:</i> Rational functions by hand	159
11.3 Exercises	168
12 Polynomial and rational inequalities	169
12.1 Polynomial inequalities	169
12.2 Rational inequalities and absolute value inequalities	176
12.3 Exercises	179
Review of polynomials and rational functions	181
III Exponential and logarithmic functions	183
13 Exponential and logarithmic functions	184
13.1 Exponential functions and their graphs	184
13.2 Logarithmic functions and their graphs	190
13.3 Exercises	197
14 Properties of \exp and \log	199
14.1 Algebraic properties of \exp and \log	199
14.2 Solving exponential and logarithmic equations	202
14.3 Exercises	206
15 Applications of \exp and \log	208
15.1 Applications of exponential functions	208
15.2 Exercises	214
16 Half-life and compound interest	216
16.1 Half-life	216
16.2 Compound interest	220
16.3 Exercises	226
Review of exponential and logarithmic functions	229

IV	Trigonometric functions	231
17	Trigonometric functions	232
17.1	Basic trigonometric definitions and facts	232
17.2	\sin , \cos , and \tan as functions	239
17.3	Exercises	249
18	Addition of angles and multiple angles	252
18.1	Addition and subtraction of angles	252
18.2	Double and half angles	256
18.3	Exercises	261
19	Inverse trigonometric functions	262
19.1	The functions \sin^{-1} , \cos^{-1} , and \tan^{-1}	262
19.2	Exercises	269
20	Trigonometric equations	270
20.1	Basic trigonometric equations	270
20.2	Equations involving trigonometric functions	278
20.3	Exercises	283
	Review of trigonometric functions	284
V	Complex numbers, sequences, and the binomial theorem	286
21	Complex numbers	287
21.1	Polar form of complex numbers	287
21.2	Multiplication and division of complex numbers	294
21.3	Exercises	297
22	Vectors in the plane	299
22.1	Introduction to vectors	299
22.2	Operations on vectors	303
22.3	Exercises	309

23 Sequences and series	311
23.1 Introduction to sequences and series	311
23.2 The arithmetic sequence	318
23.3 Exercises	323
24 The geometric series	325
24.1 Finite geometric series	325
24.2 Infinite geometric series	330
24.3 Exercises	334
25 The binomial theorem	337
25.1 The binomial theorem	337
25.2 Binomial expansion	342
25.3 Exercises	345
Review of complex numbers, sequences, and the binomial theorem	347
A Introduction to the TI-84	349
A.1 Basic calculator functions	349
A.2 Graphing a function	353
A.2.1 Rescaling the graphing window	354
A.3 Graphing more than one function	357
A.4 Graphing a piecewise defined function	359
A.5 Using the table	361
A.6 Solving an equation using the solver	362
A.7 Special functions (absolute value, n -th root, etc.)	363
A.8 Programming the calculator	366
A.9 Common errors	370
A.10 Resetting the calculator to factory settings	373
Answers to exercises	374
Session 1	374
Session 2	375
Session 3	375
Session 4	377
Session 5	379
Session 6	380
Session 7	381

Review part I	383
Session 8	383
Session 9	384
Session 10	385
Session 11	386
Session 12	388
Review part II	389
Session 13	389
Session 14	392
Session 15	393
Session 16	393
Review part III	393
Session 17	393
Session 18	396
Session 19	396
Session 20	397
Review part IV	398
Session 21	398
Session 22	399
Session 23	400
Session 24	400
Session 25	401
Review part V	401
References	402
Important formulas used in precalculus	403
Index	411

Part I

Functions and graphs

Session 1

Absolute value equations and inequalities

1.1 Background regarding numbers

The **natural numbers** (denoted by \mathbb{N}) are the numbers

$$1, 2, 3, 4, 5, \dots$$

The **integers** (denoted by \mathbb{Z}) are the numbers

$$\dots, -4, -3, -2, -1, 0, 1, 2, 3, 4, 5, \dots$$

The **rational numbers** (denoted by \mathbb{Q}) are the fractions $\frac{a}{b}$ of integers a and b with $b \neq 0$. Here are some examples of rational numbers:

$$\frac{3}{5}, -\frac{2}{6}, 17, 0, \frac{3}{-8}$$

The **real numbers** (denoted by \mathbb{R}) are the numbers on the real number line

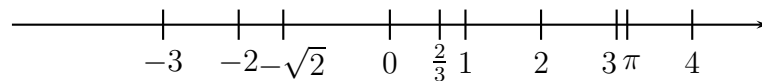

Here are some examples of real numbers:

$$\sqrt{3}, \pi, -\frac{2}{5}, 18, 0, 6.789$$

A real number that is not a rational number is called an **irrational number**. Here are some examples of irrational numbers:

$$\pi, \sqrt{2}, 5^{\frac{2}{3}}, e$$

1.2 The absolute value

The **absolute value** of a real number c , denoted by $|c|$ the non-negative number which is equal in magnitude (or size) to c , i.e., is the number resulting from disregarding the sign:

$$|c| = \begin{cases} c, & \text{if } c \text{ is positive or zero} \\ -c, & \text{if } c \text{ is negative} \end{cases}$$

Example 1.1. $|-4| = 4$

Example 1.2. $|12| = 12$

Example 1.3. $|-3.523| = 3.523$

Example 1.4. For which real numbers x do you have $|x| = 3$?

Solution. Since $|3| = 3$ and $|-3| = 3$, we see that there are two solutions, $x = 3$ or $x = -3$. The solution set is $S = \{-3, 3\}$. \square

Example 1.5. Solve for x : $|x| = 5$

Solution. $x = 5$ or $x = -5$. The solution set is $S = \{-5, 5\}$. \square

Example 1.6. Solve for x : $|x| = -7$.

Solution. Note that $|-7| = 7$ and $|7| = 7$ so that these cannot give any solutions. Indeed, **there are no solutions**, since the absolute value is always non-negative. The solution set is the empty set $S = \{\}$. \square

Example 1.7. Solve for x : $|x| = 0$.

Solution. Since $-0 = 0$, there is only one solution, $x = 0$. Thus, $S = \{0\}$. \square

Example 1.8. Solve for x : $|x + 2| = 6$.

Solution. Since the absolute value of $x + 2$ is 6, we see that $x + 2$ has to be either 6 or -6 . We evaluate each case,

$$\begin{array}{l|l} \text{either } x + 2 = 6, & \text{or } x + 2 = -6, \\ \implies x = 6 - 2, & \implies x = -6 - 2, \\ \implies x = 4; & \implies x = -8. \end{array}$$

The solution set is $S = \{-8, 4\}$. □

Example 1.9. Solve for x : $|3x - 4| = 5$

Solution.

$$\begin{array}{l|l} \text{Either } 3x - 4 = 5 & \text{or } 3x - 4 = -5 \\ \implies 3x = 9 & \implies 3x = -1 \\ \implies x = 3 & \implies x = -\frac{1}{3} \end{array}$$

The solution set is $S = \{-\frac{1}{3}, 3\}$. □

Example 1.10. Solve for x : $-2 \cdot |12 + 3x| = -18$

Solution. Dividing both sides by -2 gives $|12 + 3x| = 9$. With this, we have the two cases

$$\begin{array}{l|l} \text{Either } 12 + 3x = 9 & \text{or } 12 + 3x = -9 \\ \implies 3x = -3 & \implies 3x = -21 \\ \implies x = -1 & \implies x = -7 \end{array}$$

The solution set is $S = \{-7, -1\}$. □

1.3 Inequalities and intervals







There is an order relation on the set of real numbers:

$$\begin{array}{ll} 4 < 9 & \text{reads as } 4 \text{ is less than } 9, \\ -3 \leq 2 & \text{reads as } -3 \text{ is less than or equal to } 2, \\ \frac{7}{6} > 1 & \text{reads as } \frac{7}{6} \text{ is greater than } 1, \\ 2 \geq -3 & \text{reads as } 2 \text{ is greater than or equal to } -3. \end{array}$$

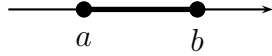
Example 1.11. We have $2 < 3$, but $-2 > -3$, which can be seen on the number line above.

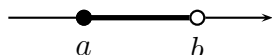
Example 1.12. We have $5 \leq 5$ and $5 \geq 5$. However the same is not true when using the symbol $<$. We write this as $5 \not< 5$.

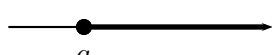
The set of all real numbers x greater than or equal to some number a and/or less than or equal to some number b is denoted in different ways by the following chart:

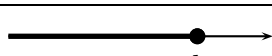
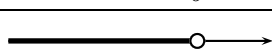
Inequality notation	Number line	Interval notation
$a \leq x \leq b$		$[a, b]$
$a < x < b$		(a, b)
$a \leq x < b$		$[a, b)$
$a < x \leq b$		$(a, b]$
$a \leq x$		$[a, \infty)$
$a < x$		(a, ∞)
$x \leq b$		$(-\infty, b]$
$x < b$		$(-\infty, b)$

Formally, we define the interval $[a, b]$ to be the set of all real numbers x such that $a \leq x \leq b$:

$$[a, b] = \{ x \mid a \leq x \leq b \}$$

There are similar definitions for the other intervals shown in the above table.

Warning 1.13. Be sure to write the smaller number $a < b$ first when writing an interval $[a, b]$. For example, the interval $[5, 3] = \{ x \mid 5 \leq x \leq 3 \}$ would be the empty set!

Example 1.14. Graph the the inequality $\pi < x \leq 5$ on the number line and write it in interval notation.

Solution.

On the number line:

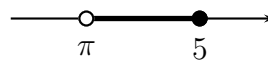

Interval notation:

$$(\pi, 5]$$

□

Example 1.15. Write the following interval as an inequality and in interval notation:

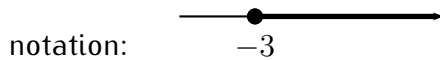

Solution.

Inequality notation: $-3 \leq x$

Interval notation: $[-3, \infty)$

□

Example 1.16. Write the following interval as an inequality and in interval notation:

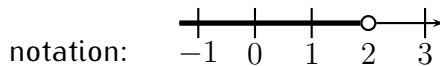

Solution.

Inequality notation: $x < 2$

Interval notation: $(-\infty, 2)$

□

Note 1.17. In some texts round and square brackets are also used on the number line to depict an interval. For example the following displays the interval $[2, 5)$.

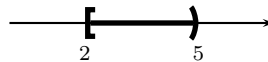

1.4 Absolute value inequalities

Using the notation from the previous section, we now solve *inequalities* involving the absolute value. These inequalities may be solved in three steps:

- **Step 1:** Solve the corresponding *equality*. The solution of the equality divides the real number line into several subintervals.
- **Step 2:** Using step 1, *check* the inequality for a number in *each* of the subintervals. This check determines the intervals of the solution set.
- **Step 3:** Check the endpoints of the intervals.

Here are some examples for the above solution method.

Example 1.18. Solve for x :

$$\text{a) } |x + 7| < 2 \quad \text{b) } |3x - 5| \geq 11 \quad \text{c) } |12 - 5x| \leq 1$$

Solution. a) We follow the three steps described above. In step 1, we solve the corresponding equality, $|x + 7| = 2$.

$$\begin{array}{l|l} x + 7 = 2 & x + 7 = -2 \\ \implies x = -5 & \implies x = -9 \end{array}$$

The solutions $x = -5$ and $x = -9$ divide the number line into three subintervals:

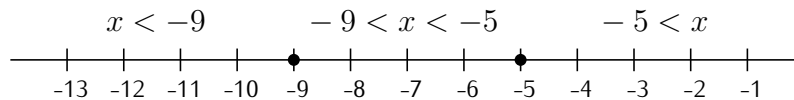

Now, in step 2, we check the inequality for one number in each of these subintervals.

Check: $x = -10$ $ (-10) + 7 \stackrel{?}{<} 2$ $ -3 \stackrel{?}{<} 2$ $3 \stackrel{?}{<} 2$ false	Check: $x = -7$ $ (-7) + 7 \stackrel{?}{<} 2$ $ 0 \stackrel{?}{<} 2$ $0 \stackrel{?}{<} 2$ true	Check: $x = 0$ $ 0 + 7 \stackrel{?}{<} 2$ $ 7 \stackrel{?}{<} 2$ $7 \stackrel{?}{<} 2$ false
---	---	--

Since $x = -7$ in the subinterval given by $-9 < x < -5$ solves the inequality $|x+7| < 2$, it follows that *all* numbers in the subinterval given by $-9 < x < -5$ solve the inequality. Similarly, since $x = -10$ and $x = 0$ do not solve the inequality, *no* number in these subintervals will solve the inequality. For step 3, we note that the numbers $x = -9$ and $x = -5$ are not included as solutions since the inequality is strict (that is we have $<$ instead of \leq). The solution set is therefore the interval $S = (-9, -5)$. The solution on the number line is:

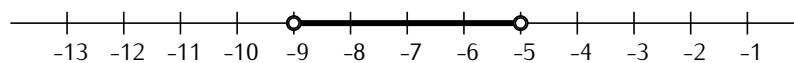

b) We follow the steps as before. First, in step 1, we solve $|3x - 5| = 11$.

$$\begin{array}{l|l} 3x - 5 = 11 & 3x - 5 = -11 \\ \implies 3x = 16 & \implies 3x = -6 \\ \implies x = \frac{16}{3} & \implies x = -2 \end{array}$$

The two solutions $x = -2$ and $x = \frac{16}{3} = 5\frac{1}{3}$ divide the number line into the subintervals displayed below.

$$x < -2 \qquad -2 < x < 5\frac{1}{3} \qquad 5\frac{1}{3} < x$$

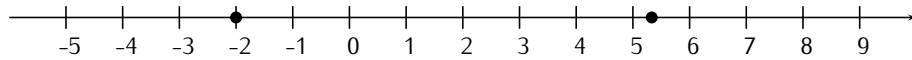

For step 2, we check a number in each subinterval. This gives:

Check: $x = -3$ $ 3 \cdot (-3) - 5 \stackrel{?}{\geq} 11$ $ -9 - 5 \stackrel{?}{\geq} 11$ $ -14 \stackrel{?}{\geq} 11$ $14 \stackrel{?}{\geq} 11$ true	Check: $x = 1$ $ 3 \cdot 1 - 5 \stackrel{?}{\geq} 11$ $ 3 - 5 \stackrel{?}{\geq} 11$ $ -2 \stackrel{?}{\geq} 11$ $2 \stackrel{?}{\geq} 11$ false	Check: $x = 6$ $ 3 \cdot 6 - 5 \stackrel{?}{\geq} 11$ $ 18 - 5 \stackrel{?}{\geq} 11$ $ 13 \stackrel{?}{\geq} 11$ $13 \stackrel{?}{\geq} 11$ true
--	--	---

For step 3, note that we include -2 and $5\frac{1}{3}$ in the solution set since the inequality is “greater than or equal to” (that is \geq , as opposed to $>$). Furthermore, the numbers $-\infty$ and ∞ are not included, since $\pm\infty$ are not real numbers.

The solution set is therefore the *union* of the two intervals:

$$S = \left(-\infty, -2\right] \cup \left[5\frac{1}{3}, \infty\right)$$

c) To solve $|12 - 5x| \leq 1$, we first solve the equality $|12 - 5x| = 1$.

$$\begin{array}{l|l} 12 - 5x = 1 & 12 - 5x = -1 \\ \implies -5x = -11 & \implies -5x = -13 \\ \implies x = \frac{-11}{-5} = 2.2 & \implies x = \frac{-13}{-5} = 2.6 \end{array}$$

This divides the number line into three subintervals, and we check the original inequality $|12 - 5x| \leq 1$ for a number in each of these subintervals.

Interval: $x < 2.2$ Check: $x = 1$ $ 12 - 5 \cdot 1 \stackrel{?}{\leq} 1$ $ 12 - 5 \stackrel{?}{\leq} 1$ $ 7 \stackrel{?}{\leq} 1$ $7 \stackrel{?}{\leq} 1$ false	Interval: $2.2 < x < 2.6$ Check: $x = 2.4$ $ 12 - 5 \cdot 2.4 \stackrel{?}{\leq} 1$ $ 12 - 12 \stackrel{?}{\leq} 1$ $ 0 \stackrel{?}{\leq} 1$ $0 \stackrel{?}{\leq} 1$ true	Interval: $2.6 < x$ Check: $x = 3$ $ 12 - 5 \cdot 3 \stackrel{?}{\leq} 1$ $ 12 - 15 \stackrel{?}{\leq} 1$ $ -3 \stackrel{?}{\leq} 1$ $3 \stackrel{?}{\leq} 1$ false
--	--	--

The solution set is the interval $S = [2.2, 2.6]$, where we included $x = 2.2$ and $x = 2.6$ since the original inequality “less than or equal to” (\leq) includes the equality. \square

Note: Alternatively, whenever you have an absolute value inequality you can turn it into two inequalities. Here are a couple of examples.

Example 1.19. Solve for x : $|12 - 5x| \leq 1$

Solution. Note that $|12 - 5x| \leq 1$ implies that

$$-1 \leq 12 - 5x \leq 1$$

so that

$$-13 \leq -5x \leq -11$$

and by dividing by -5 (remembering to switch the direction of the inequalities when multiplying or dividing by a negative number) we see that

$$\frac{13}{5} \geq x \geq \frac{11}{5},$$

or in interval notation, we have the solution set

$$S = \left[\frac{11}{5}, \frac{13}{5} \right].$$

\square

Example 1.20. If $|x + 6| > 2$ then either $x + 6 > 2$ or $x + 6 < -2$ so that either $x > -4$ or $x < -8$ so that in interval notation the solution is $S = (-\infty, -8) \cup (-4, \infty)$.

Observation 1.21. There is a geometric interpretation of the absolute value on the number line as the distance between two numbers:



distance between a and b is $|b - a|$ which is also equal to $|a - b|$

This interpretation can also be used to solve absolute value equations and inequalities.

Example 1.22. Solve for x : a) $|x - 6| = 4$, b) $|x - 6| \leq 4$, c) $|x - 6| \geq 4$.

Solution. a) Consider the distance between x and 6 to be 4 on a number line:

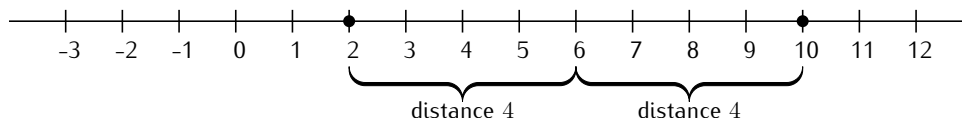

There are two solutions, $x = 2$ or $x = 10$. That is, the distance between 2 and 6 is 4 and the distance between 10 and 6 is 4.

b) Numbers inside the braces above have distance 4 or less. The solution is given on the number line as:

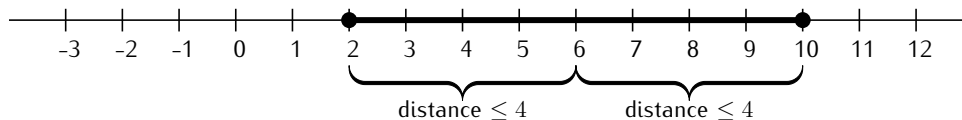

In interval notation, the solution set is the interval $S = [2, 10]$. One can also write that the solution set consists of all x such that $2 \leq x \leq 10$.

c) Numbers outside the braces above have distance 4 or more. The solution is given on the number line as:

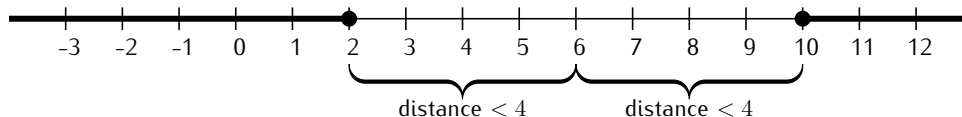

In interval notation, the solution set is the interval $(-\infty, 2]$ and $[10, \infty)$, or in short it is the union of the two intervals:

$$S = (-\infty, 2] \cup [10, \infty).$$

One can also write that the solution set consists of all x such that $x \leq 2$ or $x \geq 10$. \square

1.5 Exercises

Exercise 1.1. Give examples of numbers that are

- a) natural numbers b) integers c) integers but not natural numbers
 d) rational numbers e) real numbers f) rational numbers but not integers

Exercise 1.2. Which of the following numbers are natural numbers, integers, rational numbers, or real numbers? Which of these numbers are irrational?

- a) $\frac{7}{3}$ b) -5 c) 0 d) $17,000$ e) $\frac{12}{4}$ f) $\sqrt{7}$ g) $\sqrt{25}$

Exercise 1.3. Evaluate the following absolute value expressions:

- a) $|-8|$, b) $|10|$, c) $|-99|$, d) $-|3|$,
 e) $-|-2|$, f) $|-\sqrt{6}|$, g) $|3+4|$, h) $|2-9|$,
 i) $|-5.4|$, j) $|\frac{-2}{3}|$, k) $|\frac{5}{-2}|$, l) $-|-\frac{-6}{3}|$.



Exercise 1.4. Solve for x :

- a) $|x| = 8$ b) $|x| = 0$ c) $|x| = -3$
 d) $|x+3| = 10$ e) $|2x+5| = 9$ f) $|2-5x| = 22$
 g) $|4x| = -8$ h) $|-7x-3| = 0$ i) $|4-4x| = 44$
 j) $-2 \cdot |2-3x| = -12$ k) $5+|2x+7| = 14$ l) $-|-8-2x| = -12$

Exercise 1.5. Solve for x using the geometric interpretation of the absolute value:

- a) $|x| = 8$ b) $|x| = 0$ c) $|x| = -3$
 d) $|x-4| = 2$ e) $|x+5| = 9$ f) $|2-x| = 5$

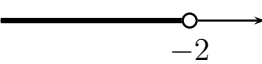
Exercise 1.6. Complete the table.

Inequality notation	Number line	Interval notation
$2 \leq x < 5$		
$x \leq 3$		
		
		
		$[-2, 6]$
		$(-\infty, 0)$
		
$5 < x \leq \sqrt{30}$		
		$(\frac{13}{7}, \pi)$

Exercise 1.7. Solve for x and write the solution in interval notation.

- a) $|x - 4| \leq 7$ b) $|x - 4| \geq 7$ c) $|x - 4| > 7$
 d) $|2x + 7| \leq 13$ e) $|-2 - 4x| > 8$ f) $|4x + 2| < 17$
 g) $|15 - 3x| \geq 6$ h) $|5x - \frac{4}{3}| > \frac{2}{3}$ i) $|\sqrt{2}x - \sqrt{2}| \leq \sqrt{8}$
 j) $|2x + 3| < -5$ k) $|5 + 5x| \geq -2$ l) $|5 + 5x| > 0$

Session 2

Lines and functions

2.1 Lines, slope and intercepts

In this chapter we will introduce the notion of a function. Before we give the general definition, we recall one special kind of function which is already familiar to the student. More precisely, we start by recalling functions that are given by straight lines.

We have seen in the last section that each point on the number line is represented by a real number x in \mathbb{R} . Similarly, each point in the coordinate plane is represented by a pair of real numbers (x, y) . The coordinate plane is denoted by \mathbb{R}^2 . Here is a picture of the coordinate plane:

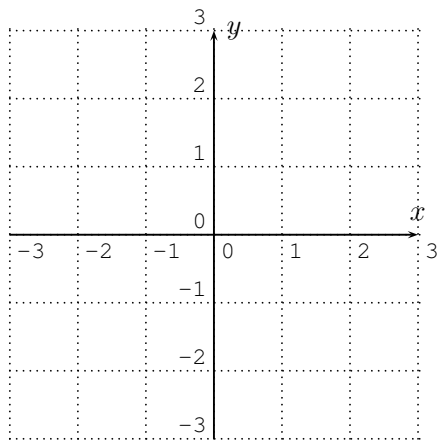

In this section, we will discuss the straight line in the coordinate plane. We will discuss its slope and intercepts. We will also discuss the line's

corresponding algebraic forms: the point-slope form and the slope-intercept form.

By drawing a line on a coordinate plane we associate every point on the line with a pair of numbers (a, b) , where a is called the x -coordinate and b is called the y -coordinate. Consider, for example, the picture

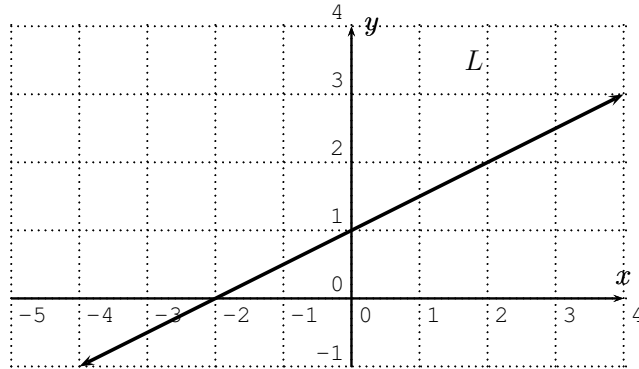

We see that $(-2, 0)$ lies on the line and so does $(2, 2)$. Of course, there are an infinite number of points on the line. This set of points can also be described by an equation relating the x - and y -coordinates of points on the line. For example $2y - x = 2$ is the equation of the line above. Notice that $(-2, 0)$ satisfies the equation since $2(0) - (-2) = 2$ and $(2, 2)$ satisfies the equation since $2(2) - (2) = 2$. It is a fact that every line has an equation of the form $px + qy = r$, that is, given a line, there are numbers p, q and r so that a point (a, b) is on the graph of the line if and only if $pa + qb = r$.

Notice that, in the example, if we put our finger on $(-2, 0)$ and move it up and over to the point $(2, 2)$ we have moved 2 units up and 4 units to the right. If from there $((2, 2))$ we move another 2 units up and 4 units to the right then we land again on the line (at $(6, 4)$). In fact no matter where we start on the line if from there we move 2 units up and 4 units to the right we always land on the line again. The ratio $\frac{\text{rise}}{\text{run}} = \frac{2}{4}$ is called the **slope** of this line. The word 'rise' indicates vertical movement (down being negative) and 'run' indicates horizontal movement (left being negative). Notice that $\frac{2}{4} = \frac{1}{2} = \frac{-1}{-2}$ and so on. So we could also see that if we start at $(-2, 0)$ and rise 1 and run 2 we land at $(0, 1)$ which is on the line and if we start at $(2, 2)$ and rise -1 (move down 1) and run -2 (move to the left 2) we end up at $(0, 1)$, which is again on the line.

Generally, the slope describes how fast the line grows towards the right. For any two points $P_1(x_1, y_1)$ and $P_2(x_2, y_2)$ on the line L , the slope m is

given by the following formula (which is $\frac{\text{rise}}{\text{run}}$):

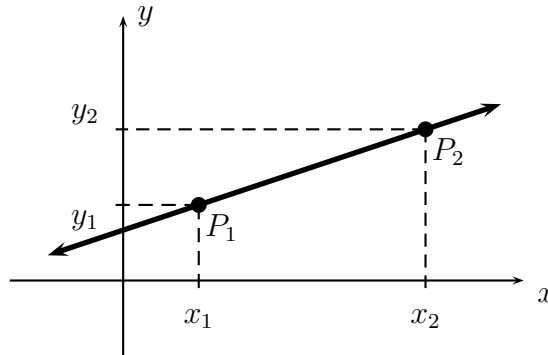

Slope:

$$m = \frac{y_2 - y_1}{x_2 - x_1}$$

(2.1)

The slope determines how fast a line grows. When the slope m is negative the line declines towards the right.

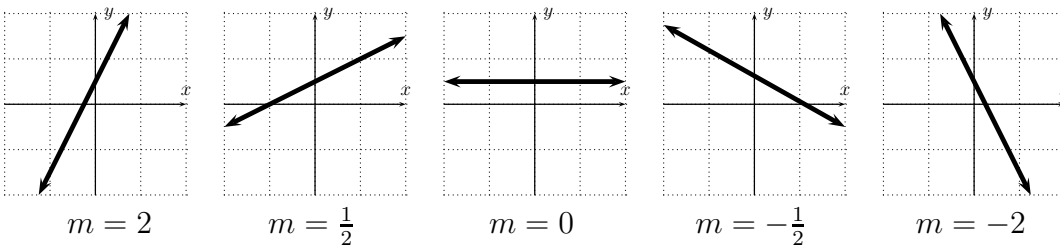

From equation (2.1), we see that for a given slope m and a point $P_1(x_1, y_1)$ on the line, any other point (x, y) on the line satisfies $m = \frac{y - y_1}{x - x_1}$. Multiplying $(x - x_1)$ on both sides gives what is called the **point-slope form of the line**:

$$y - y_1 = m \cdot (x - x_1)$$

(2.2)

Other prominent features of a graph of a line (or other graphs) include where the graph crosses the x -axis and the y -axis. For a given line L , let us recall what the x - and y -intercepts are. The **x -intercept** is the point on the x -axis where the line intersects the x -axis. Similarly, the **y -intercept** is the point on the y -axis where the line intersects the y -axis.

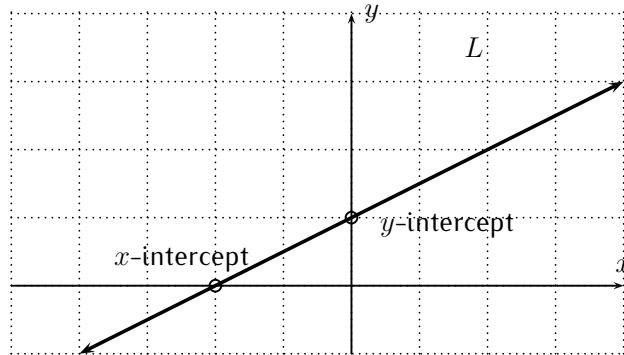

One way to describe a line using the slope and y -intercept is the so-called slope-intercept form of the line.

Definition 2.1. The **slope-intercept form of the line** is the equation

$$\boxed{y = m \cdot x + b} \quad (2.3)$$

Here, m is the **slope** and $(0, b)$ is the **y -intercept** of the line.

Here is an example of a line in slope-intercept form.

Example 2.2. Graph the line $y = 2x + 3$.

Solution. We calculate y for various values of x . For example, when x is $-2, -1, 0, 1, 2,$ or 3 , we calculate

x	-2	-1	0	1	2	3
y	-1	1	3	5	7	9

In the above table each y value is calculated by substituting the corresponding x value into our equation $y = 2x + 3$:

$$\begin{aligned} x = -2 &\implies y = 2 \cdot (-2) + 3 = -4 + 3 = -1 \\ x = -1 &\implies y = 2 \cdot (-1) + 3 = -2 + 3 = 1 \\ x = 0 &\implies y = 2 \cdot (0) + 3 = 0 + 3 = 3 \\ x = 1 &\implies y = 2 \cdot (1) + 3 = 2 + 3 = 5 \\ x = 2 &\implies y = 2 \cdot (2) + 3 = 4 + 3 = 7 \\ x = 3 &\implies y = 2 \cdot (3) + 3 = 6 + 3 = 9 \end{aligned}$$

In the above calculation, the values for x were arbitrarily chosen. Since a line is completely determined by knowing two points on it, any two values for x would have worked for the purpose of graphing the line.

Drawing the above points in the coordinate plane and connecting them gives the graph of the line $y = 2x + 3$:

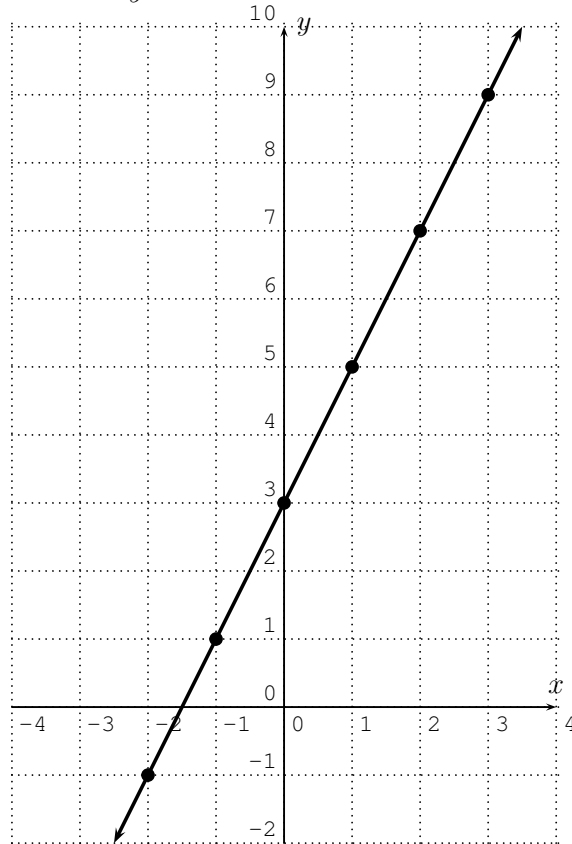

Alternatively, note that the y -intercept is $(0, 3)$ (3 is the additive constant in our initial equation $y = 2x + 3$) and the slope $m = 2$ determines the rate at which the line grows: for each step to the right, we have to move two steps up.

To plot the graph, we first plot the y -intercept $(0, 3)$. Then from that point, rise 2 and run 1 so that you find yourself at $(1, 5)$ (which must be on the graph), and similarly rise 2 and run 1 to get to $(2, 7)$ (which must be on the graph), etc. Plot these points on the graph and connect the dots to form a straight line. As noted above, any 2 distinct points on the graph of a straight line are enough to plot the complete line. \square

Before giving more examples, we briefly want to justify why, in the expression $y = mx + b$, the number $(0, b)$ is the y -intercept and m is the slope. This proof may be skipped on a first reading.

Proof that $(0, b)$ is the y -intercept, and m is the slope.

Given the line $y = mx + b$, we want to calculate its y -intercept and its slope. The y -intercept is the value of y where $x = 0$. Therefore, we have that the y -coordinate of the y -intercept is

$$y = m \cdot 0 + b = b.$$

This shows the first claim.

Next, to see why m is the slope, note that $P_1(x_1, y_1)$ lies on the line exactly when $y_1 = mx_1 + b$. Similarly, $P_2(x_2, y_2)$ lies on the line exactly when $y_2 = mx_2 + b$. Subtracting $y_1 = mx_1 + b$ from $y_2 = mx_2 + b$, we obtain:

$$y_2 - y_1 = (mx_2 + b) - (mx_1 + b) = mx_2 + b - mx_1 - b = m \cdot (x_2 - x_1).$$

Dividing by $(x_2 - x_1)$ gives

$$\frac{y_2 - y_1}{(x_2 - x_1)} = \frac{m \cdot (x_2 - x_1)}{(x_2 - x_1)} = \frac{m}{1} = m.$$

By Equation (2.1) the fraction $\frac{y_2 - y_1}{x_2 - x_1}$ is the slope, establishing that our m is indeed the slope, as we claimed. \square

Example 2.3. Find the equation of the line in slope-intercept form.

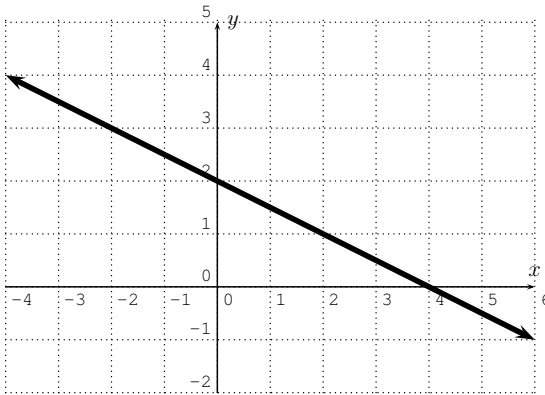

Solution. The y -intercept can be read off the graph giving us that $b = 2$. As for the slope, we use formula (2.1) and the two points on the line $P_1(0, 2)$ and $P_2(4, 0)$. We obtain

$$m = \frac{0 - 2}{4 - 0} = \frac{-2}{4} = -\frac{1}{2}.$$

Thus, the line has the slope-intercept form $y = -\frac{1}{2}x + 2$. \square

Example 2.4. Find the equation of the line in slope-intercept form.

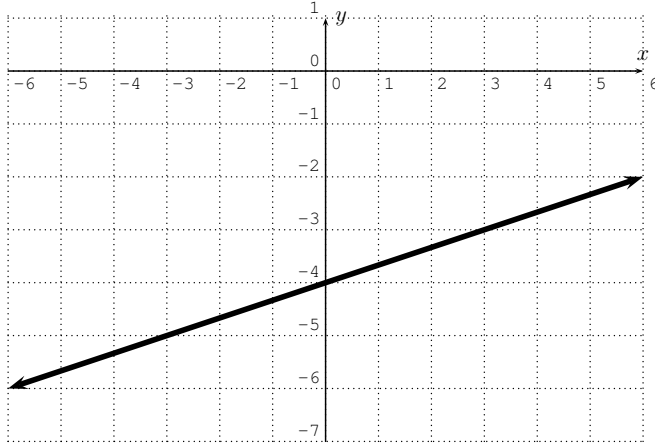

Solution. The y -intercept is $b = -4$. To obtain the slope we can again use the y -intercept $P_1(0, -4)$. To use (2.1), we need another point P_2 on the line. We may pick any second point on the line, for example, $P_2(3, -3)$. With this, we obtain

$$m = \frac{(-3) - (-4)}{3 - 0} = \frac{-3 + 4}{3} = \frac{1}{3}.$$

Thus, the line has the slope-intercept form $y = \frac{1}{3}x - 4$. \square

Example 2.5. Find the equation of the line in point-slope form (2.2).

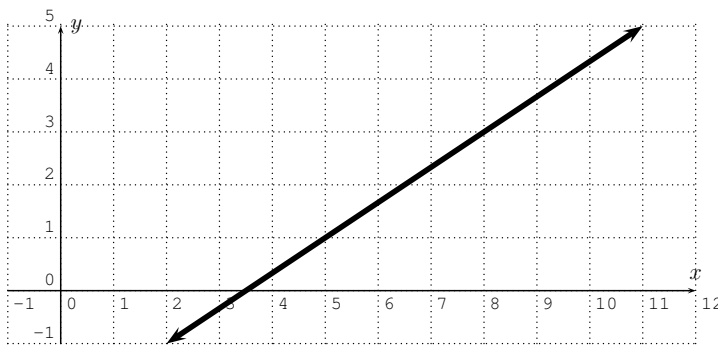

Solution. We need to identify one point (x_1, y_1) on the line together with the slope m of the line so that we can write the line in point-slope form: $y - y_1 = m(x - x_1)$. By direct inspection, we identify the two points $P_1(5, 1)$ and $P_2(8, 3)$ on the line, and with this we calculate the slope as

$$m = \frac{3 - 1}{8 - 5} = \frac{2}{3}.$$

Using the point $(5, 1)$ we write the line in point-slope form as follows:

$$y - 1 = \frac{2}{3}(x - 5)$$

Note that our answer depends on the chosen point $(5, 1)$ on the line. Indeed, if we choose a different point on the line, such as $(8, 3)$, we obtain a different equation, (which nevertheless represents the same line):

$$y - 3 = \frac{2}{3}(x - 8)$$

Note, that we do *not* need to solve this for y , since we are looking for an answer in point-slope form. \square

Example 2.6. Find the slope, find the y -intercept, and graph the line

$$4x + 2y - 2 = 0.$$

Solution. We first rewrite the equation in slope-intercept form.

$$\begin{aligned} 4x + 2y - 2 = 0 & \xrightarrow{(-4x+2)} 2y = -4x + 2 \\ & \xrightarrow{(\text{divide } 2)} y = -2x + 1 \end{aligned}$$

We see that the slope is -2 and the y -intercept is $(0, 1)$.

We can then plot the y -intercept $(0, 1)$ and use the slope $m = \frac{-2}{1}$ to find another point $(1, -1)$. Plot that point, connect the two plotted points, and extend to see the graph below.

We can also graph by plotting points. We can calculate the y -values for some x -values. For example when $x = -2, -1, \dots, 3$, we obtain:

x	-2	-1	0	1	2	3
y	5	3	1	-1	-3	-5

This gives the following graph:

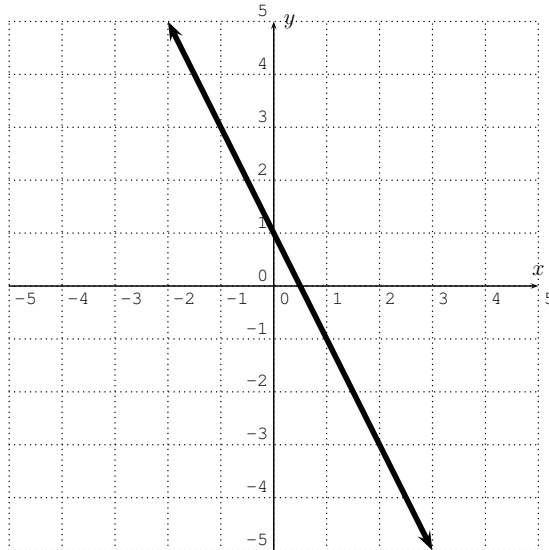

□

Example 2.7. Find the slope, y -intercept, and graph the line $5y + 2x = -10$.

Solution. Again, we first rewrite the equation in slope-intercept form.

$$\begin{aligned}
 5y + 2x &= -10 && \xrightarrow{\text{(subtract } 2x\text{)}} && 5y = -2x - 10 \\
 &&& \xrightarrow{\text{(divide 5)}} && y = \frac{-2x - 10}{5} \\
 &&& \implies && y = -\frac{2}{5}x - 2
 \end{aligned}$$

Now, the slope is $-\frac{2}{5}$ and the y -intercept is $(0, -2)$.

We can plot the y -intercept and from there move 2 units down and 5 units to the right to find another point on the line. The graph is given below.

To graph it by plotting points we need to find points on the line. In fact, any two points will be enough to completely determine the graph of the line. For some “smart” choices of x or y the calculation of the corresponding value may be easier than for others. We suggest that you find the x - and y -intercepts, i.e., point of the form $(?, 0)$ ($y = 0$ in the equation and find x) and $(0, ?)$ (set $x = 0$ in the equation and find y). Plugging $x = 0$ into $5y + 2x = -10$, we obtain

$$\xrightarrow{x=0} 5y + 2 \cdot 0 = -10 \quad \implies 5y = -10 \quad \implies y = -2.$$

Similarly, substituting $y = 0$ into $5y + 2x = -10$ gives

$$\stackrel{y=0}{\implies} 5 \cdot 0 + 2x = -10 \quad \implies 2x = -10 \quad \implies x = -5.$$

We obtain the following table:

x	0	-5
y	-2	0

This gives the following graph:

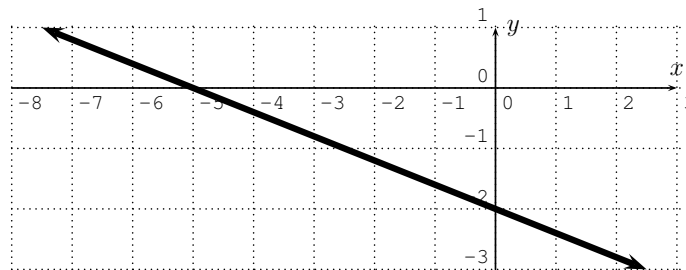

□

2.2 Introduction to functions

We now formally introduce the notion of a function. A first example was provided by a straight line such as, for example, $y = 5x + 4$. Note, that for each given x we obtain an induced y . (For example, for $x = 3$, we obtain $y = 5 \cdot 3 + 4 = 19$.)

Definition 2.8. A **function** f consists of two sets, a set D of **inputs** called the **domain** and a set C of possible **outputs** called the **codomain**, and an assignment that assigns to each input x exactly one output y .

A function f with domain D and codomain C is denoted by

$$f : D \rightarrow C.$$

If x is in the domain D (an input), then we denote by $f(x) = y$ the output that is assigned by f to x .

Sometimes it is of interest to know the set of all elements in the codomain that actually occur as an output. This set is a subset of the codomain and is called the range. We have:

Definition 2.9. The **range** R of a function f is a subset of the codomain given by $R = \{f(x) \mid x \text{ in the domain of } f\}$. That is, the range is the set of all outputs.

Warning 2.10. Some authors use a slightly different convention by calling the range what we called the codomain above.

Since we will be dealing with many functions it is convenient to name various functions (usually with letters f, g, h , etc). Often we will implicitly assume that a domain and codomain are given without specifying these explicitly. If the range can be determined and the codomain is not given explicitly, then we take the codomain to be the range. If the range can not easily be determined and the codomain is not explicitly given, then the codomain should be taken to be a 'simple' set which clearly contains the range.

There are several ways to represent a particular function (all of which may not apply to a specific function): via a table of values (listing the input-output pairs), via a formula (with the domain and range explicitly or implicitly given), via a graph (representing input-output pairs on a coordinate plane), or in words, just to name a few. We have seen examples of the first three of these in previous sections. Our discussion in this section goes into greater detail.

Example 2.11. Define the assignment f by the following table

x	2	5	-3	0	7	4
y	6	8	6	4	-1	8

The assignment f assigns to the input 2 the output 6, which is also written as

$$f(2) = 6.$$

Similarly, f assigns to 5 the number 8, in short $f(5) = 8$, etc:

$$f(5) = 8, \quad f(-3) = 6, \quad f(0) = 4, \quad f(7) = -1, \quad f(4) = 8.$$

The domain D is the set of all inputs. The domain is therefore

$$D = \{-3, 0, 2, 4, 5, 7\}.$$

The range R is the set of all outputs. The range is therefore

$$R = \{-1, 4, 6, 8\}.$$

The assignment f is indeed a function since each element of the domain gets assigned exactly one element in the range. Note that for an input number that is not in the domain, f does not assign an output to it. For example,

$$f(1) = \text{undefined}.$$

Note also that $f(5) = 8$ and $f(4) = 8$, so that f assigns to the inputs 5 and 4 the same output 8. Similarly, f also assigns the same output to the inputs 2 and -3 . Therefore we see that:

- *A function may assign the same output to two different inputs!*

Example 2.12. Consider the assignment f that is given by the following table.

x	2	5	-3	0	5	4
y	6	8	6	4	-1	8

This assignment *does not define* a function! What went wrong?

Consider the input value 5. What does f assign to the input 5? The third column states that f assigns to 5 the output 8, whereas the sixth column states that f assigns to 5 the output -1 ,

$$f(5) = 8, \quad f(5) = -1.$$

However, by the definition of a function, to each input we have to assign *exactly one* output. So, here, to the input 5 we have assigned two outputs 8 and -1 . Therefore, f is not a function.

- *A function cannot assign two outputs to one input!*

We repeat the two bullet points from the last two examples, which are crucial for the understanding of a function.

Note 2.13.

- *A function may assign the same output to two different inputs!*

$$f(x_1) = y \quad \text{and} \quad f(x_2) = y \quad \text{with } x_1 \neq x_2 \text{ is allowed!}$$

- *A function cannot assign two outputs to one input!*

$$f(x) = y_1 \quad \text{and} \quad f(x) = y_2 \quad \text{with} \quad y_1 \neq y_2 \quad \text{is not allowed!}$$

Example 2.14. A university creates a mentoring program, which matches each freshman student with a senior student as his or her mentor. Within this program it is guaranteed that each freshman gets precisely one mentor, however two freshmen may receive the same mentor. Does the assignment of freshmen to mentor, or mentor to freshmen describe a function? If so, what is its domain, what is its range?

Solution. Since a senior may mentor several freshmen, we cannot take a mentor as an “input,” as he or she would be assigned to several “output” freshmen students. So freshman is not a function of mentor.

On the other hand, we can assign each freshmen to exactly one mentor, which therefore describes a function. The domain (the set of all inputs) is given by the set of all freshmen students. The range (the set of all outputs) is given by the set of all senior students that are mentors. The function assigns each “input” freshmen student to his or her unique “output” mentor. \square

Example 2.15. The rainfall in a city for each of the 12 months is displayed in the following histogram.

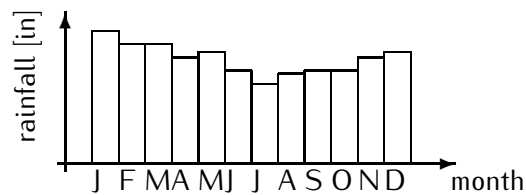

- Is the rainfall a function of the month?
- Is the month a function of the rainfall?

Solution.

- Each month has exactly one amount of rainfall associated to it. Therefore, the assignment that associates to a month its rainfall (in inches) is a function.

- b) If we take a certain rainfall amount as our input data, can we associate a unique month to it? For example, February and March have the same amount of rainfall. Therefore, to one input amount of rainfall we cannot assign a unique month. The month is *not* a function of the rainfall.

□

Example 2.16. Consider the function f described below.

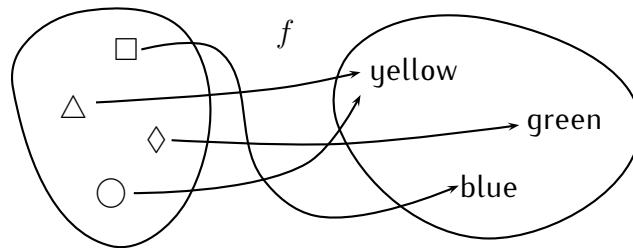

Here, the function f maps the input symbol \square to the output color blue. Other assignments of f are as follows:

$$\begin{aligned} f(\square) &= \text{blue}, & f(\triangle) &= \text{yellow} \\ f(\diamond) &= \text{green}, & f(\circ) &= \text{yellow} \end{aligned}$$

The domain is the set of symbols $D = \{\square, \triangle, \diamond, \circ\}$, and the range is the set of colors $R = \{\text{blue}, \text{green}, \text{yellow}\}$. Notice, in particular, that the inputs \triangle and \circ both have the same output yellow, which is certainly allowed for a function.

Example 2.17. Consider the function $y = 5x + 4$ with domain all real numbers and range all real numbers. Note that for each input x , we obtain an exactly one induced output y . For example, for the input $x = 3$ we get the output $y = 5 \cdot 3 + 4 = 19$, etc.

Example 2.18. Consider the function $y = x^2$ with domain all real numbers and range non-negative numbers. The function takes a real number as an input and squares it. For example if $x = -2$ is the input, then $y = 4$ is the output.

Example 2.19. For each real number x , denote by $\lfloor x \rfloor$ the greatest integer that is less or equal to x . We call $\lfloor x \rfloor$ the **floor of x** . For example, to calculate $\lfloor 4.37 \rfloor$, note that all integers $4, 3, 2, \dots$ are less or equal to 4.37 :

$$\dots, -3, -2, -1, 0, 1, 2, 3, 4 \leq 4.37$$

The greatest of these integers is 4, so that $\lfloor 4.37 \rfloor = 4$. We define the **floor function** as $f(x) = \lfloor x \rfloor$. Here are more examples of function values of the floor function.

$$\begin{aligned} \lfloor 7.3 \rfloor &= 7, & \lfloor \pi \rfloor &= 3, & \lfloor -4.65 \rfloor &= -5, \\ \lfloor 12 \rfloor &= 12, & \left\lfloor \frac{-26}{3} \right\rfloor &= \lfloor -8.667 \rfloor &= -9 \end{aligned}$$

The domain of the floor function is the set of all real numbers, that is $D = \mathbb{R}$. The range is the set of all integers, $R = \mathbb{Z}$.

Example 2.20. Let A be the area of an isosceles right triangle with base side length x . Express A as a function of x .

Solution. Being an isosceles right triangle means that two side lengths are x , and the angles are 45° , 45° , and 90° (or in radian measure $\frac{\pi}{4}$, $\frac{\pi}{4}$, and $\frac{\pi}{2}$):

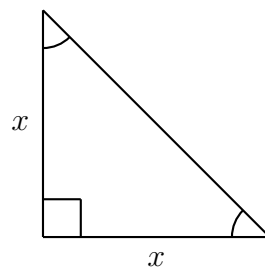

Recall that the area of a triangle is: $\text{area} = \frac{1}{2} \text{base} \cdot \text{height}$. In this case, we have $\text{base} = x$, and $\text{height} = x$, so that the area

$$A = \frac{1}{2}x \cdot x = \frac{1}{2}x^2.$$

Therefore, the area $A(x) = \frac{1}{2} \cdot x^2$. □

Example 2.21. Consider the equation $y = x^2 + 3$. This equation associates to each input number a exactly one output number $b = a^2 + 3$. Therefore, the equation defines a function. For example:

To the input 5 we assign the output $5^2 + 3 = 25 + 3 = 28$.

The domain D is all real numbers, $D = \mathbb{R}$. Since x^2 is always ≥ 0 , we see that $x^2 + 3 \geq 3$, and vice versa every number $y \geq 3$ can be written as $y = x^2 + 3$. (To see this, note that the input $x = \sqrt{y-3}$ for $y \geq 3$ gives the output $x^2 + 3 = (\sqrt{y-3})^2 + 3 = y - 3 + 3 = y$.) Therefore, the range is $R = [3, \infty)$.

Example 2.22. Consider the equation $x^2 + y^2 = 25$. Does this equation define y as a function of x ? That is, does this equation assign to each input x exactly one output y ?

An input number x gets assigned to y with $x^2 + y^2 = 25$. Solving this for y , we obtain

$$y^2 = 25 - x^2 \quad \implies \quad y = \pm\sqrt{25 - x^2}.$$

Therefore, there are *two* possible outputs associated to the input x ($\neq 5$):

$$\text{either } y = +\sqrt{25 - x^2} \quad \text{or} \quad y = -\sqrt{25 - x^2}.$$

For example, the input $x = 0$ has two outputs $y = 5$ and $y = -5$. However, a function cannot assign two outputs to one input x ! The conclusion is that $x^2 + y^2 = 25$ does *not* determine y as a function!

Note 2.23. Note that if $y = f(x)$ then x is called the **independent variable** and y is called the **dependent variable** (since it depends on x). If $x = g(y)$ then y is the independent variable and x is the dependent variable (since it depends on y).

2.3 Exercises

Exercise 2.1. Find the slope and y -intercept of the line with the given data. Using the slope and y -intercept, write the equation of the line in slope-

intercept form.

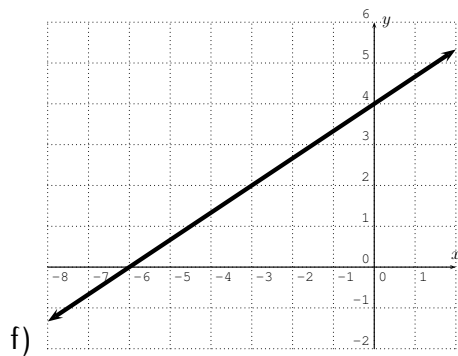
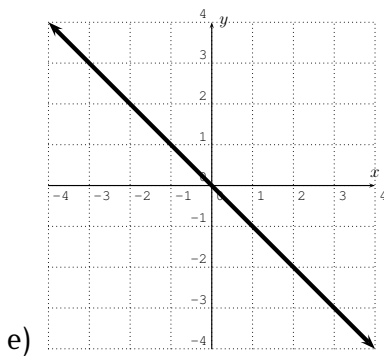
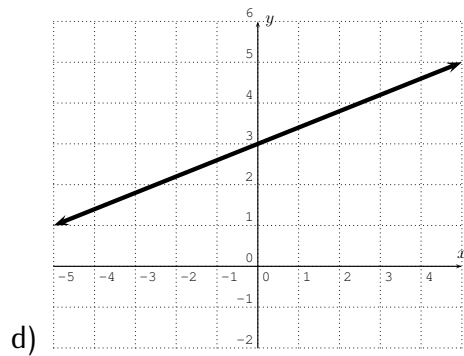
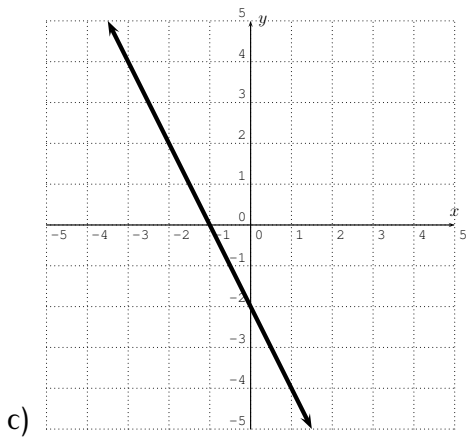
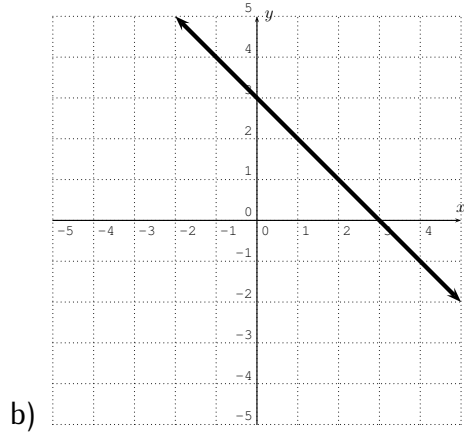
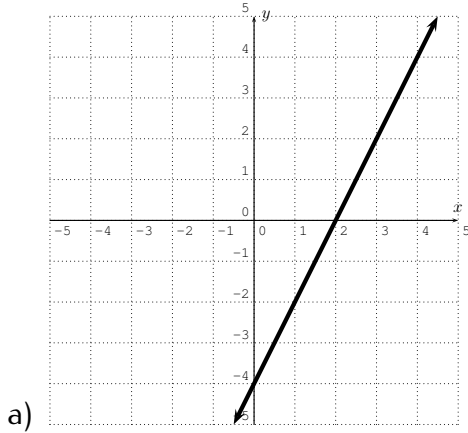

Exercise 2.2. Write the equation of the line in slope-intercept form. Identify slope and y -intercept of the line.

- a) $4x + 2y = 8$ b) $9x - 3y + 15 = 0$ c) $-5x - 10y = 20$
 d) $3x - 5y = 7$ e) $-12x + 8y = -60$ f) $8x - 9y = 0$

Exercise 2.3. Find the equation of the line in point-slope form (2.2) using the indicated point P_1 .

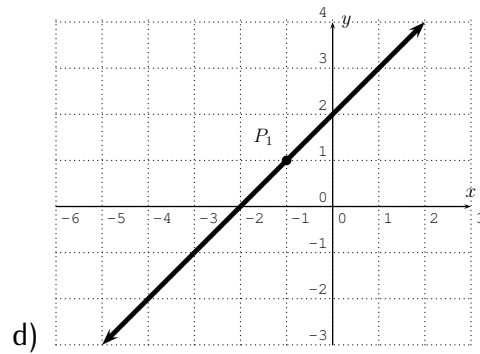
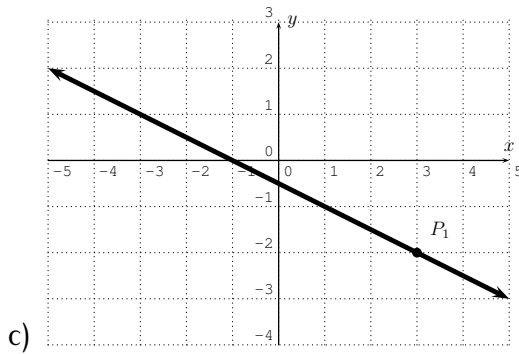
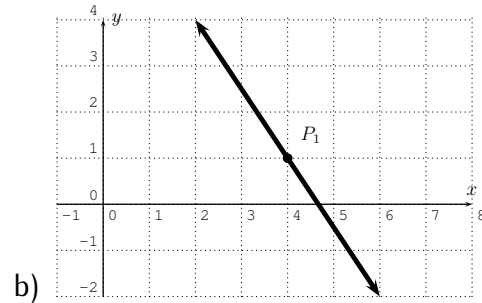
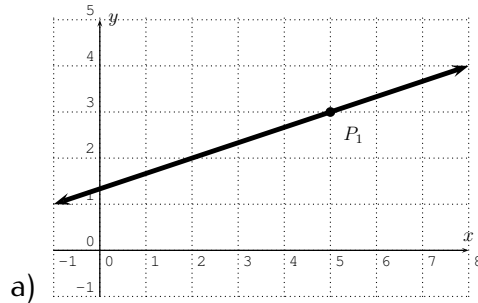

Exercise 2.4. Graph the line by calculating a table (as in Example 2.2). (Solve for y first, if this is necessary.)

a) $y = 2x - 4$ b) $y = -x + 4$ c) $y = \frac{1}{2}x + 1$
 d) $y = 3x$ e) $8x - 4y = 12$ f) $x + 3y + 6 = 0$

Exercise 2.5. Determine if the given table describes a function. If so, determine its domain and range. Describe which outputs are assigned to which inputs.

a)

x	-5	3	-1	6	0
y	5	2	8	3	7

b)

x	6	17	4	-2	4
y	8	-2	0	3	-1

c)

x	19	7	6	-2	3	-11
y	3	3	3	3	3	3

d)

x	1	2	3	3	4	5
y	5.33	9	13	13	17	$\sqrt{19}$

e)

x	0	1	2	2	3	4
y	0	1	2	3	3	4

Exercise 2.6. We consider children and their (birth) mothers.

- Does the assignment child to their birth mother constitute a function (in the sense of Definition 2.8 on page 22)?
- Does the assignment mother to their children constitute a function?
- In the case where the assignment is a function, what is the domain?
- In the case where the assignment is a function, what is the range?

Exercise 2.7. A bank offers wealthy customers a certain amount of interest, if they keep more than 1 million dollars in their account. The amount is described in the following table.

dollar amount x in the account	interest amount
$x \leq \$1,000,000$	\$0
$\$1,000,000 < x \leq \$10,000,000$	2% of x
$\$10,000,000 < x$	1% of x

- Justify that the assignment cash amount to interest defines a function.
- Find the interest for an amount of:
 - \$50,000
 - \$5,000,000
 - \$1,000,000
 - \$30,000,000
 - \$10,000,000
 - \$2,000,000

Exercise 2.8. Find a formula for a function describing the given inputs and outputs.

- input*: the radius of a circle,
output: the circumference of the circle
- input*: the side length in an equilateral triangle,
output: the perimeter of the triangle
- input*: one side length of a rectangle, with other side length being 3,
output: the perimeter of the rectangle
- input*: the side length of a cube,
output: the volume of the cube

Session 3

Functions by formulas and graphs

3.1 Functions given by formulas

Most of the time we will discuss functions that take some real numbers as inputs, and give real numbers as outputs. These functions are commonly described with a formula.

Example 3.1. For the given function f , calculate the outputs $f(2)$, $f(-3)$, and $f(-1)$.

$$\begin{array}{ll} \text{a) } f(x) = 3x + 4, & \text{b) } f(x) = \sqrt{x^2 - 3}, \\ \text{c) } f(x) = \begin{cases} 5x - 6 & , \text{ for } -1 \leq x \leq 1 \\ x^3 + 2x & , \text{ for } 1 < x \leq 5 \end{cases} & \text{d) } f(x) = \frac{x+2}{x+3}. \end{array}$$

Solution. We substitute the input values into the function and simplify.

$$\begin{array}{l} \text{a) } \quad f(2) = 3 \cdot 2 + 4 = 6 + 4 = 10, \\ \quad \quad f(-3) = 3 \cdot (-3) + 4 = -9 + 4 = -5, \\ \quad \quad f(-1) = 3 \cdot (-1) + 4 = -3 + 4 = 1. \end{array}$$

b) Similarly, we calculate

$$\begin{array}{l} f(2) = \sqrt{2^2 - 3} = \sqrt{4 - 3} = \sqrt{1} = 1, \\ f(-3) = \sqrt{(-3)^2 - 3} = \sqrt{9 - 3} = \sqrt{6}, \\ f(-1) = \sqrt{(-1)^2 - 3} = \sqrt{1 - 3} = \sqrt{-2} = \text{undefined}. \end{array}$$

For the last step, we are assuming that we only deal with real numbers. Of course, as we will see later on, $\sqrt{-2}$ can be defined as a complex number. But for now, we will only allow real solutions outputs.

c) The function $f(x) = \begin{cases} 5x - 6 & , \text{ for } -1 \leq x \leq 1 \\ x^3 + 2x & , \text{ for } 1 < x \leq 5 \end{cases}$ is given as a piecewise defined function. We have to substitute the values into the correct branch:

$$f(2) = 2^3 + 2 \cdot 2 = 8 + 4 = 12, \text{ since } 1 < 2 \leq 5,$$

$$f(-3) = \text{undefined, since } -3 \text{ is not in any of the two branches,}$$

$$f(-1) = 5 \cdot (-1) - 6 = -5 - 6 = -11, \text{ since } -1 \leq -1 \leq 1.$$

d) Finally for $f(x) = \frac{x+2}{x+3}$, we have:

$$f(2) = \frac{2+2}{2+3} = \frac{4}{5},$$

$$f(-3) = \frac{-3+2}{-3+3} = \frac{-1}{0} = \text{undefined,}$$

$$f(-1) = \frac{-1+2}{-1+3} = \frac{1}{2}.$$

□

Example 3.2. Let f be the function given by $f(x) = x^2 + 2x - 3$. Find the following function values.

- | | | | |
|------------------|----------------------|----------------------------|----------------------------|
| a) $f(5)$ | b) $f(2)$ | c) $f(-2)$ | d) $f(0)$ |
| e) $f(\sqrt{5})$ | f) $f(\sqrt{3} + 1)$ | g) $f(a)$ | h) $f(a) + 5$ |
| i) $f(x + h)$ | j) $f(x + h) - f(x)$ | k) $\frac{f(x+h)-f(x)}{h}$ | l) $\frac{f(x)-f(a)}{x-a}$ |

Solution. The first four function values ((a)-(d)) can be calculated directly:

$$f(5) = 5^2 + 2 \cdot 5 - 3 = 25 + 10 - 3 = 32,$$

$$f(2) = 2^2 + 2 \cdot 2 - 3 = 4 + 4 - 3 = 5,$$

$$f(-2) = (-2)^2 + 2 \cdot (-2) - 3 = 4 + -4 - 3 = -3,$$

$$f(0) = 0^2 + 2 \cdot 0 - 3 = 0 + 0 - 3 = -3.$$

The next two values ((e) and (f)) are similar, but the arithmetic is a bit more involved.

$$f(\sqrt{5}) = \sqrt{5}^2 + 2 \cdot \sqrt{5} - 3 = 5 + 2 \cdot \sqrt{5} - 3 = 2 + 2 \cdot \sqrt{5},$$

$$\begin{aligned}
 f(\sqrt{3} + 1) &= (\sqrt{3} + 1)^2 + 2 \cdot (\sqrt{3} + 1) - 3 \\
 &= (\sqrt{3} + 1) \cdot (\sqrt{3} + 1) + 2 \cdot (\sqrt{3} + 1) - 3 \\
 &= \sqrt{3} \cdot \sqrt{3} + 2 \cdot \sqrt{3} + 1 \cdot 1 + 2 \cdot \sqrt{3} + 2 - 3 \\
 &= 3 + 2 \cdot \sqrt{3} + 1 + 2 \cdot \sqrt{3} + 2 - 3 \\
 &= 3 + 4 \cdot \sqrt{3}.
 \end{aligned}$$

The last five values ((g)-(l)) are purely algebraic:

$$\begin{aligned}
 f(a) &= a^2 + 2 \cdot a - 3, \\
 f(a) + 5 &= a^2 + 2 \cdot a - 3 + 5 = a^2 + 2 \cdot a + 2, \\
 f(x + h) &= (x + h)^2 + 2 \cdot (x + h) - 3 \\
 &= x^2 + 2xh + h^2 + 2x + 2h - 3, \\
 f(x + h) - f(x) &= (x^2 + 2xh + h^2 + 2x + 2h - 3) - (x^2 + 2x - 3) \\
 &= x^2 + 2xh + h^2 + 2x + 2h - 3 - x^2 - 2x + 3 \\
 &= 2xh + h^2 + 2h, \\
 \frac{f(x + h) - f(x)}{h} &= \frac{2xh + h^2 + 2h}{h} \\
 &= \frac{h \cdot (2x + h + 2)}{h} = 2x + h + 2,
 \end{aligned}$$

and

$$\begin{aligned}
 \frac{f(x) - f(a)}{x - a} &= \frac{(x^2 + 2x - 3) - (a^2 + 2a - 3)}{x - a} \\
 &= \frac{x^2 + 2x - 3 - a^2 - 2a + 3}{x - a} = \frac{x^2 - a^2 + 2x - 2a}{x - a} \\
 &= \frac{(x + a)(x - a) + 2(x - a)}{x - a} = \frac{(x - a)(x + a + 2)}{(x - a)} = x + a + 2.
 \end{aligned}$$

□

The quotients $\frac{f(x+h)-f(x)}{h}$ and $\frac{f(x)-f(a)}{x-a}$ as in the last two examples 3.2(k) and (l) will become particularly important in calculus. They are called **difference quotients**. We now calculate some more examples of difference quotients.

Example 3.3. Calculate the difference quotient $\frac{f(x+h)-f(x)}{h}$ for

$$\text{a) } f(x) = x^3 + 2, \quad \text{b) } f(x) = \frac{1}{x}.$$

Solution. We calculate first the difference quotient step by step.

$$\begin{aligned} \text{a) } f(x+h) &= (x+h)^3 + 2 = (x+h) \cdot (x+h) \cdot (x+h) + 2 \\ &= (x^2 + 2xh + h^2) \cdot (x+h) + 2 \\ &= x^3 + 2x^2h + xh^2 + x^2h + 2xh^2 + h^3 + 2, \\ &= x^3 + 3x^2h + 3xh^2 + h^3 + 2. \end{aligned}$$

Subtracting $f(x)$ from $f(x+h)$ gives

$$\begin{aligned} f(x+h) - f(x) &= (x^3 + 3x^2h + 3xh^2 + h^3 + 2) - (x^3 + 2) \\ &= x^3 + 3x^2h + 3xh^2 + h^3 + 2 - x^3 - 2 \\ &= 3x^2h + 3xh^2 + h^3. \end{aligned}$$

With this we obtain:

$$\begin{aligned} \frac{f(x+h) - f(x)}{h} &= \frac{3x^2h + 3xh^2 + h^3}{h} \\ &= \frac{h \cdot (3x^2 + 3xh + h^2)}{h} = 3x^2 + 3xh + h^2. \end{aligned}$$

We handle part (b) similarly.

$$\text{b) } f(x+h) = \frac{1}{x+h},$$

so that

$$f(x+h) - f(x) = \frac{1}{x+h} - \frac{1}{x}.$$

We obtain the solution after simplifying the double fraction:

$$\begin{aligned} \frac{f(x+h) - f(x)}{h} &= \frac{\frac{1}{x+h} - \frac{1}{x}}{h} = \frac{\frac{x-(x+h)}{(x+h) \cdot x}}{h} = \frac{\frac{x-x-h}{(x+h) \cdot x}}{h} = \frac{\frac{-h}{(x+h) \cdot x}}{h} \\ &= \frac{-h}{(x+h) \cdot x} \cdot \frac{1}{h} = \frac{-1}{(x+h) \cdot x}. \end{aligned}$$

□

So far, we have not mentioned the domain and range of the functions defined above. Indeed, we will often not describe the domain explicitly but use the following convention:

Convention 3.4. Unless otherwise stated, a function f has the largest possible domain, that is the domain is the set of all real numbers x for which $f(x)$ is a well-defined real number. We refer to this as the **standard convention of the domain**. (In particular, under this convention, any polynomial has the domain \mathbb{R} of all real numbers.)

The range is the set of all outputs obtained by f from the inputs (see also the warning on page 23.)

Example 3.5. Find the domain of each of the following functions.

$$\begin{array}{ll} \text{a) } f(x) = 4x^3 - 2x + 5, & \text{b) } f(x) = |x|, \\ \text{c) } f(x) = \sqrt{x}, & \text{d) } f(x) = \sqrt{x-3}, \\ \text{e) } f(x) = \frac{1}{x}, & \text{f) } f(x) = \frac{x-2}{x^2+8x+15}, \\ \text{g) } f(x) = \begin{cases} x+1 & , \text{ for } 2 < x \leq 4 \\ 2x-1 & , \text{ for } 5 \leq x \end{cases} \end{array}$$

Solution.

- a) There is no problem taking a real number x to any (positive) power. Therefore, f is defined for all real numbers x , and the domain is written as $D = \mathbb{R}$.
- b) Again, we can take the absolute value for any real number x . The domain is all real numbers, $D = \mathbb{R}$.
- c) The square root \sqrt{x} is only defined for $x \geq 0$ (remember we are not using complex numbers yet!). Thus, the domain is $D = [0, \infty)$.
- d) Again, the square root is only defined for non-negative numbers. Thus, the argument in the square root has to be greater or equal to zero: $x - 3 \geq 0$. Solving this for x gives

$$x - 3 \geq 0 \quad \xrightarrow{\text{(add 3)}} \quad x \geq 3.$$

The domain is therefore, $D = [3, \infty)$.

- e) A fraction is defined whenever the denominator is not zero, so that in this case $\frac{1}{x}$ is defined whenever $x \neq 0$. Therefore the domain is all real numbers except zero, $D = \mathbb{R} - \{0\}$.

- f) Again, we need to make sure that the denominator does not become zero; however we do not care about the numerator. The denominator is zero exactly when $x^2 + 8x + 15 = 0$. Solving this for x gives:

$$\begin{aligned} x^2 + 8x + 15 = 0 &\implies (x + 3) \cdot (x + 5) = 0 \\ &\implies x + 3 = 0 \text{ or } x + 5 = 0 \\ &\implies x = -3 \text{ or } x = -5. \end{aligned}$$

The domain is all real numbers except for -3 and -5 , that is $D = \mathbb{R} - \{-5, -3\}$.

- g) The function is explicitly defined for all $2 < x \leq 4$ and $5 \leq x$. Therefore, the domain is $D = (2, 4] \cup [5, \infty)$.

□

3.2 Functions given by graphs

In many situations, a function is represented by its graph. The graph of a function f is the set of all points (on the coordinate plane) of the form $(x, f(x))$, where x is in the domain of f . We have already seen an example of graphing a function when we discussed lines and their graphs. Here is another example that shows how the formulaic definition relates to the graph of the function.

Example 3.6. Let $y = x^2$ with domain $D = \mathbb{R}$ being the set of all real numbers. We can graph this after calculating a table as follows:

x	-3	-2	-1	0	1	2	3
y	9	4	1	0	1	4	9

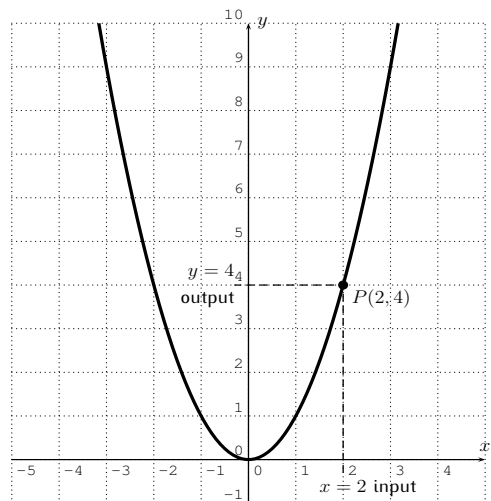

Many function values can be read from this graph. For example, for the input $x = 2$, we obtain the output $y = 4$. This corresponds to the point $P(2, 4)$ on the graph as depicted above.

In general, an input (placed on the x -axis) gets assigned to an output (placed on the y -axis) according to where the vertical line at x intersects with the given graph. This is used in the next example.

Example 3.7. Let f be the function given by the following graph.

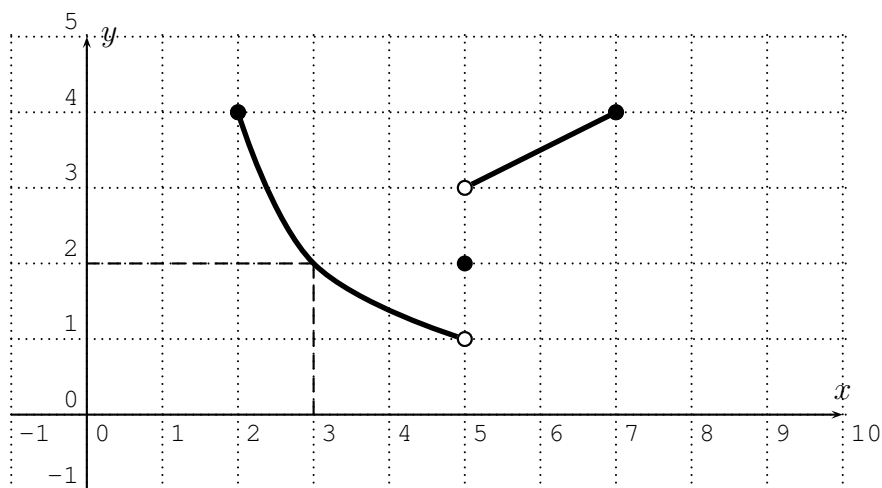

Here, the dashed lines show, that the input $x = 3$ gives an output of $y = 2$. Similarly, we can obtain other output values from the graph:

$$f(2) = 4, \quad f(3) = 2, \quad f(5) = 2, \quad f(7) = 4.$$

Note, that in the above graph, a closed point means that the point is part of the graph, whereas an open point means that it is not part of the graph.

The domain is the set of all possible input values on the x -axis. Since we can take any number $2 \leq x \leq 7$ as an input, the domain is the interval $D = [2, 7]$. The range is the set of all possible output values on the y -axis. Since any number $1 < y \leq 4$ is obtained as an output, the range is $R = (1, 4]$. Note in particular, that $y = 1$ is *not* an output, since $f(5) = 2$.

Example 3.8. Let f be the function given by the following graph.

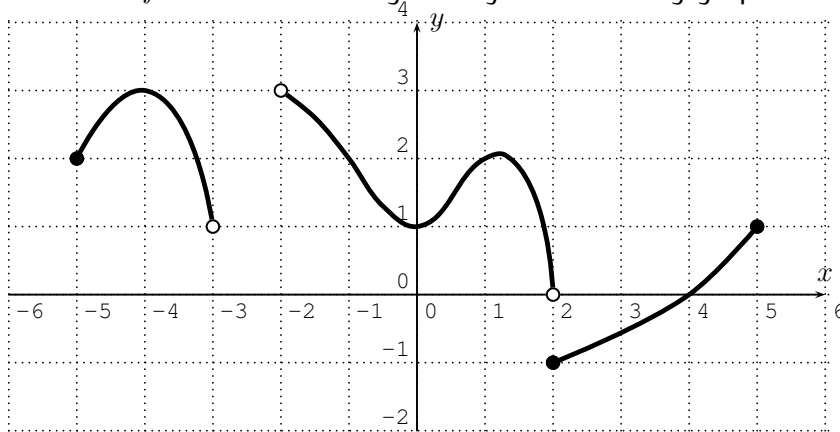

Here are some function values that can be read from the graph:

$$f(-5) = 2, \quad f(-4) = 3, \quad f(-3) \text{ and } f(-2) \text{ are undefined,}$$

$$f(-1) = 2, \quad f(0) = 1, \quad f(1) = 2, \quad f(2) = -1, \quad f(4) = 0, \quad f(5) = 1.$$

Note, that the output value $f(3)$ is somewhere between -1 and 0 , but we can only read off an approximation of $f(3)$ from the graph.

To find the domain of the function, we need to determine all possible x -coordinates (or in other words, we need to project the graph onto the x -axis). The possible x -coordinates are from the interval $[-5, -3)$ together with the intervals $(-2, 2)$ and $[2, 5]$. The last two intervals may be combined. We get the domain:

$$D = [-5, -3) \cup (-2, 5].$$

For the range, we look at all possible y -values. These are given by the intervals $(1, 3]$ and $(0, 3)$ and $[-1, 1]$. Combining these three intervals, we obtain the range

$$R = [-1, 3].$$

Example 3.9. Consider the following graph.

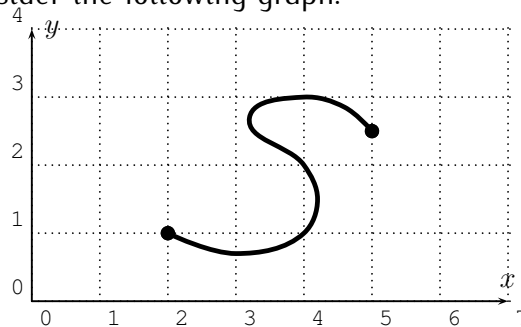

Consider the input $x = 4$. There are several outputs that we get for $x = 4$ from this graph:

$$f(4) = 1, \quad f(4) = 2, \quad f(4) = 3.$$

However, in a function, it is not allowed to obtain more than one output for one input! Therefore, this graph is *not* the graph of a function!

The reason why the previous example is not a function is due to some input having more than one output: $f(4) = 1, f(4) = 2, f(4) = 3$.

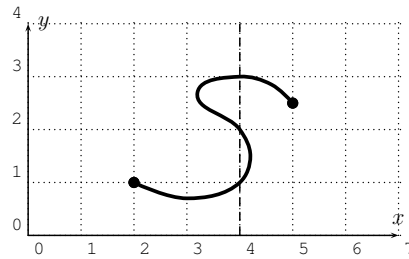

In other words, there is a vertical line ($x = 4$) which intersects the graph in more than one point. This observation is generalized in the following vertical line test.

Observation 3.10 (Vertical Line Test). A graph is the graph of a function precisely when every vertical line intersects the graph at most once.

Example 3.11. Consider the graph of the equation $x = y^2$:

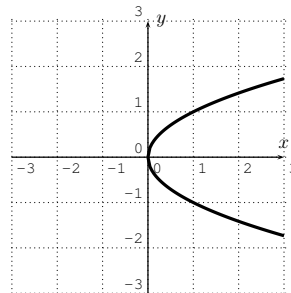

This does not pass the vertical line test so y is not a function of x . However, x is a function of y since, if you consider y to be the input, each input has exactly one output (it passes the 'horizontal line' test).

Example 3.12. Let f be the function given by the following graph.

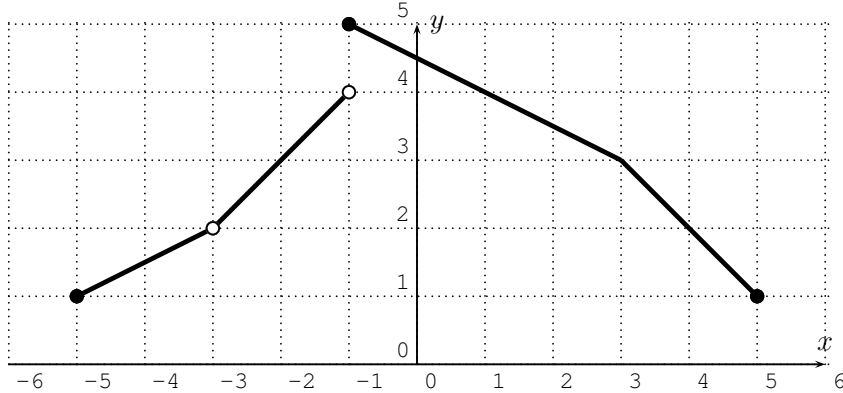

- a) What is the domain of f ? b) What is the range of f ?
 c) For which x is $f(x) = 3$? d) For which x is $f(x) = 2$?
 e) For which x is $f(x) > 2$? f) For which x is $f(x) \leq 4$?
 g) Find $f(1)$ and $f(4)$. h) Find $f(1) + f(4)$.
 i) Find $f(1) + 4$. j) Find $f(1 + 4)$.

Solution. Most of the answers can be read immediately from the graph.

- (a) For the domain, we project the graph to the x -axis. The domain consists of all numbers from -5 to 5 without -3 , that is $D = [-5, -3) \cup (-3, 5]$.
 (b) For the range, we project the graph to the y -axis. The domain consists of all numbers from 1 to 5 , that is $R = [1, 5]$.
 (c) To find x with $f(x) = 3$ we look at the horizontal line at $y = 3$:

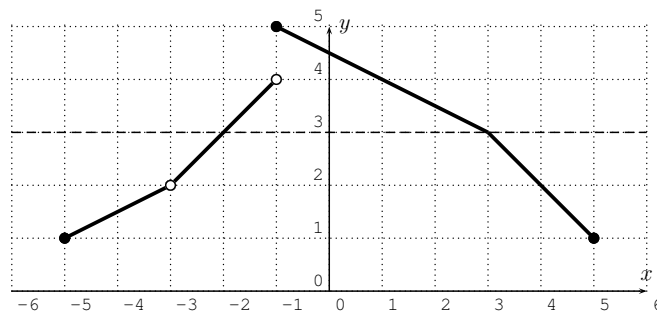

We see that there are two numbers x with $f(x) = 3$:

$$f(-2) = 3, \quad f(3) = 3.$$

Therefore, the answer is $x = -2$ or $x = 3$.

- (d) Looking at the horizontal line $y = 2$, we see that there is only one x with $f(x) = 2$; namely $f(4) = 2$. Note, that $x = -3$ does not solve the problem, since $f(-3)$ is undefined. The answer is $x = 4$.
- (e) To find x with $f(x) > 2$, the graph has to lie above the line $y = 2$.

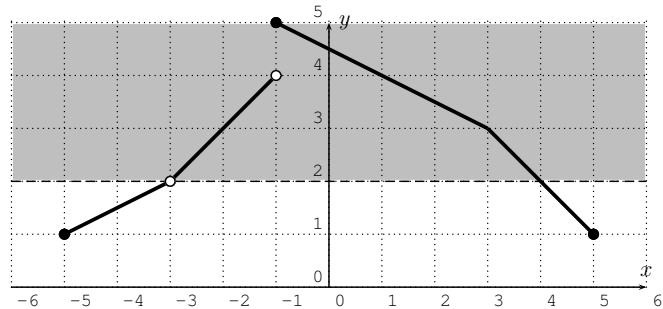

We see that the answer is those numbers x greater than -3 and less than 4 . The answer is therefore the interval $(-3, 4)$.

- (f) For $f(x) \leq 4$, we obtain all numbers x from the domain that are less than -1 or greater or equal to 1 . The answer is therefore,

$$[-5, -3) \cup (-3, -1) \cup [1, 5].$$

Note that -3 is not part of the answer, since $f(-3)$ is undefined.

- (g) $f(1) = 4$, and $f(4) = 2$
- (h) $f(1) + f(4) = 4 + 2 = 6$
- (i) $f(1) + 4 = 4 + 4 = 8$
- (j) $f(1 + 4) = f(5) = 1$

□

Example 3.13. The following graph shows the population size in a small city

in the years 2001–2011 in thousands of people.

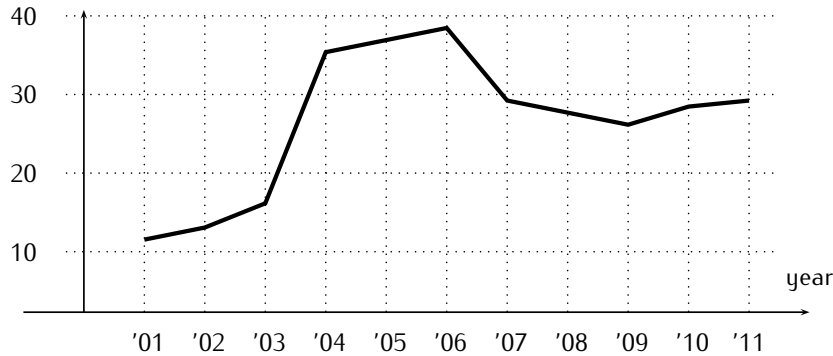

- What was the population size in the years 2004 and 2009?
- In what years did the city have the most population?
- In what year did the population grow the fastest?
- In what year did the population decline the fastest?

Solution. The population size in the year 2004 was approximately 36,000. In the year 2009, it was approximately 26,000. The largest population was in the year 2006, where the graph has its maximum. The fastest growth in the population was between the years 2003 and 2004. That is when the graph has the largest slope. Finally, the fastest decline happened in the years 2006–2007. □

Example 3.14. Graph the function described by the following formula:

$$f(x) = \begin{cases} x + 3 & , \text{ for } -3 \leq x < -1 \\ x^2 & , \text{ for } -1 < x < 1 \\ 3 & , \text{ for } 2 < x \leq 3 \end{cases}$$

Solution. We really have to graph all three functions $y = x + 3$, $y = x^2$, and $y = 3$, and then restrict them to their respective domain. Graphing the three functions, we obtain the following tables and associated graphs, which we draw in one x - y -plane:

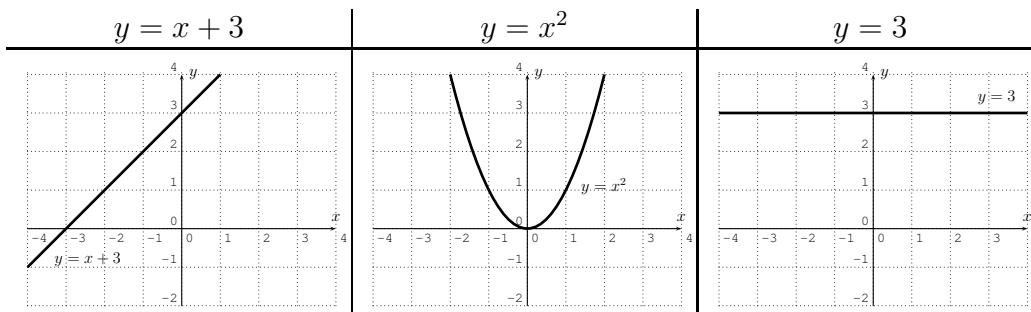

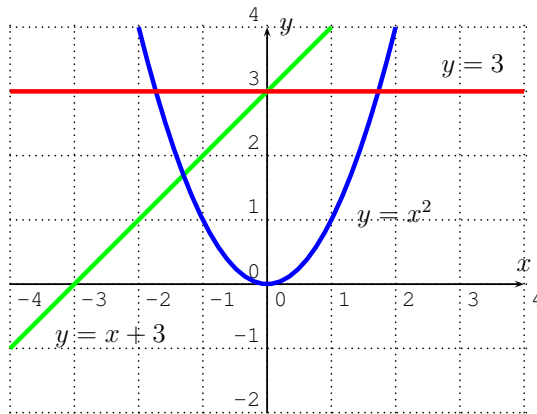

However, we need to cut off the functions according to their specific input domain that is given by the original function.

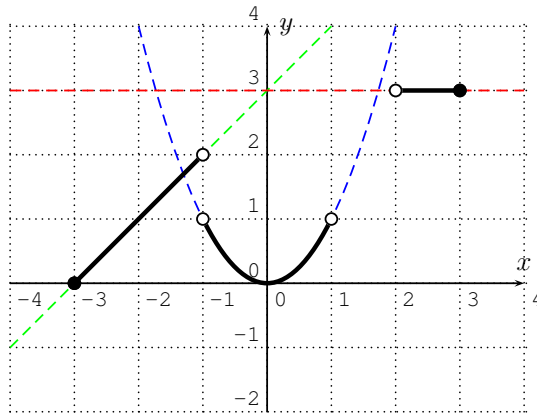

Note, how the open and closed circles at the endpoints of each branch correspond to the “<” and “≤” rules in the original description of the function. □

3.3 Exercises

Exercise 3.1. For each of the following functions,

$$\begin{array}{lll} \text{a) } f(x) = 3x + 1, & \text{b) } f(x) = x^2 - x, & \text{c) } f(x) = \sqrt{x^2 - 9} \\ \text{d) } f(x) = \frac{1}{x}, & \text{e) } f(x) = \frac{x-5}{x+2}, & \text{f) } f(x) = -x^3 \end{array}$$

calculate the function values

$$\begin{array}{lllll} \text{i) } f(3) & \text{ii) } f(5) & \text{iii) } f(-2) & \text{iv) } f(0) & \text{v) } f(\sqrt{13}) \\ \text{vi) } f(\sqrt{2} + 3) & \text{vii) } f(-x) & \text{viii) } f(x + 2) & \text{ix) } f(x) + h & \text{x) } f(x + h) \end{array}$$

Exercise 3.2. Let f be the piecewise defined function

$$f(x) = \begin{cases} x - 5 & , \text{ for } -4 < x < 3 \\ x^2 & , \text{ for } 3 \leq x \leq 6 \end{cases}$$

a) State the domain of the function.

Find the function values

b) $f(2)$, c) $f(5)$, d) $f(-3)$, e) $f(3)$

Exercise 3.3. Let f be the piecewise defined function

$$f(x) = \begin{cases} |x| - x^2 & , \text{ for } x < 2 \\ 7 & , \text{ for } 2 \leq x < 5 \\ x^2 - 4x + 1 & , \text{ for } 5 < x \end{cases}$$

a) State the domain of the function.

Find the function values

b) $f(1)$, c) $f(-2)$, d) $f(3)$,
e) $f(2)$, f) $f(5)$, g) $f(7)$.

Exercise 3.4. Find the difference quotient $\frac{f(x+h)-f(x)}{h}$ for the following functions:

a) $f(x) = 5x$, b) $f(x) = 2x - 6$, c) $f(x) = x^2$,
d) $f(x) = x^2 + 5x$, e) $f(x) = x^2 + 3x + 4$, f) $f(x) = 3 - x^2$,
g) $f(x) = x^2 + 4x - 9$, h) $f(x) = 3x^2 - 2x + 7$, i) $f(x) = x^3$

Exercise 3.5. Find the difference quotient $\frac{f(x)-f(a)}{x-a}$ for the following functions:

a) $f(x) = 3x$, b) $f(x) = 4x - 7$, c) $f(x) = x^2 - 3x$ d) $f(x) = \frac{1}{x}$

Exercise 3.6. Find the domains of the following functions.

a) $f(x) = x^2 + 3x + 5$, b) $f(x) = |x - 2|$, c) $f(x) = \sqrt{x - 2}$
d) $f(x) = \sqrt{8 - 2x}$, e) $f(x) = \sqrt{|x + 3|}$, f) $f(x) = \frac{1}{x+6}$
g) $f(x) = \frac{x-5}{x-7}$, h) $f(x) = \frac{x+1}{x^2-7x+10}$, i) $f(x) = \frac{x}{|x-2|}$
j) $f(x) = \begin{cases} |x| & \text{for } 1 < x < 2 \\ 2x & \text{for } 3 \leq x \end{cases}$, k) $f(x) = \frac{\sqrt{x}}{x-9}$, l) $f(x) = \frac{5}{\sqrt{x+4}}$

Exercise 3.7. Below are three graphs for the functions f , g , and h .

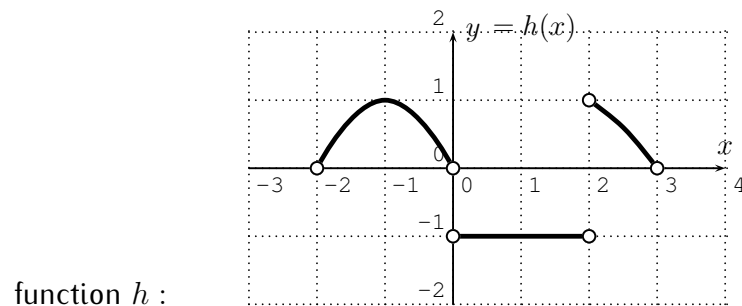
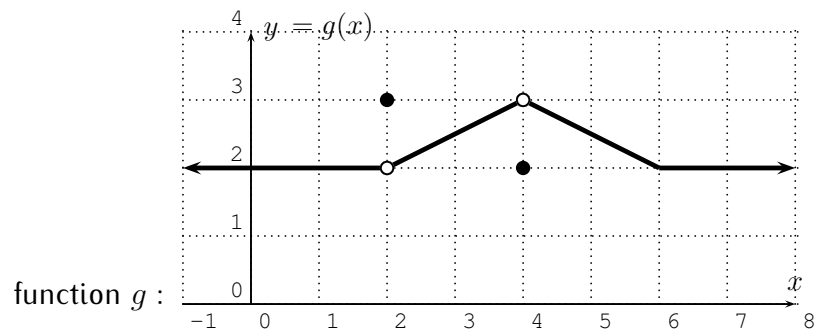
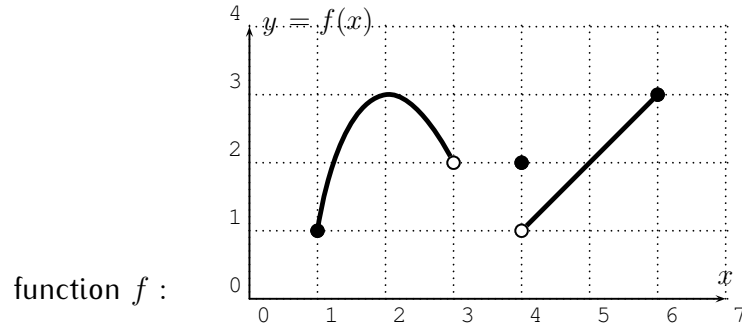

- Find the domain and range of f .
- Find the domain and range of g .
- Find the domain and range of h .

Find the following function values:

- | | | | | | | |
|------------|------------|-----------|-----------|-----------|-----------|------------------|
| d) $f(1)$ | e) $f(2)$ | f) $f(3)$ | g) $f(4)$ | h) $f(5)$ | i) $f(6)$ | j) $f(7)$ |
| k) $g(0)$ | l) $g(1)$ | m) $g(2)$ | n) $g(3)$ | o) $g(4)$ | p) $g(6)$ | q) $g(13.2)$ |
| r) $h(-2)$ | s) $h(-1)$ | t) $h(0)$ | u) $h(1)$ | v) $h(2)$ | w) $h(3)$ | x) $h(\sqrt{2})$ |

Exercise 3.8. Use the vertical line test to determine which of the following graphs are the graphs of functions?

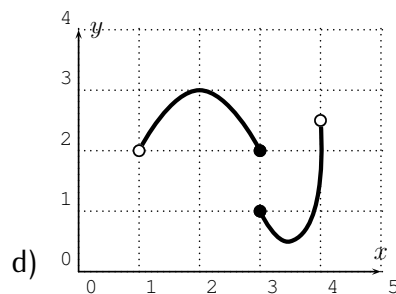
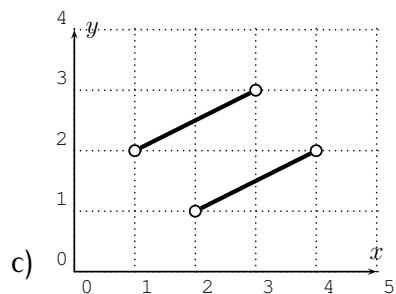
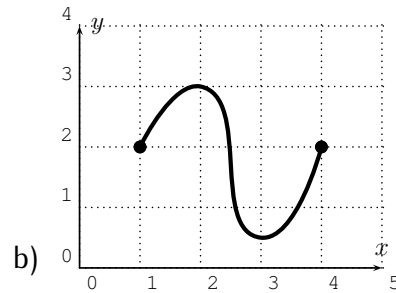
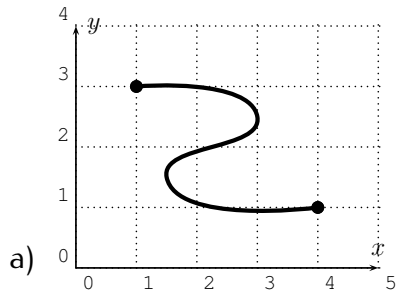

Exercise 3.9. Let f be the function given by the following graph.

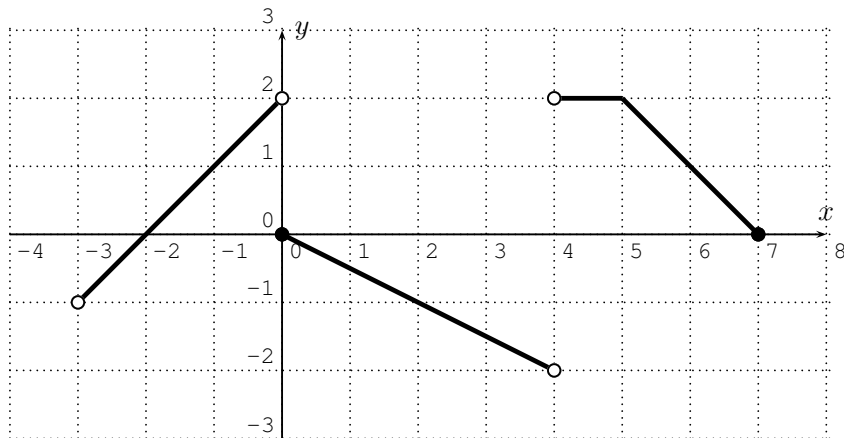

- | | |
|-------------------------------------|----------------------------------|
| a) What is the domain of f ? | b) What is the range of f ? |
| c) For which x is $f(x) = 0$? | d) For which x is $f(x) = 2$? |
| e) For which x is $f(x) \leq 1$? | f) For which x is $f(x) > 0$? |
| g) Find $f(2)$ and $f(5)$. | h) Find $f(2) + f(5)$. |
| i) Find $f(2) + 5$. | j) Find $f(2 + 5)$. |

Exercise 3.10. The graph below displays the number of students admitted to a college during the years 1995 to 2007.

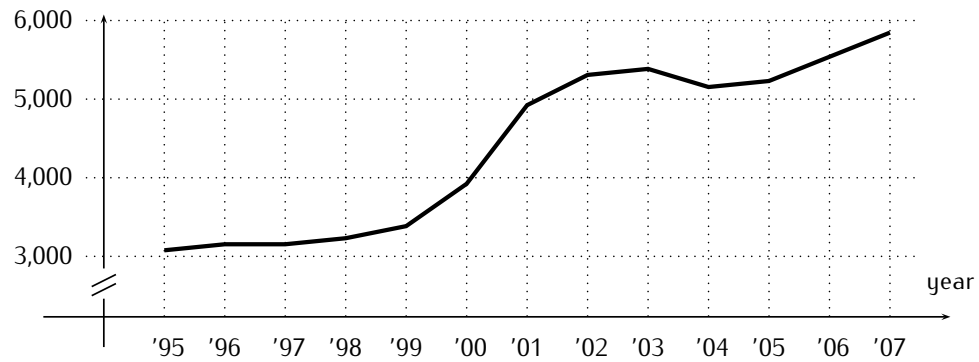

- How many students were admitted in the year 2000?
- In what years were the most students admitted?
- In what years did the number of admitted students rise fastest?
- In what year(s) did the number of admitted students decline?

Exercise 3.11. Consider the function described by the following formula:

$$f(x) = \begin{cases} x^2 + 1 & , \text{ for } -2 < x \leq 0 \\ x - 1 & , \text{ for } 0 < x \leq 2 \\ -x + 4 & , \text{ for } 2 < x \leq 5 \end{cases}$$

What is the domain of the function f ? Graph the function f .

Session 4

Introduction to the TI-84

4.1 Graphing with the TI-84

We now use the TI-84 to graph functions such as the functions discussed in the previous chapters. We start by graphing the very well-known function $y = x^2$, which is of course a parabola. To graph $y = x^2$, we first have to enter the function. Press the $y=$ key to get to the function menu:

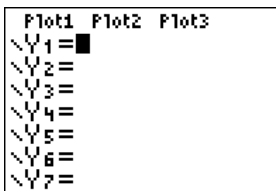

In the first line, enter the function $y = x^2$ by pressing the buttons X, T, θ, n for the variable " x ," and then press the x^2 button. We obtain

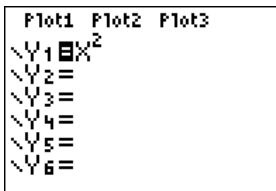

We now go to the graphing window by pressing the key. We obtain:

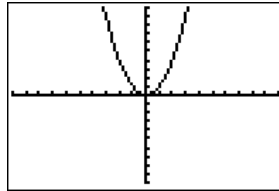

Here, the viewing window is displayed in its initial and *standard* setting between -10 and 10 on the x -axis, and between -10 and 10 on the y -axis. These settings may be changed by pressing the or the keys. First, pressing , we may change the scale by setting X_{min} , X_{max} , Y_{min} and Y_{max} to some new values using and :

```

WINDOW
Xmin=-5
Xmax=3
Xscl=1
Ymin=-4
Ymax=6
Yscl=1
↓Xres=1

```

Note, that negative numbers have to be entered via and not using .

Note 4.1. The difference between and is that is used to denote *negative numbers* (such as -10), whereas is used to *subtract* two numbers (such as $7 - 3$).

Note 4.2. A source for a common error occurs when the "Plot1" item in the function menu is highlighted. When graphing a function as above, always make sure that none of the "plots" are highlighted.

```

Plot1 Plot2 Plot3
Y1=X^2
Y2=
Y3=
Y4=
Y5=
Y6=

```

```

Plot1 Plot2 Plot3
Y1=X^2
Y2=
Y3=
Y4=
Y5=
Y6=

```

After changing the minimum and maximum x - and y -values of our window, we can see the result after pressing again:

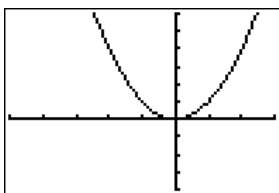

We may zoom in or out or put the setting back to the standard viewing size by pressing the key:

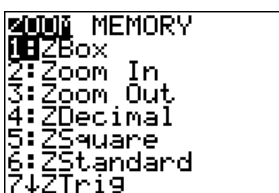

We may zoom in by pressing , then choose a center in the graph where we want to focus (via the , , , keys), and confirm this with :

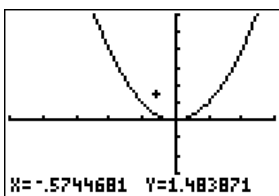

Similarly, we may also zoom out (pressing using in the zoom menu and choosing a center). Finally we can recover the original setting by using ZStandard in the zoom menu (press).

We can graph more than one function in the same window, which we show next.

Example 4.3. Graph the equations $y = \sqrt{7-x}$ and $y = x^3 - 2x^2 - 4$ in the same window.

Solution. Enter the functions as Y1 and Y2 after pressing $\boxed{y=}$. The graphs of both functions appear together in the graphing window:

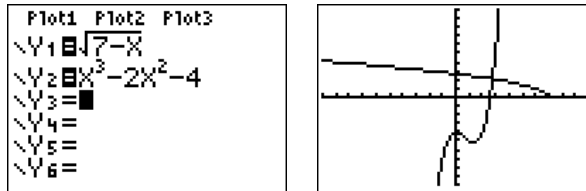

Here, the square root symbol “ $\sqrt{\quad}$ ” is obtained using $\boxed{2nd}$ and $\boxed{x^2}$, and the third power via $\boxed{\wedge}$ and $\boxed{3}$ (followed by $\boxed{\triangleright}$ to continue entering the function on the base line). \square

Example 4.4. Graph the relation $(x - 3)^2 + (y - 5)^2 = 16$.

Solution. Since the above expression is not solved for y , we cannot simply plug this into the calculator. Instead, we have to solve for y first.

$$\begin{aligned} (x - 3)^2 + (y - 5)^2 = 16 &\implies (y - 5)^2 = 16 - (x - 3)^2 \\ &\implies y - 5 = \pm\sqrt{16 - (x - 3)^2} \\ &\implies y = 5 \pm \sqrt{16 - (x - 3)^2} \end{aligned}$$

Note, that there are two functions that we need to graph: $y = 5 + \sqrt{16 - (x - 3)^2}$ and $y = 5 - \sqrt{16 - (x - 3)^2}$. Entering these as Y1 and Y2 in the calculator gives the following function menu and graphing window:

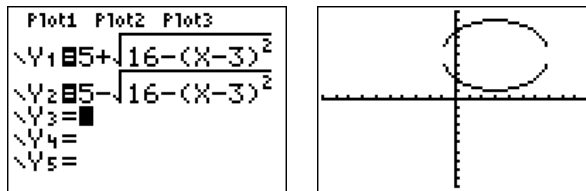

The graph displays a circle of radius 4 with a center at (3, 5). However, due to the current scaling, the graph looks more like an ellipse instead of a circle. We can remedy this by using the “zoom square” function; press \boxed{zoom} $\boxed{5}$. This adjusts the axis to the same scale in the x - and the y -direction.

We obtain the following graph:

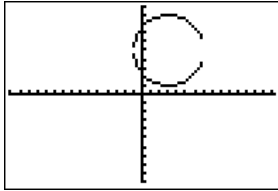

□

Note 4.5. We recall that the equation $(x - h)^2 + (y - k)^2 = r^2$ always forms a circle in the plane. Indeed, this equation describes a circle with center $C(h, k)$ and radius r .

4.2 Finding zeros, maxima, and minima

In this section, we will show how to locate local maxima and minima of a function (peaks and valleys of its graph), and the intersection points of two graphs. Further we will be able to use the calculator to find the x -intercepts of a graph. The x -intercepts are commonly called **zeros** or **roots** of the function f . In other words, a zero of a function f is a number x for which $f(x) = 0$.

Example 4.6. Graph the equation $y = x^3 - 2x^2 - 4x + 4$.

- Find points on the graph via the trace function, and by using the table menu.
- Approximate the zeros of the function via the calculate menu, that is, approximate the x -coordinate(s) of the point(s) where the graph crosses the x -axis.
- Approximate the (local) maximum and minimum via the calculate menu. (A (local) maximum or minimum is also called an **(local) extremum**.)

Solution.

- Graphing the function in the standard window gives the following graph:

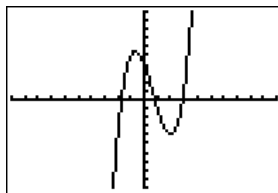

Pressing $\boxed{\text{trace}}$, we can move a cursor to the right and left via $\boxed{\triangleright}$ and $\boxed{\triangleleft}$. We can see several function values as displayed below:

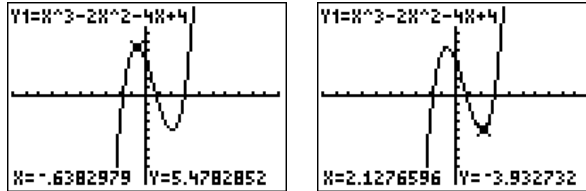

For the graph on the left we have displayed the point $(x, y) \approx (-.638, 5.478)$, and for the graph on the right, we have displayed the point $(x, y) \approx (2.128, -3.933)$.

Another way to find function values is to look at the table menu by pressing $\boxed{2\text{nd}}$ $\boxed{\text{graph}}$:

X	Y1
0	4
1	-1
2	-4
3	1
4	20
5	59
6	124

X=0

We see the y -values for specific x -values are displayed. More values can be displayed by pressing $\boxed{\Delta}$ and $\boxed{\nabla}$. Furthermore, the settings for the table can be changed in the table-set menu by pressing $\boxed{2\text{nd}}$ $\boxed{\text{window}}$. In particular, by changing the the "Indpnt" setting in the table-set menu from "Auto" to "Ask", we can have specific values calculated in the table menu. For example, below, we have calculated the value of y for the independent variable x set to $x = 4$.

X	Y1
4	20

X=

- b) Note, that the function f has three x -intercepts (the places on a graph intersects with the x -axis). They are called the zeros of the function

and can be approximated with the TI-84. We have to find each zero, one at a time. To this end, we need to switch the calculate menu

:

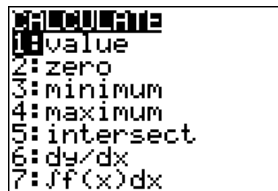

Press to find a zero. We need to specify a left bound (using the keys ,) and , that is a point on the graph that is a bit left of the zero that we seek. Next, we also need to specify a right bound for our zero, and also a “guess” that is close to the zero:

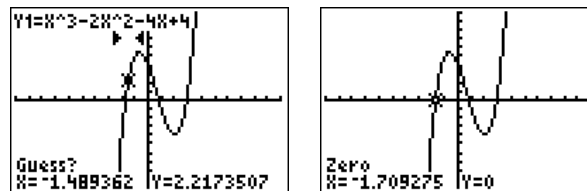

The zero displayed is approximately at $x \approx -1.709$ (rounded to the nearest thousandth).

Similarly, we can also approximate the other zeros using the calculate menu . After choosing lower bounds, upper bounds, and guesses, we obtain:

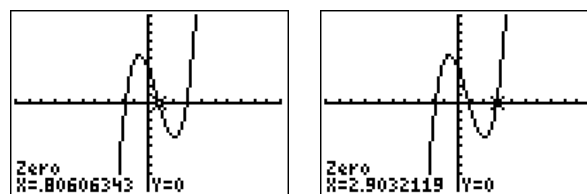

The zeros are approximately at $x \approx 0.806$ and $x \approx 2.903$.

- c) The TI-84 can also approximate the maximum and minimum of the function (the places on a graph where there is a ‘peak’ or a ‘valley’). This

is again done in the calculate menu $\boxed{2\text{nd}} \boxed{\text{trace}}$:

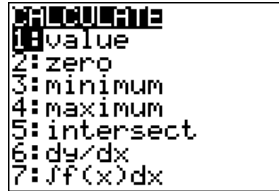

Now, press $\boxed{3}$ for the minimum. After specifying a left bound, a right bound, and a guess, we obtain the following answer for our minimum:

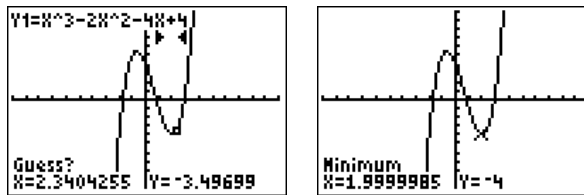

The minimum displayed is at $(1.9999985, -4)$. The actual answer on your calculator may be different, depending on the bounds and the guess chosen. However, it is important to note that the exact minimum is at $(x, y) = (2, -4)$, whereas **the calculator only provides an approximation of the minimum!**

Similarly, we can also approximate the maximum in the calculate menu $\boxed{2\text{nd}} \boxed{\text{trace}} \boxed{4}$. After choosing lower and upper bound, we obtain:

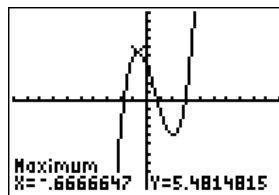

Therefore, the maximum is approximately at $(x, y) \approx (-0.667, 5.481)$, after rounding to the nearest thousandth.

This concludes example 4.6. □

Note 4.7. We can always return to the home screen by pressing quit, that is

$\boxed{2\text{nd}} \boxed{\text{mode}}$.

Example 4.8. Graph the equation $y = x^4 - x^3 - 4x^2 + 4x$.

- Approximate the zeros of the function via the calculate menu.
- Approximate the (local) maxima and the minima via the calculate menu.
- Calculate the zeros of the function via the solve function.

Solution.

- First, press $\boxed{y=}$ and enter the function $y = x^4 - x^3 - 4x^2 + 4x$. We find the zeros using item 2 from the calculate menu. Here are two of the four zeros:

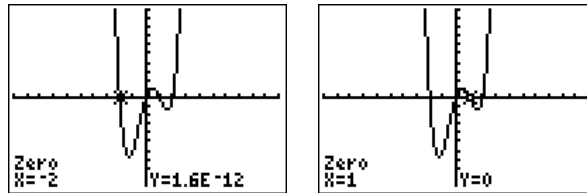

Note, in particular, the left zero has a y value of “1.6E–12,” that is $y = 1.6 \cdot 10^{-12} = 0.00000000000016$. The value $x = -2$ is an actual zero as can be seen by direct computation, whereas the calculator only obtains an approximation!

- From the calculate menu, $\boxed{2nd}$ \boxed{trace} , items 3 and 4 can be used to approximate the maximum and the two minima, (choosing a lower bound, upper bound, and a guess each time):

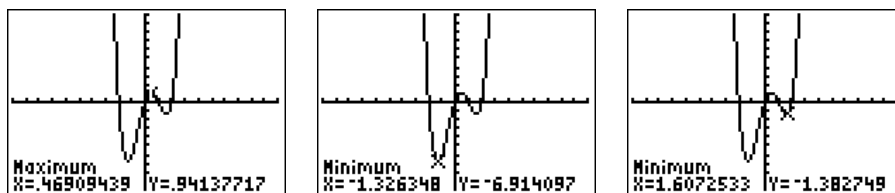

- There is also a non-graphical procedure to calculate the zeros of the function $y = x^4 - x^3 - 4x^2 + 4x$. Algebraically, we want to find a number x so that $y = 0$. In other words:

$$0 = x^4 - x^3 - 4x^2 + 4x.$$

Press the $\boxed{\text{math}}$ button, scroll down to “Solver...” and press the $\boxed{\text{enter}}$ key. You will end up in one of the following two screens:

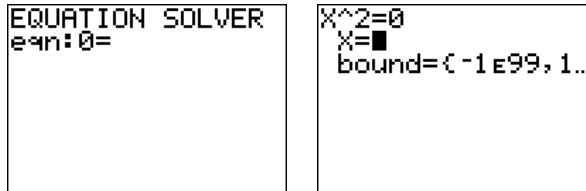

If you obtained the screen on the right, press $\boxed{\Delta}$ to get to the screen on the left. Enter the equation and press $\boxed{\text{enter}}$.

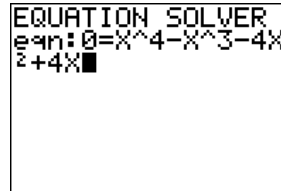

We now need to specify a number X which is our “guess” for the zero. In other words, the calculator will try to identify a zero that is close to a specified number X . For example, we may enter $x = 3$. Then, the solve command is executed by pressing $\boxed{\text{alpha}}$ $\boxed{\text{enter}}$; (the $\boxed{\text{alpha}}$ -key gives access to the commands written in green). We obtain the following zero:

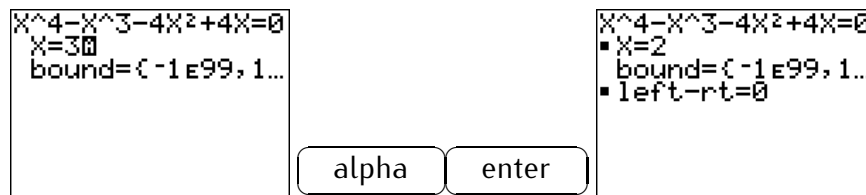

Choosing other values for x (for example $x = 1.2$, $x = 0.2$ and $x = -3$) produces the other three zeros after pressing $\boxed{\text{alpha}}$ $\boxed{\text{enter}}$.

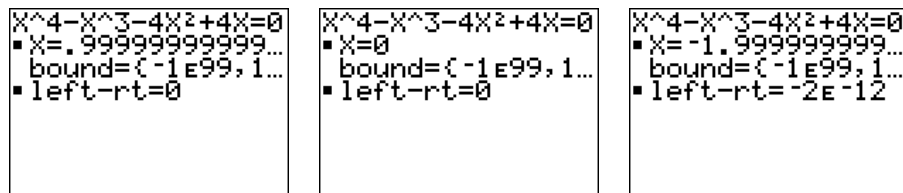

Note, that the exact zeros are $x = 2$, $x = 1$, $x = 0$, and $x = -2$, whereas again the calculator only supplied an approximation!

□

The equation solver used in the last example (part (c)) is a slightly faster method for finding zeros than using the graph and the calculate menu. However, the disadvantage is that we first need to have some knowledge about the zeros (such as how many zeros there are!) before we can effectively use this tool. Generally, the graph and the calculate menu will give us a much better idea of where the zeros are located. For this reason, we recommend to use the calculate menu as the main method of finding zeros.

Example 4.9. Solve the equation. Approximate your answer to the nearest hundredth.

$$\text{a) } x^4 + 3x^2 - 5x - 7 = 0, \quad \text{b) } x^3 - 4 = 7x - 3^x.$$

Solution. a) We need to find all numbers x so that $x^4 + 3x^2 - 5x - 7 = 0$. Note, that these are precisely the zeros of the function $f(x) = x^4 + 3x^2 - 5x - 7$, since the zeros are the values x for which $f(x) = 0$. Graphing the function $f(x) = x^4 + 3x^2 - 5x - 7$ shows that there are two zeros.

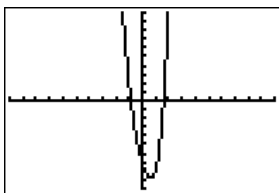

Using the calculate menu, we can identify both zeros.

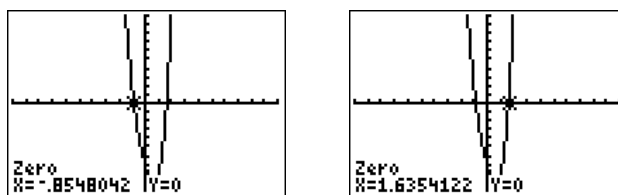

The answer is therefore, $x \approx -0.85$ and $x \approx 1.64$ (rounded to the nearest hundredth).

b) We use the same method as in part (a). To this end we rewrite the equation so that one side becomes zero:

$$x^3 - 4 - 7x + 3^x = 0$$

We can now graph the function $f(x) = x^3 - 4 - 7x + 3^x$ and find its zeros.

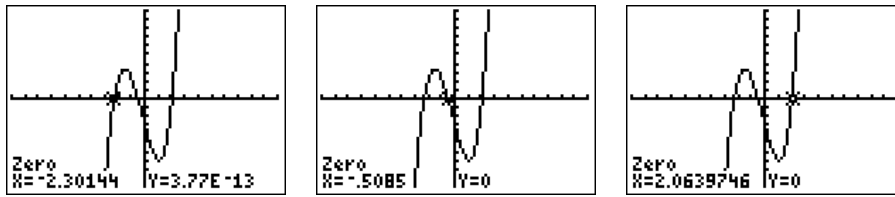

We see that there are three solutions, $x \approx -2.30$, $x \approx -0.51$, and $x \approx 2.06$. \square

By a method similar to the above, we can also find the intersection points of two given graphs.

Example 4.10. Graph the equations $y = x^2 - 3x + 2$ and $y = x^3 + 2x^2 - 1$.

- Approximate the intersection point of the two graphs via the calculate menu.
- Calculate the intersection point of the two graphs via the solve function.

Solution. First, enter the two equations for Y1 and Y2 after pressing the $y=$ key. Both graphs are displayed in the graphing window.

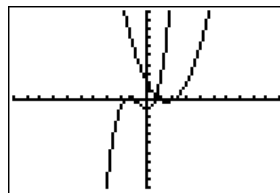

- The procedure for finding the intersection of the graphs for Y1 and Y2 is similar to finding minima, maxima, or zeros. In the calculate menu, 2nd trace , choose intersect (item 5). Choose the first curve Y1 (with Δ , ∇ , and enter), and the second curve Y2. Finally choose a guess of the intersection point (with \leftarrow),

\triangleright), and enter). The intersection is approximated as $(x, y) \approx (.71134574, .37197554)$:

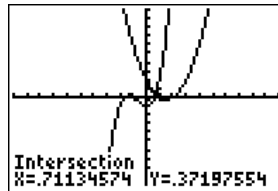

- b) The intersection is the point where the two y -values $y = x^2 - 3x + 2$ and $y = x^3 + 2x^2 - 1$ coincide. Therefore, we want to find an x with

$$x^2 - 3x + 2 = x^3 + 2x^2 - 1$$

The TI-84 equation solver requires an equation with zero on the left. Therefore, we subtract the left-hand side, and obtain:

$$\begin{aligned} (\text{subtract } (x^2 - 3x + 2)) &\implies 0 = (x^3 + 2x^2 - 1) - (x^2 - 3x + 2) \\ &\implies 0 = x^3 + 2x^2 - 1 - x^2 + 3x - 2 \\ &\implies 0 = x^3 + x^2 + 3x - 3 \end{aligned}$$

Entering $0 = x^3 + x^2 + 3x - 3$ into the equation solver, math Δ enter , and choosing an approximation $x = 1$ for X , the calculator solves this equation (using α enter) as follows:

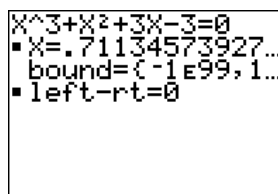

The approximation provided by the calculator is $x \approx .71134573927\dots$

□

4.3 Exercises

Exercise 4.1. Graph the equation in the standard window.

- a) $y = 3x - 5$ b) $y = x^2 - 3x - 2$ c) $y = x^4 - 3x^3 + 2x - 1$
 d) $y = \sqrt{x^2 - 4}$ e) $y = \frac{1}{x+2}$ f) $y = |x + 3|$

For the last exercise, the absolute value is obtained by pressing $\boxed{\text{math}}$
 $\boxed{\triangleright}$ $\boxed{\text{enter}}$.

Exercise 4.2. Solve the equation for y and graph all branches in the same window.

a) $x^2 + y^2 = 4$ b) $(x + 5)^2 + y^2 = 15$ c) $(x - 1)^2 + (y - 2)^2 = 9$
 d) $y^2 + x^2 - 8x - 14 = 0$ e) $y^2 = x^2 + 3$ f) $y^2 = -x^2 + 77$

Exercise 4.3. Find all zeros of the given function. Round your answer to the nearest hundredth.

a) $f(x) = x^2 + 3x + 1$ b) $f(x) = x^4 - 3x^2 + 2$
 c) $f(x) = x^3 + 2x - 6$ d) $f(x) = x^5 - 11x^4 + 20x^3 + 88x^2 - 224x + 1$
 e) $f(x) = x^3 - 5x^2 + 2x + 3$ f) $f(x) = \sqrt{2x - 3} - 2x + 3$
 g) $f(x) = 0.04x^3 - 0.02x^2 - 0.5174x + 0.81$
 h) $f(x) = 0.04x^3 - 0.02x^2 - 0.5175x + 0.81$
 i) $f(x) = 0.04x^3 - 0.02x^2 - 0.5176x + 0.81$

Exercise 4.4. Find all solutions of the equation. Round your answer to the nearest thousandth.

a) $x^3 + 3 = x^5 + 7$ b) $4x^3 + 6x^2 - 3x - 2 = 0$
 c) $\frac{2x}{x-3} = \frac{x^2+2}{x+1}$ d) $5^{3x+1} = x^5 + 6$
 e) $x^3 + x^2 = x^4 - x^2 + x$ f) $3x^2 = x^3 - x^2 + 3x$

Exercise 4.5. Graph the equation. Determine how many maxima and minima the graph has. To this end, resize the graphing window (via the zoom-in, zoom-out, and zoom-box functions of the calculator) to zoom into the maxima or minima of the graph.

a) $y = x^2 - 4x + 13$ b) $y = -x^2 + x - 20$
 c) $y = 2x^3 - 5x^2 + 3x$ d) $y = x^4 - 5x^3 + 8x^2 - 5x + 1$

Exercise 4.6. Approximate the (local) maxima and minima of the graph. Round your answer to the nearest tenth.

a) $y = x^3 + 2x^2 - x + 1$ b) $y = x^3 - 5x^2 + 8x - 3$
 c) $y = -x^4 + 3x^3 + x^2 + 2$ d) $y = x^4 - x^3 - 4x^2 + 6x + 2$
 e) $y = x^4 - x^3 - 4x^2 + 8x + 2$ f) $y = x^4 - x^3 - 4x^2 + 7x + 2$

Session 5

Basic functions and transformations

5.1 Graphing basic functions

It will be useful to study the shape of graphs of some basic functions, which may then be taken as building blocks for more advanced and complicated functions. In this section, we consider the following basic functions:

$$y = |x|, \quad y = x^2, \quad y = x^3, \quad y = \sqrt{x}, \quad y = \frac{1}{x}.$$

We can either graph these functions by hand by calculating a table, or by using the TI-84, via the table and graph buttons.

- We begin with the absolute value function $y = |x|$. Recall that the absolute value is obtained on the calculator in the math menu by pressing . The domain of $y = |x|$ is all real numbers, $D = \mathbb{R}$.

X	Y1	
3	3	
2	2	
1	1	
0	0	
-1	1	
-2	2	
-3	3	

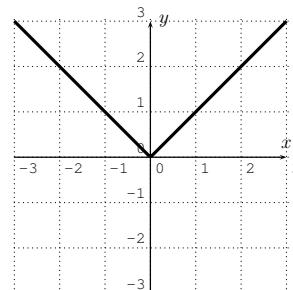
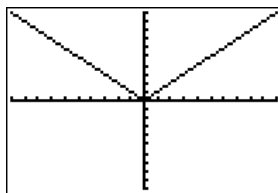

We have drawn the graph a second time in the x - y -plane on the right.

- Similarly, we obtain the graph for $y = x^2$, which is a parabola. The domain is $D = \mathbb{R}$.

X	Y1	
-3	9	
-2	4	
-1	1	
0	0	
1	1	
2	4	
3	9	
X=-3		

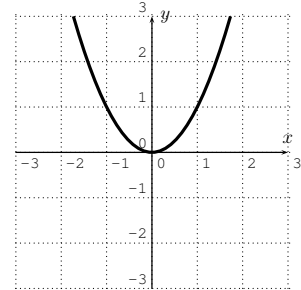
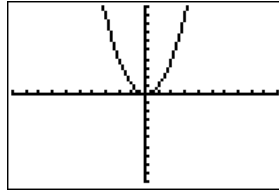

- Here is the graph for $y = x^3$. The domain is $D = \mathbb{R}$.

X	Y1	
-3	-27	
-2	-8	
-1	-1	
0	0	
1	1	
2	8	
3	27	
X=-3		

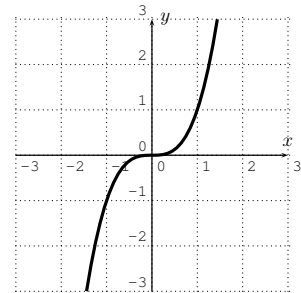
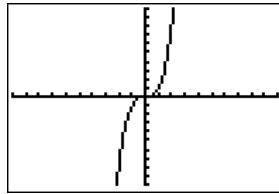

- Next we graph $y = \sqrt{x}$. The domain is $D = [0, \infty)$.

X	Y1	
0	ERROR	
1	1	
2	1.4142	
3	1.7321	
4	2	
5	2.2361	
X=-1		

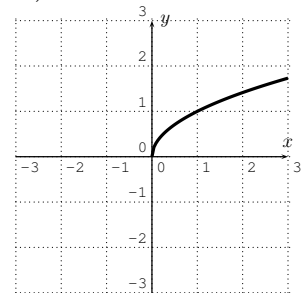
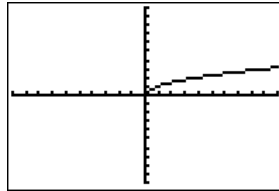

- Finally, here is the graph for $y = \frac{1}{x}$. The domain is $D = \mathbb{R} - \{0\}$.

X	Y1	
-3	-.33333	
-2	-.5	
-1	-1	
0	ERROR	
1	1	
2	.5	
3	.33333	
X=-3		

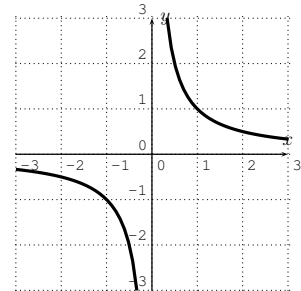
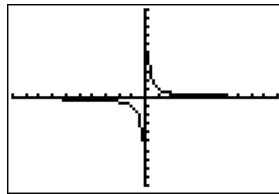

These graphs together with the line $y = mx + b$ studied in Section 2.1 are our basic building blocks for more complicated graphs in the next sections. Note in particular, that the graph of $y = x$ is the diagonal line.

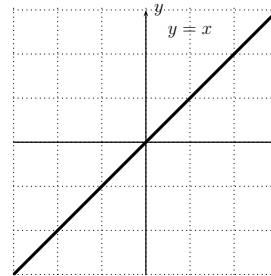
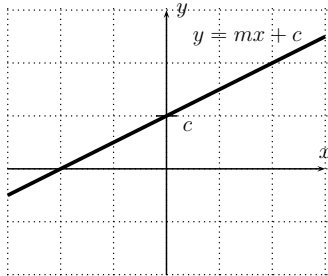

5.2 Transformation of graphs

For a given function, we now study how the graph of the function changes when performing elementary operations, such as adding, subtracting, or multiplying a constant number to the input or output. We will study the behavior in five specific examples.

1. Consider the following graphs:

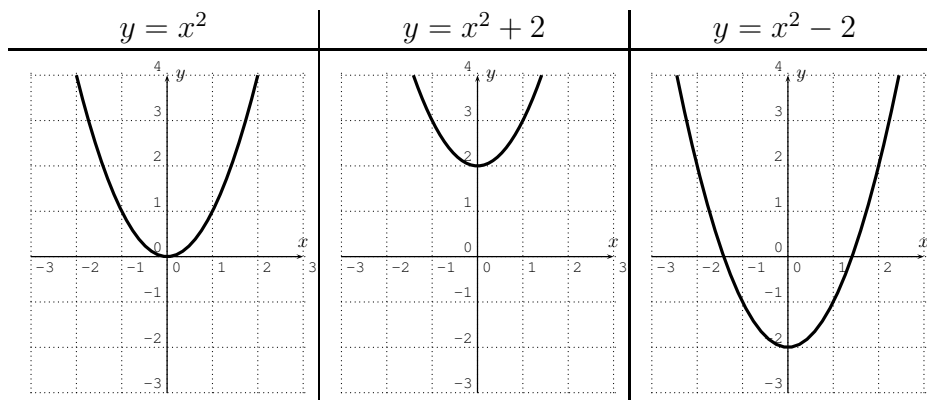

We see that the function $y = x^2$ is shifted up by 2 units, respectively down by 2 units. In general, we have:

Observation 5.1. Consider the graph of a function $y = f(x)$. Then, the graph of $y = f(x) + c$ is that of $y = f(x)$ shifted up or down by c . If c is positive, the graph is shifted up, if c is negative, the graph is shifted down.

2. Next, we consider the transformation of $y = x^2$ given by adding or subtracting a constant to the input x .

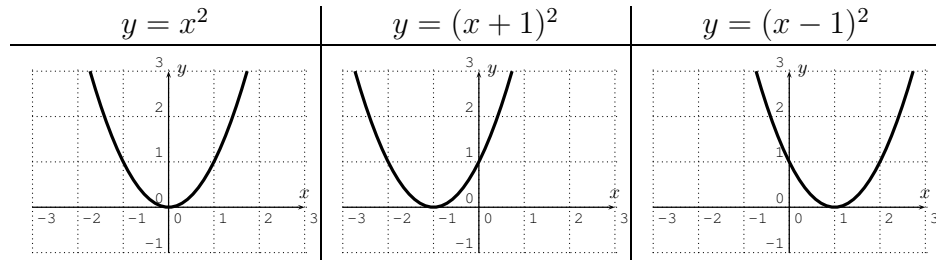

Now, we see that the function is shifted to the left or right. Note, that $y = (x + 1)^2$ shifts the function to the left, which can be seen to be correct, since the input $x = -1$ gives the output $y = ((-1) + 1)^2 = 0^2 = 0$.

Observation 5.2. Consider the graph of a function $y = f(x)$. Then, the graph of $y = f(x + c)$ is that of $y = f(x)$ shifted to the left or right by c . If c is positive, the graph is shifted to the left, if c is negative, the graph is shifted to the right.

3. Another transformation is given by multiplying the function by a fixed positive factor.

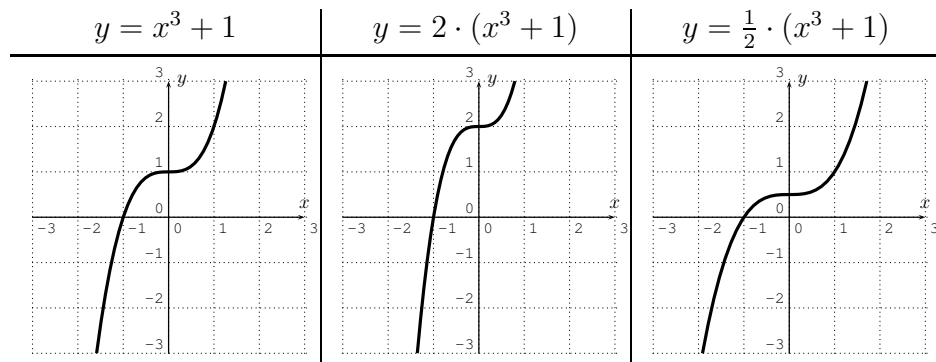

This time, the function is stretched away or compressed towards the x -axis.

Observation 5.3. Consider the graph of a function $y = f(x)$ and let $c > 0$. Then, the graph of $y = c \cdot f(x)$ is that of $y = f(x)$ stretched away or compressed towards the x -axis by a factor c . If $c > 1$, the graph is stretched away from the x -axis, if $0 < c < 1$, the graph is compressed towards the x -axis.

4. Similarly, we can multiply the input by a positive factor.

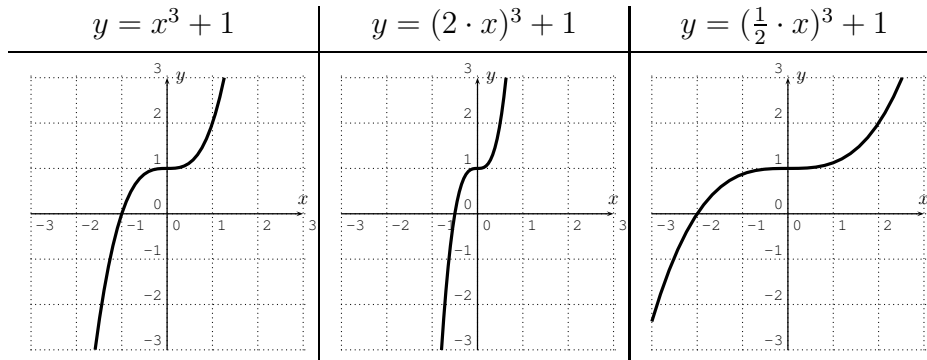

This time, the function is stretched away or compressed towards the y -axis.

Observation 5.4. Consider the graph of a function $y = f(x)$ and let $c > 0$. Then, the graph of $y = f(c \cdot x)$ is that of $y = f(x)$ stretched away or compressed towards the y -axis by a factor c . If $c > 1$, the graph is compressed towards the y -axis, if $0 < c < 1$, the graph is stretched away from the y -axis.

5. The last transformation is given by multiplying (-1) to the input or output, as displayed in the following chart.

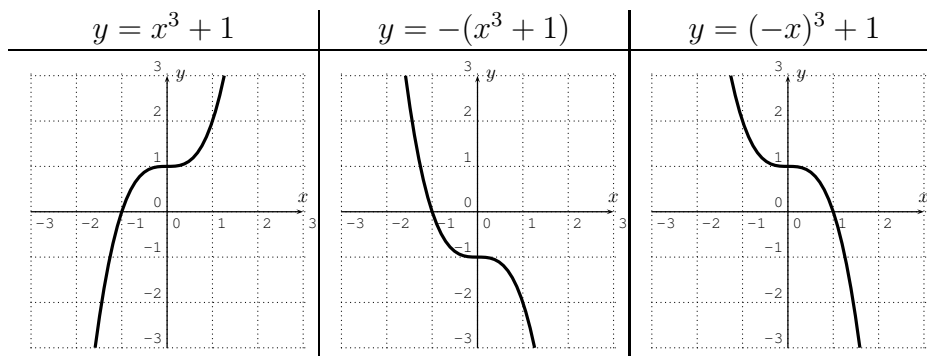

Here, the function is reflected either about the x -axis or the y -axis.

Observation 5.5. Consider the graph of a function $y = f(x)$. Then, the graph of $y = -f(x)$ is that of $y = f(x)$ reflected about the x -axis. Furthermore, the graph of $y = f(-x)$ is that of $y = f(x)$ reflected about the y -axis.

Example 5.6. Guess the formula for the function, based on the basic graphs in Section 5.1 and the transformations described above.

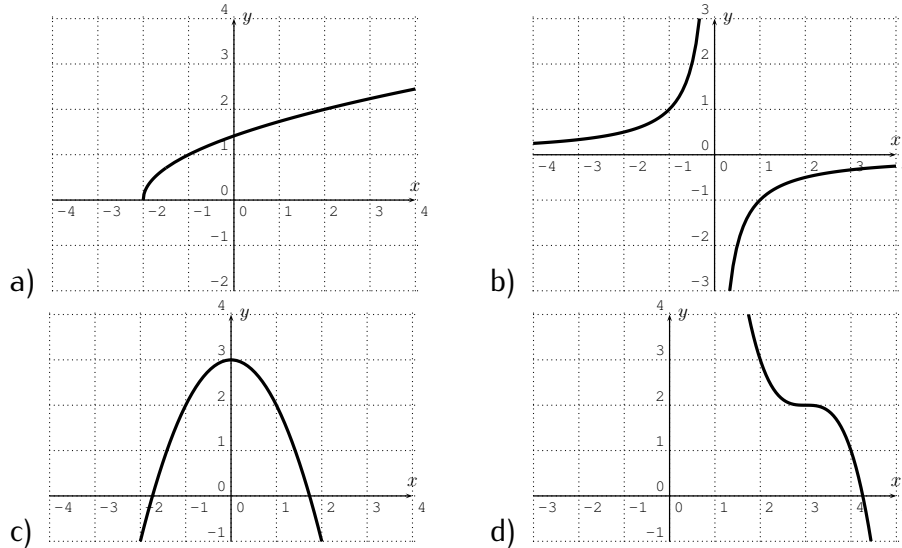

Solution. a) This is the square-root function shifted to the left by 2. Thus, by Observation 5.1, this is the function $f(x) = \sqrt{x+2}$.

b) This is the graph of $y = \frac{1}{x}$ reflected about the x -axis (or also $y = \frac{1}{x}$ reflected about the y -axis). In either case, we obtain the rule $y = -\frac{1}{x}$.

c) This is a parabola reflected about the x -axis and then shifted up by 3. Thus, we get:

$$\begin{aligned}
 & y = x^2 \\
 \text{reflecting about the } x\text{-axis gives} & \quad y = -x^2 \\
 \text{shifting the graph up by 3 gives} & \quad y = -x^2 + 3
 \end{aligned}$$

d) Starting from the graph of the cubic equation $y = x^3$, we need to reflect about the x -axis (or also y -axis), then shift up by 2 and to the right by 3. These transformations affect the formula as follows:

$$\begin{aligned}
 & y = x^3 \\
 \text{reflecting about the } x\text{-axis gives} & \quad y = -x^3 \\
 \text{shifting up by 2 gives} & \quad y = -x^3 + 2 \\
 \text{shifting the the right by 3 gives} & \quad y = -(x-3)^3 + 2
 \end{aligned}$$

All these answers can be checked by graphing the function with the TI-84. □

Example 5.7. Sketch the graph of the function, based on the basic graphs in Section 5.1 and the transformations described above.

$$\begin{array}{lll} \text{a) } y = x^2 + 3 & \text{b) } y = (x + 2)^2 & \text{c) } y = |x - 3| - 2 \\ \text{d) } y = 2 \cdot \sqrt{x + 1} & \text{e) } y = -\left(\frac{1}{x} + 2\right) & \text{f) } y = (-x + 1)^3 \end{array}$$

Solution. a) This is the parabola $y = x^2$ shifted up by 3. The graph is shown below.

b) $y = (x + 2)^2$ is the parabola $y = x^2$ shifted 2 units to the left.

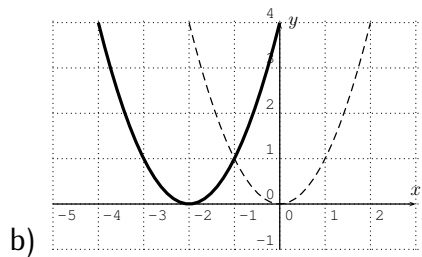
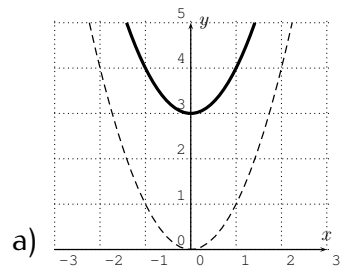

c) The graph of the function $f(x) = |x - 3| - 2$ is the absolute value shifted to the right by 3 and down by 2. (Alternatively, we can first shift down by 2 and then to the right by 3.)

d) Similarly, to get from the graph of $y = \sqrt{x}$ to the graph of $y = \sqrt{x + 1}$, we shift the graph to the left, and then for $y = 2 \cdot \sqrt{x + 1}$, we need to stretch the graph by a factor 2 away from the x -axis. (Alternatively, we could first stretch the the graph away from the x -axis, then shift the graph by 1 to the left.)

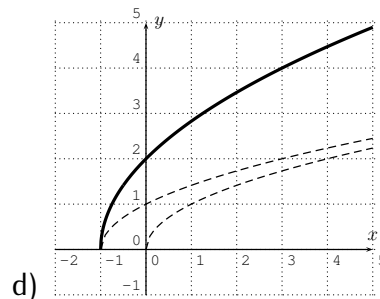
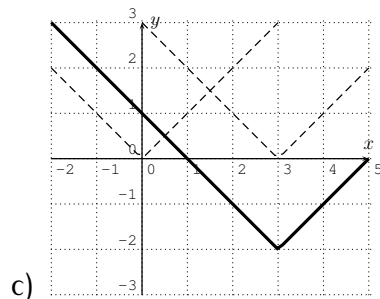

e) For $y = -\left(\frac{1}{x} + 2\right)$, we start with $y = \frac{1}{x}$ and add 2, giving $y = \frac{1}{x} + 2$, which shifts the graph up by 2. Then, taking the negative gives $y = -\left(\frac{1}{x} + 2\right)$, which corresponds to reflecting the graph about the x -axis.

Note, that in this case, we cannot perform these transformations in the opposite order, since the negative of $y = \frac{1}{x}$ gives $y = -\frac{1}{x}$, and adding 2 gives $y = -\frac{1}{x} + 2$ which is *not* equal to $-\left(\frac{1}{x} + 2\right)$.

- f) We start with $y = x^3$. Adding 1 in the argument, $y = (x + 1)^3$, shifts its graph to the left by 1. Then, taking the negative in the argument gives $y = (-x + 1)^3$, which reflects the graph about the y -axis.

Here, the order in which we perform these transformations is again important. In fact, if we first take the negative in the argument, we obtain $y = (-x)^3$. Then, adding one in the argument would give $y = (-x + 1)^3 = (-x - 1)^3$ which is different than our given function $y = (-x + 1)^3$.

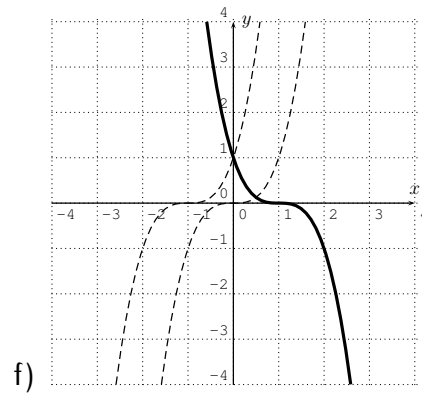
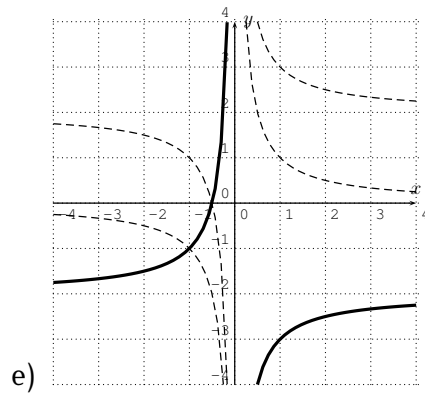

All these solutions may also easily be checked by using the graphing function of the calculator. \square

Example 5.8. a) The graph of $f(x) = |x^3 - 5|$ is stretched away from the y -axis by a factor of 3. What is the formula for the new function?

b) The graph of $f(x) = \sqrt{6x^2 + 3}$ is shifted up 5 units, and then reflected about the x -axis. What is the formula for the new function?

c) How are the graphs of $y = 2x^3 + 5x - 9$ and $y = 2(x - 2)^3 + 5(x - 2) - 9$ related?

d) How are the graphs of $y = (x - 2)^2$ and $y = (-x + 3)^2$ related?

Solution. a) By Observation 5.4 on page 67, we have to multiply the argument by $\frac{1}{3}$. The new function is therefore:

$$f\left(\frac{1}{3} \cdot x\right) = \left|\left(\frac{1}{3} \cdot x\right)^3 - 5\right| = \left|\frac{1}{27} \cdot x^3 - 5\right|$$

- b) After the shift, we have the graph of a new function $y = \sqrt{6x^2 + 3} + 5$. Then, a reflection about the x -axis gives the graph of the function $y = -(\sqrt{6x^2 + 3} + 5)$.
- c) By Observation 5.2 on page 66, we see that we need to shift the graph of $y = 2x^3 + 5x - 9$ by 2 units to the right.
- d) The formulas can be transformed into each other as follows:

$$\begin{aligned} \text{We begin with} & & y &= (x - 2)^2. \\ \text{Replacing } x \text{ by } x + 5 \text{ gives} & & y &= ((x + 5) - 2)^2 = (x + 3)^2. \\ \text{Replacing } x \text{ by } -x \text{ gives} & & y &= ((-x) + 3)^2 = (-x + 3)^2. \end{aligned}$$

Therefore, we have performed a shift to the left by 5, and then a reflection about the y -axis.

We want to point out that there is a second solution for this problem:

$$\begin{aligned} \text{We begin with} & & y &= (x - 2)^2. \\ \text{Replacing } x \text{ by } -x \text{ gives} & & y &= ((-x) - 2)^2 = (-x - 2)^2. \\ \text{Replacing } x \text{ by } x - 5 \text{ gives} & & y &= (-(x - 5) - 2)^2 = (-x + 5 - 2)^2 = (-x + 3)^2. \end{aligned}$$

Therefore, we could also first perform a reflection about the y -axis, and then shift the graph to the right by 5. □

Some of the above functions have special symmetries, which we investigate now.

Definition 5.9. A function f is called **even** if $f(-x) = f(x)$ for all x .

Similarly, a function f is called **odd** if $f(-x) = -f(x)$ for all x .

Example 5.10. Determine, if the following functions are even, odd, or neither.

$$\begin{aligned} f(x) &= x^2, & g(x) &= x^3, & h(x) &= x^4, & k(x) &= x^5, \\ l(x) &= 4x^5 + 7x^3 - 2x, & m(x) &= x^2 + 5x. \end{aligned}$$

Solution. The function $f(x) = x^2$ is even, since $f(-x) = (-x)^2 = x^2$. Similarly, $g(x) = x^3$ is odd, $h(x) = x^4$ is even, and $k(x) = x^5$ is odd, since

$$g(-x) = (-x)^3 = -x^3 = -g(x)$$

$$\begin{aligned}h(-x) &= (-x)^4 = x^4 = h(x) \\k(-x) &= (-x)^5 = -x^5 = -k(x)\end{aligned}$$

Indeed, we see that a function $y = x^n$ is even, precisely when n is even, and $y = x^n$ is odd, precisely when n is odd. (These examples are in fact the motivation behind defining even and odd functions as in definition 5.9 above.)

Next, in order to determine if the function l is even or odd, we calculate $l(-x)$ and compare it with $l(x)$.

$$\begin{aligned}l(-x) &= 4(-x)^5 + 7(-x)^3 - 2(-x) = -4x^5 - 7x^3 + 2x \\ &= -(4x^5 + 7x^3 - 2x) = -l(x)\end{aligned}$$

Therefore, l is an odd function.

Finally, for $m(x) = x^2 + 5x$, we calculate $m(-x)$ as follows:

$$m(-x) = (-x)^2 + 5(-x) = x^2 - 5x$$

Note, that m is not an even function, since $x^2 - 5x \neq x^2 + 5x$. Furthermore, m is also not an odd function, since $x^2 - 5x \neq -(x^2 + 5x)$. Therefore, m is a function that is *neither even nor odd*. \square

Observation 5.11. An even function f is symmetric with respect to the y -axis (if you reflect the graph of f about the y -axis you get the same graph back), since even functions satisfy $f(-x) = f(x)$:

Example $y = x^2$:

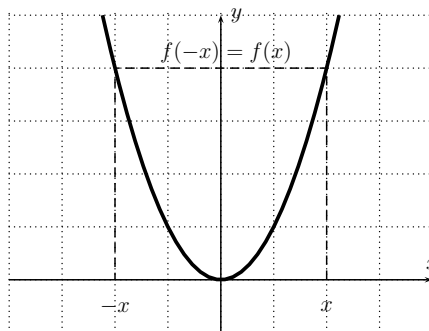

An odd function f is symmetric with respect to the origin (if you reflect the graph of f about the y -axis and then about the x -axis you get the same

graph back), since odd functions satisfy $f(-x) = -f(x)$:

Example $y = x^3$:

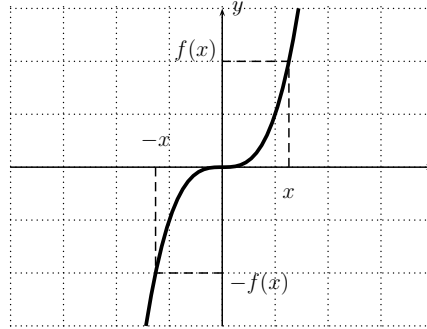

5.3 Exercises

Exercise 5.1. Find a possible formula of the graph displayed below.

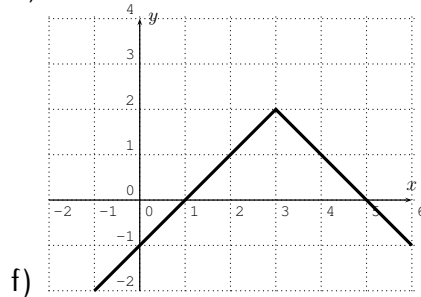
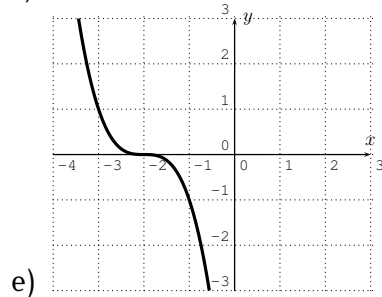
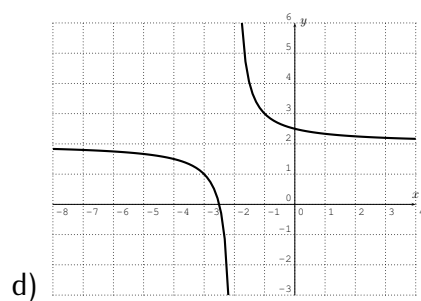
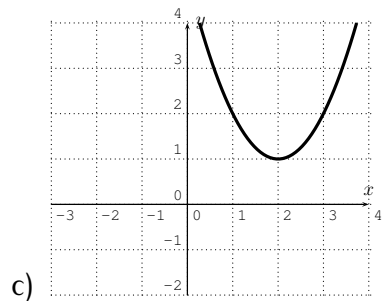
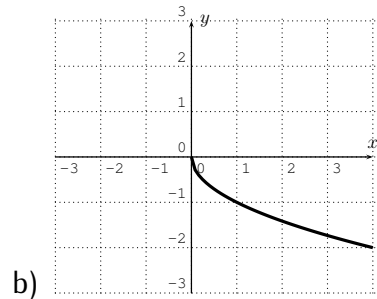
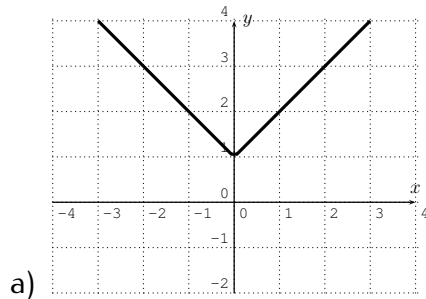

Exercise 5.2. Sketch the graph of the function, based on the basic graphs in Section 5.1 and the transformations described above. Confirm your answer by graphing the function with the calculator.

$$\begin{array}{ll} \text{a) } f(x) = |x| - 3 & \text{b) } f(x) = \frac{1}{x+2} \\ \text{c) } f(x) = -x^2 & \text{d) } f(x) = (x-1)^3 \\ \text{e) } f(x) = \sqrt{-x} & \text{f) } f(x) = 4 \cdot |x-3| \\ \text{g) } f(x) = -\sqrt{x} + 1 & \text{h) } f(x) = \left(\frac{1}{2} \cdot x\right)^2 + 3 \end{array}$$

Exercise 5.3. Consider the graph of $f(x) = x^2 - 7x + 1$. Find the formula of the function that is given by performing the following transformations on the graph.

- Shift the graph of f down by 4.
- Shift the graph of f to the left by 3 units.
- Reflect the graph of f about the x -axis.
- Reflect the graph of f about the y -axis.
- Stretch the graph of f away from the y -axis by a factor 3.
- Compress the graph of f towards the y -axis by a factor 2.

Exercise 5.4. How are the graphs of f and g related?

$$\begin{array}{ll} \text{a) } f(x) = \sqrt{x}, & g(x) = \sqrt{x-5} \\ \text{b) } f(x) = |x|, & g(x) = 2 \cdot |x| \\ \text{c) } f(x) = (x+1)^3, & g(x) = (x-3)^3 \\ \text{d) } f(x) = x^2 + 3x + 5, & g(x) = (2x)^2 + 3(2x)^2 + 5 \\ \text{e) } f(x) = \frac{1}{x+3}, & g(x) = -\frac{1}{x} \\ \text{f) } f(x) = 2 \cdot |x|, & g(x) = |x+1| + 1 \end{array}$$

Exercise 5.5. Determine, if the function is even, odd, or neither.

a) $y = 2x^3$,

b) $y = 5x^2$,

c) $y = 3x^4 - 4x^2 + 5$,

d) $y = 2x^3 + 5x^2$,

e) $y = |x|$,

f) $y = \frac{1}{x}$,

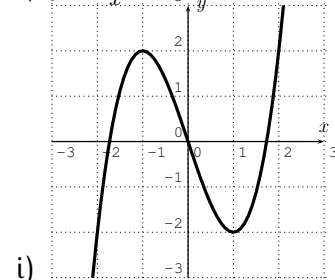
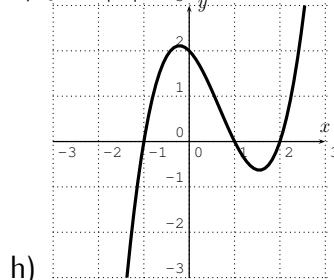
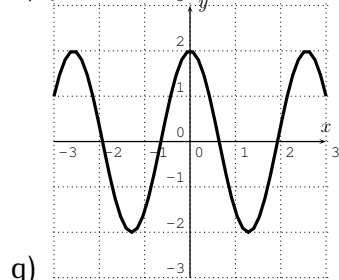

Exercise 5.6. The graph of the function $y = f(x)$ is displayed below.

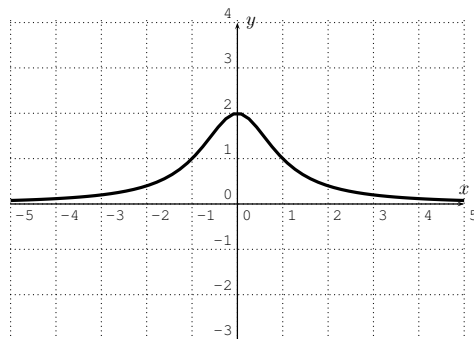

Sketch the graph of the following functions.

- a) $y = f(x) + 1$, b) $y = f(x - 3)$, c) $y = -f(x)$,
d) $y = 2f(x)$, e) $y = f(2x)$, f) $y = f(\frac{1}{2}x)$

Session 6

Operations on functions

6.1 Operations on functions given by formulas

We can combine functions in many different ways. First, note that we can add, subtract, multiply, and divide functions.

Example 6.1. Let $f(x) = x^2 + 5x$ and $g(x) = 7x - 3$. Find the following functions, and state their domain.

$$(f + g)(x), (f - g)(x), (f \cdot g)(x), \text{ and } \left(\frac{f}{g}\right)(x).$$

Solution. The functions are calculated by adding the functions (or subtracting, multiplying, dividing).

$$\begin{aligned}(f + g)(x) &= (x^2 + 5x) + (7x - 3) = x^2 + 12x - 3, \\(f - g)(x) &= (x^2 + 5x) - (7x - 3) \\ &= x^2 + 5x - 7x + 3 = x^2 - 2x + 3, \\(f \cdot g)(x) &= (x^2 + 5x) \cdot (7x - 3) \\ &= 7x^3 - 3x^2 + 35x^2 - 15x = 7x^3 + 32x^2 - 15x, \\ \left(\frac{f}{g}\right)(x) &= \frac{x^2 + 5x}{7x - 3}.\end{aligned}$$

The calculation of these functions was straightforward. To state their domain is also straightforward, except for the domain of the quotient $\frac{f}{g}$. Note, that $f + g$, $f - g$, and $f \cdot g$ are all polynomials. By the standard convention

(Convention 3.4 on page 36) all these functions have the domain \mathbb{R} , that is their domain is all real numbers.

Now, for the domain of $\frac{f}{g}$, we have to be a bit more careful, since the denominator of a fraction cannot be zero. The denominator of $\frac{f}{g}(x) = \frac{x^2+5x}{7x-3}$ is zero, exactly when

$$7x - 3 = 0 \quad \implies \quad 7x = 3 \quad \implies \quad x = \frac{3}{7}.$$

We have to exclude $\frac{3}{7}$ from the domain. The domain of the quotient $\frac{f}{g}$ is therefore $\mathbb{R} - \{\frac{3}{7}\}$. \square

We can formally state the observation we made in the previous example.

Observation 6.2. Let f be a function with domain D_f , and g be a function with domain D_g . A value x can be used as an input of $f + g$, $f - g$, and $f \cdot g$ exactly when x is an input of both f and g . Therefore, the domains of the combined functions are the intersection of the domains D_f and D_g :

$$\begin{aligned} D_{f+g} &= D_f \cap D_g = \{x \mid x \in D_f \text{ and } x \in D_g\}, \\ D_{f-g} &= D_f \cap D_g, \\ D_{f \cdot g} &= D_f \cap D_g. \end{aligned}$$

For the quotient $\frac{f}{g}$, we also have to make sure that the denominator $g(x)$ is not zero.

$$D_{\frac{f}{g}} = \{x \mid x \in D_f, x \in D_g, \text{ and } g(x) \neq 0\}.$$

Example 6.3. Let $f(x) = \sqrt{x+2}$, and let $g(x) = x^2 - 5x + 4$. Find the functions $\frac{f}{g}$ and $\frac{g}{f}$ and state their domains.

Solution. First, the domain of f consists of those numbers x for which the square root is defined. In other words, we need $x + 2 \geq 0$, that is $x \geq -2$, so that the domain of f is $D_f = [-2, \infty)$. On the other hand, the domain of g is all real numbers, $D_g = \mathbb{R}$. Now, we have the quotients

$$\left(\frac{f}{g}\right)(x) = \frac{\sqrt{x+2}}{x^2 - 5x + 4}, \quad \text{and} \quad \left(\frac{g}{f}\right)(x) = \frac{x^2 - 5x + 4}{\sqrt{x+2}}.$$

For the domain of $\frac{f}{g}$, we need to exclude those numbers x for which $x^2 - 5x + 4 = 0$. Thus,

$$x^2 - 5x + 4 = 0 \quad \implies \quad (x - 1)(x - 4) = 0$$

$$\implies x = 1, \text{ or } x = 4.$$

We obtain the domain for $\frac{f}{g}$ as the combined domain for f and g , and exclude 1 and 4. Therefore, $D_{\frac{f}{g}} = [-2, \infty) - \{1, 4\}$.

Now, for $\frac{g}{f}(x) = \frac{x^2 - 5x + 4}{\sqrt{x+2}}$, the denominator becomes zero exactly when

$$x + 2 = 0, \implies x = -2.$$

Therefore, we need to exclude -2 from the domain, that is

$$D_{\frac{g}{f}} = [-2, \infty) - \{-2\} = (-2, \infty).$$

□

Example 6.4. To form the quotient $\frac{f}{g}(x)$ where $f(x) = x^2 - 1$ and $g(x) = x + 1$ we write $\frac{f}{g}(x) = \frac{x^2 - 1}{x + 1} = \frac{(x+1)(x-1)}{x+1} = x - 1$. One might be tempted to say that the domain is all real numbers. But it is not! The domain is all real numbers except -1 , and the last step of the simplification performed above is only valid for $x \neq -1$.

Another operation we can perform is the composition of two functions.

Definition 6.5. Let f and g be functions, and assume that $g(x)$ is in the domain of f . Then define the **composition of f and g** at x to be

$$(f \circ g)(x) := f(g(x)).$$

We can take any x as an input of $f \circ g$ which is an input of g and for which $g(x)$ is an input of f . Therefore, if D_f is the domain of f and D_g is the domain of g , the domain of $D_{f \circ g}$ is

$$D_{f \circ g} = \{ x \mid x \in D_g, g(x) \in D_f \}.$$

Example 6.6. Let $f(x) = 2x^2 + 5x$ and $g(x) = 2 - x$. Find the following compositions

- a) $f(g(3))$, b) $g(f(3))$, c) $f(f(1))$, d) $f(2 \cdot g(5))$, e) $g(g(4) + 5)$.

Solution. We evaluate the expressions, one at a time, as follows:

a) $f(g(3)) = f(2 - 3) = f(-1) = 2 \cdot (-1)^2 + 5 \cdot (-1)$

$$\begin{aligned}
 &= 2 - 5 = -3, \\
 \text{b) } \quad g(f(3)) &= g(2 \cdot 3^2 + 5 \cdot 3) = g(18 + 15) = g(33) \\
 &= 2 - 33 = -31, \\
 \text{c) } \quad f(f(1)) &= f(2 \cdot 1^2 + 5 \cdot 1) = f(2 + 5) = f(7) \\
 &= 2 \cdot 7^2 + 5 \cdot 7 = 98 + 35 = 133, \\
 \text{d) } \quad f(2 \cdot g(5)) &= f(2 \cdot (2 - 5)) = f(2 \cdot (-3)) = f(-6) \\
 &= 2 \cdot (-6)^2 + 5 \cdot (-6) = 72 - 30 = 42, \\
 \text{e) } \quad g(g(4) + 5) &= g((2 - 4) + 5) = g((-2) + 5) = g(3) = 2 - 3 = -1.
 \end{aligned}$$

□

We can also calculate composite functions for arbitrary x in the domain.

Example 6.7. Let $f(x) = x^2 + 1$ and $g(x) = x + 3$. Find the following compositions

$$\text{a) } (f \circ g)(x), \quad \text{b) } (g \circ f)(x), \quad \text{c) } (f \circ f)(x), \quad \text{d) } (g \circ g)(x).$$

Solution. a) There are essentially two ways to evaluate $(f \circ g)(x) = f(g(x))$. We can either first use the explicit formula for $f(x)$ and then the one for $g(x)$, or vice versa. We will evaluate $f(g(x))$ by substituting $g(x)$ into the formula for $f(x)$:

$$\begin{aligned}
 (f \circ g)(x) &= f(g(x)) = (g(x))^2 + 1 = (x + 3)^2 + 1 \\
 &= x^2 + 6x + 9 + 1 = x^2 + 6x + 10.
 \end{aligned}$$

Similarly, we evaluate the other expressions (b)-(d):

$$\begin{aligned}
 \text{b) } \quad (g \circ f)(x) &= g(f(x)) = f(x) + 3 = x^2 + 1 + 3 = x^2 + 4, \\
 \text{c) } \quad (f \circ f)(x) &= f(f(x)) = (f(x))^2 + 1 = (x^2 + 1)^2 + 1 \\
 &= x^4 + 2x^2 + 1 + 1 = x^4 + 2x^2 + 2, \\
 \text{d) } \quad (g \circ g)(x) &= g(g(x)) = g(x) + 3 = x + 3 + 3 = x + 6.
 \end{aligned}$$

□

Example 6.8. Find $(f \circ g)(x)$ and $(g \circ f)(x)$ for the following functions, and state their domains.

$$\begin{aligned}
 \text{a) } \quad f(x) &= \frac{3}{x+2}, & \text{and } g(x) &= x^2 - 3x, \\
 \text{b) } \quad f(x) &= |3x - 2| - 6x + 4, & \text{and } g(x) &= 5x + 1, \\
 \text{c) } \quad f(x) &= \sqrt{\frac{1}{2} \cdot (x - 4)}, & \text{and } g(x) &= 2x^2 + 4.
 \end{aligned}$$

Solution.

a) Composing $f \circ g$, we obtain

$$(f \circ g)(x) = f(g(x)) = \frac{3}{g(x) + 2} = \frac{3}{x^2 - 3x + 2}.$$

The domain is the set of numbers x for which the denominator is non-zero.

$$\begin{aligned} x^2 - 3x + 2 = 0 &\implies (x - 2)(x - 1) = 0 \\ &\implies x = 2 \text{ or } x = 1 \\ &\implies D_{f \circ g} = \mathbb{R} - \{1, 2\}. \end{aligned}$$

Similarly,

$$\begin{aligned} (g \circ f)(x) &= g(f(x)) = f(x)^2 - 3f(x) = \left(\frac{3}{x+2}\right)^2 - 3\frac{3}{x+2} \\ &= \frac{9}{(x+2)^2} - \frac{9}{x+2} = \frac{9 - 9(x+2)}{(x+2)^2} \\ &= \frac{9 - 9x - 18}{(x+2)^2} = \frac{-9x - 9}{(x+2)^2} = \frac{-9 \cdot (x+1)}{(x+2)^2} \end{aligned}$$

The domain is all real numbers except $x = -2$, that is $D_{g \circ f} = \mathbb{R} - \{-2\}$.

b) We calculate the compositions as follows.

$$\begin{aligned} (f \circ g)(x) &= f(g(x)) = |3g(x) - 2| - 6g(x) + 4 \\ &= |3(5x + 1) - 2| - 6(5x + 1) + 4 = |15x + 1| - 30x - 2, \\ (g \circ f)(x) &= g(f(x)) = 5f(x) + 1 = 5 \cdot (|3x - 2| - 6x + 4) + 1 \\ &= 5 \cdot |3x - 2| - 30x + 20 + 1 = 5 \cdot |3x - 2| - 30x + 21. \end{aligned}$$

Since the domains of f and g are all real numbers, so are also the domains for both $f \circ g$ and $g \circ f$.

c) Again we calculate the compositions.

$$\begin{aligned} (f \circ g)(x) &= f(g(x)) = \sqrt{\frac{1}{2} \cdot (g(x) - 4)} = \sqrt{\frac{1}{2} \cdot (2x^2 + 4 - 4)} \\ &= \sqrt{\frac{1}{2} \cdot 2x^2} = \sqrt{x^2} = |x|. \end{aligned}$$

The domain of g is all real numbers, and the outputs $g(x) = 2x^2 + 4$ are all ≥ 4 , (since $2x^2 \geq 0$). Therefore, $g(x)$ is in the domain of f , and we have a combined domain of $f \circ g$ of $D_{f \circ g} = \mathbb{R}$. On the other hand,

$$\begin{aligned}(g \circ f)(x) &= g(f(x)) = 2(f(x))^2 + 4 = 2 \cdot \left(\sqrt{\frac{1}{2} \cdot (x-4)} \right)^2 + 4 \\ &= 2 \cdot \left(\frac{1}{2} \cdot (x-4) \right) + 4 = (x-4) + 4 = x.\end{aligned}$$

The domain of $g \circ f$ consists of all numbers x which are in the domain of f and for which $f(x)$ is in the domain of g . Now, the domain of f consists of all real numbers x that give a non-negative argument in the square-root, that is: $\frac{1}{2}(x-4) \geq 0$. Therefore we must have $x-4 \geq 0$, so that $x \geq 4$, and we obtain the domain $D_f = [4, \infty)$. Since the domain $D_g = \mathbb{R}$, the composition $g \circ f$ has the same domain as f :

$$D_{g \circ f} = D_f = [4, \infty).$$

We remark that at a first glance, we might have expected that $(g \circ f) = x$ has a domain of all real numbers. However, the composition $g(f(x))$ can only have those inputs that are also allowed inputs of f . We see that the domain of a composition is sometimes smaller than the domain that we use via the standard convention (Convention 3.4).

□

6.2 Operations on functions given by tables

We can also combine functions that are defined using tables.

Example 6.9. Let f and g be the functions defined by the following table.

x	1	2	3	4	5	6	7
$f(x)$	6	3	1	4	0	7	6
$g(x)$	4	0	2	5	-2	3	1

Describe the following functions via a table:

- a) $2 \cdot f(x) + 3$, b) $f(x) - g(x)$, c) $f(x + 2)$, d) $g(-x)$.

Solution. For (a) and (b), we obtain by immediate calculation

x	1	2	3	4	5	6	7
$2 \cdot f(x) + 3$	15	9	5	11	3	17	15
$f(x) - g(x)$	2	3	-1	-1	2	4	5

For example, for $x = 3$, we obtain $2 \cdot f(x) + 3 = 2 \cdot f(3) + 3 = 2 \cdot 1 + 3 = 5$ and $f(x) - g(x) = f(3) - g(3) = 1 - 2 = -1$.

For part (c), we have a similar calculation of $f(x + 2)$. For example, for $x = 1$, we get $f(1 + 2) = f(1 + 2) = f(3) = 1$.

x	1	2	3	4	5	6	7	-1	0
$f(x + 2)$	1	4	0	7	6	undef.	undef.	6	3

Note that for the last two inputs $x = 6$ and $x = 7$ the expression $f(x + 2)$ is undefined, since, for example for $x = 6$, it is $f(x + 2) = f(6 + 2) = f(8)$ which is undefined. However, for $x = -1$, we obtain $f(x + 2) = f(-1 + 2) = f(1) = 6$. If we define $h(x) = f(x + 2)$, then the domain of h is therefore $D_h = \{-1, 0, 1, 2, 3, 4, 5\}$.

Finally, for part (d), we need to take x as inputs, for which $g(-x)$ is defined via the table for g . We obtain the following answer.

x	-1	-2	-3	-4	-5	-6	-7
$g(-x)$	4	0	2	5	-2	3	1

□

Example 6.10. Let f and g be the functions defined by the following table.

x	1	3	5	7	9	11
$f(x)$	3	5	11	4	9	7
$g(x)$	7	-6	9	11	9	5

Describe the following functions via a table:

$$\text{a) } f \circ g, \quad \text{b) } g \circ f, \quad \text{c) } f \circ f, \quad \text{d) } g \circ g.$$

Solution. The compositions are calculated by repeated evaluation. For example,

$$(f \circ g)(1) = f(g(1)) = f(7) = 4.$$

The complete answer is displayed below.

x	1	3	5	7	9	11
$(f \circ g)(x)$	4	undef.	9	7	9	11
$(g \circ f)(x)$	-6	9	5	undef.	9	11
$(f \circ f)(x)$	5	11	7	undef.	9	4
$(g \circ g)(x)$	11	undef.	9	5	9	9

□

6.3 Exercises

Exercise 6.1. Find $f + g$, $f - g$, $f \cdot g$ for the functions below. State their domain.

- a) $f(x) = x^2 + 6x$, and $g(x) = 3x - 5$,
 b) $f(x) = x^3 + 5$, and $g(x) = 5x^2 + 7$,
 c) $f(x) = 3x + 7\sqrt{x}$, and $g(x) = 2x^2 + 5\sqrt{x}$,
 d) $f(x) = \frac{1}{x+2}$, and $g(x) = \frac{5x}{x+2}$,
 e) $f(x) = \sqrt{x-3}$, and $g(x) = 2\sqrt{x-3}$,
 f) $f(x) = x^2 + 2x + 5$, and $g(x) = 3x - 6$,
 g) $f(x) = x^2 + 3x$, and $g(x) = 2x^2 + 3x + 4$.

Exercise 6.2. Find $\frac{f}{g}$, and $\frac{g}{f}$ for the functions below. State their domain.

- a) $f(x) = 3x + 6$, and $g(x) = 2x - 8$,
 b) $f(x) = x + 2$, and $g(x) = x^2 - 5x + 4$,
 c) $f(x) = \frac{1}{x-5}$, and $g(x) = \frac{x-2}{x+3}$,
 d) $f(x) = \sqrt{x+6}$, and $g(x) = 2x + 5$,
 e) $f(x) = x^2 + 8x - 33$, and $g(x) = \sqrt{x}$.

Exercise 6.3. Let $f(x) = 2x - 3$ and $g(x) = 3x^2 + 4x$. Find the following compositions

- a) $f(g(2))$, b) $g(f(2))$, c) $f(f(5))$, d) $f(5g(-3))$,
 e) $g(f(2) - 2)$, f) $f(f(3) + g(3))$, g) $g(f(2 + x))$, h) $f(f(-x))$,
 i) $f(f(-3) - 3g(2))$, j) $f(f(f(2)))$, k) $f(x + h)$, l) $g(x + h)$.

Exercise 6.4. Find the composition $(f \circ g)(x)$ for the functions:

- a) $f(x) = 3x - 5$, and $g(x) = 2x + 3$,
 b) $f(x) = x^2 + 2$, and $g(x) = x + 3$,
 c) $f(x) = x^2 - 3x + 2$, and $g(x) = 2x + 1$,
 d) $f(x) = x^2 + \sqrt{x+3}$, and $g(x) = x^2 + 2x$,
 e) $f(x) = \frac{2}{x+4}$, and $g(x) = x + h$,
 f) $f(x) = x^2 + 4x + 3$, and $g(x) = x + h$.

Exercise 6.5. Find the compositions

$$(f \circ g)(x), \quad (g \circ f)(x), \quad (f \circ f)(x), \quad (g \circ g)(x)$$

for the following functions:

- a) $f(x) = 2x + 4$, and $g(x) = x - 5$,
 b) $f(x) = x + 3$, and $g(x) = x^2 - 2x$,
 c) $f(x) = 2x^2 - x - 6$, and $g(x) = \sqrt{3x+2}$,
 d) $f(x) = \frac{1}{x+3}$, and $g(x) = \frac{1}{x} - 3$,
 e) $f(x) = (2x - 7)^2$, and $g(x) = \frac{\sqrt{x+7}}{2}$.

Exercise 6.6. Let f and g be the functions defined by the following table. Complete the table given below.

x	1	2	3	4	5	6	7
$f(x)$	4	5	7	0	-2	6	4
$g(x)$	6	-8	5	2	9	11	2
$f(x) + 3$							
$4g(x) + 5$							
$g(x) - 2f(x)$							
$f(x + 3)$							

Exercise 6.7. Let f and g be the functions defined by the following table. Complete the table by composing the given functions.

x	1	2	3	4	5	6
$f(x)$	3	1	2	5	6	3
$g(x)$	5	2	6	1	2	4
$(g \circ f)(x)$						
$(f \circ g)(x)$						
$(f \circ f)(x)$						
$(g \circ g)(x)$						

Exercise 6.8. Let f and g be the functions defined by the following table. Complete the table by composing the given functions.

x	0	2	4	6	8	10	12
$f(x)$	4	8	5	6	12	-1	10
$g(x)$	10	2	0	-6	7	2	8
$(g \circ f)(x)$							
$(f \circ g)(x)$							
$(f \circ f)(x)$							
$(g \circ g)(x)$							

Session 7

The inverse of a function

7.1 One-to-one functions

We have seen that some functions f may have the same outputs for different inputs. For example for $f(x) = x^2$, the inputs $x = 2$ and $x = -2$ have the same output $f(2) = 4$ and $f(-2) = 4$. A function is one-to-one, precisely when this is *not* the case.

Definition 7.1. A function f is called **one-to-one** (or **injective**), if two different inputs $x_1 \neq x_2$ always have different outputs $f(x_1) \neq f(x_2)$.

Example 7.2. As was noted above, the function $f(x) = x^2$ is not one-to-one, because, for example, for inputs 2 and -2 , we have the same output

$$f(-2) = (-2)^2 = 4, \quad f(2) = 2^2 = 4.$$

On the other hand, $g(x) = x^3$ is one-to-one, since, for example, for inputs -2 and 2, we have different outputs:

$$g(-2) = (-2)^3 = -8, \quad g(2) = 2^3 = 8.$$

The difference between the functions f and g can be seen from their graphs.

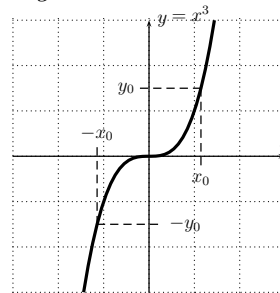
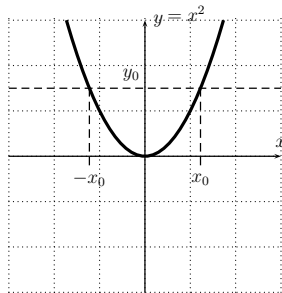

The graph of $f(x) = x^2$ on the left has for different inputs (x_0 and $-x_0$) the same output ($y_0 = (x_0)^2 = (-x_0)^2$). This is shown in the graph since the horizontal line at y_0 intersects the graph at two different points. In general, two inputs that have the same output y_0 give two points on the graph which also lie on the horizontal line at y_0 .

Now, the graph of $g(x) = x^3$ on the right intersects with a horizontal line at some y_0 only once. This shows that for two different inputs, we can never have the same output y_0 , so that the function g is one-to-one.

We can summarize the observation of the last example in the following statement.

Observation 7.3 (Horizontal Line Test). A function is one-to-one exactly when every horizontal line intersects the graph of the function at most once.

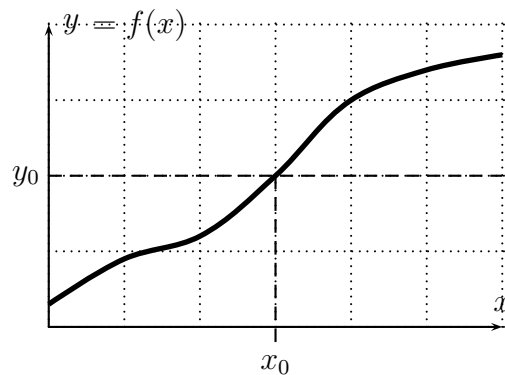

Example 7.4. Which of the following are or represent one-to-one functions?

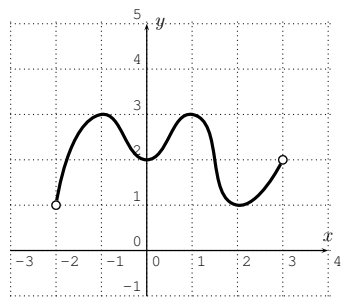

a)

c) $f(x) = -x^3 + 6x^2 - 13x + 12$

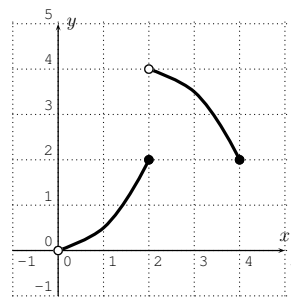

b)

d) $f(x) = x^3 - 2x^2 + 3$

Solution. We use the horizontal line test to see which functions are one-to-one. For (a) and (b), we see that the functions are *not* one-to-one since there

is a horizontal line that intersects with the graph more than once:

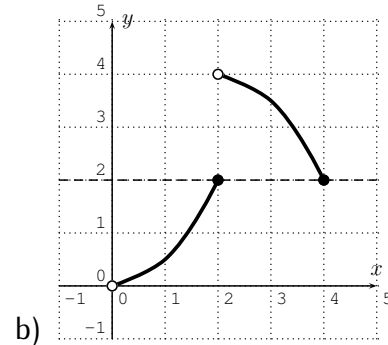
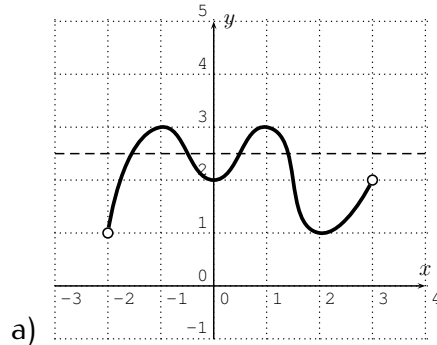

For (c), using the calculator to graph the function $f(x) = -x^3 + 6x^2 - 13x + 12$, we see that all horizontal lines intersect the graph exactly once. Therefore the function in part (c) is one-to-one. The function in part (d) however has a graph that intersects some horizontal line in several points. Therefore $f(x) = x^3 - 2x^2 + 3$ is not one-to-one:

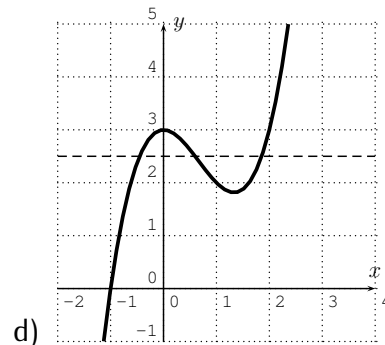
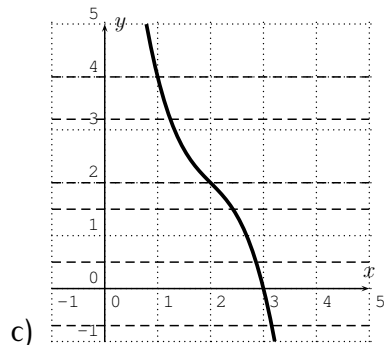

□

7.2 Inverse function

A function is one-to-one, when each output is determined by exactly one input. Therefore we can construct a new function, called the inverse function, where we reverse the roles of inputs and outputs. For example, when $y = x^3$,

each y_0 comes from exactly one x_0 as shown in the picture below:

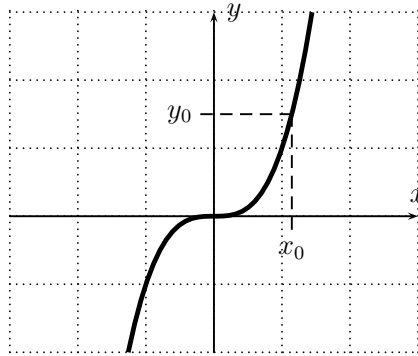

The inverse function assigns to the *input* y_0 the *output* x_0 .

Definition 7.5. Let f be a function with domain D_f and range R_f , and assume that f is one-to-one. The inverse of f is a function f^{-1} so that

$$f(x) = y \quad \text{means precisely that} \quad f^{-1}(y) = x.$$

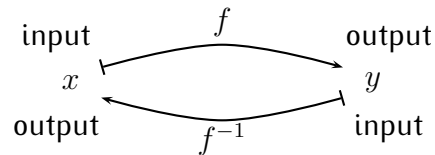

Here the outputs of f are the inputs of f^{-1} , and the inputs of f are the outputs of f^{-1} . Therefore, the inverse function f^{-1} has a domain equal to the range of f , $D_{f^{-1}} = R_f$, and f^{-1} has a range equal to the domain of f , $R_{f^{-1}} = D_f$. In short, when f is a function $f : D_f \rightarrow R_f$, then the inverse function f^{-1} is a function $f^{-1} : R_f \rightarrow D_f$.

The inverse function reverses the roles of inputs and outputs.

Example 7.6. Find the inverse of the following function via algebra.

a) $f(x) = 2x - 7$

b) $g(x) = \sqrt{x + 2}$

c) $h(x) = \frac{1}{x+4}$

d) $j(x) = \frac{x+1}{x+2}$

e) $k(x) = (x - 2)^2 + 3$ for $x \geq 2$

Solution. a) First, reverse the role of input and output in $y = 2x - 7$ by exchanging the variables x and y . That is, we write $x = 2y - 7$. We need to solve this for y :

$$\xrightarrow{(\text{add } 7)} \quad x + 7 = 2y \implies y = \frac{x + 7}{2}.$$

Therefore, we obtain that the inverse of f is $f^{-1}(x) = \frac{x+7}{2}$.

For the other parts, we always exchange x and y and solve for y :

b) Write $y = \sqrt{x+2}$ and exchange x and y :

$$\begin{aligned} x = \sqrt{y+2} &\implies x^2 = y+2 &\implies y = x^2 - 2 \\ &\implies g^{-1}(x) = x^2 - 2 \end{aligned}$$

c) Write $y = \frac{1}{x+4}$ and exchange x and y :

$$\begin{aligned} x = \frac{1}{y+4} &\implies y+4 = \frac{1}{x} &\implies y = \frac{1}{x} - 4 \\ &\implies h^{-1}(x) = \frac{1}{x} - 4 \end{aligned}$$

d) Write $y = \frac{x+1}{x+2}$ and exchange x and y :

$$\begin{aligned} x = \frac{y+1}{y+2} &\stackrel{\times(y+2)}{\implies} x(y+2) = y+1 &\implies xy + 2x = y+1 \\ &\implies xy - y = 1 - 2x &\implies y(x-1) = 1 - 2x \\ &\implies y = \frac{1-2x}{x-1} &\implies j^{-1}(x) = \frac{1-2x}{x-1}, \end{aligned}$$

e) Write $y = (x-2)^2 + 3$ and exchange x and y :

$$\begin{aligned} x = (y-2)^2 + 3 &\implies x-3 = (y-2)^2 &\implies \sqrt{x-3} = y-2 \\ &\implies y = 2 + \sqrt{x-3} &\implies k^{-1}(x) = 2 + \sqrt{x-3} \end{aligned}$$

□

The function in the last example is not one-to-one when allowing x to be any real number. This is why we had to restrict the example to the inputs $x \geq 2$. We exemplify the situation in the following example.

Example 7.7. Note, that the function $y = x^2$ can be restricted to a one-to-one function by choosing the domain to be all non-negative numbers $[0, \infty)$ or by choosing the domain to be all non-positive numbers $(-\infty, 0]$.

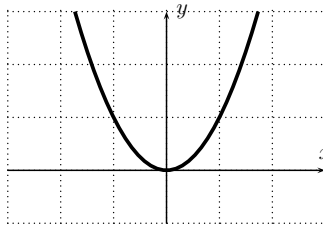

Let $f : [0, \infty) \rightarrow [0, \infty)$ be the function $f(x) = x^2$, so that f has a domain of all non-negative numbers. Then, the inverse is the function $f^{-1}(x) = \sqrt{x}$.

On the other hand, we can take $g(x) = x^2$ whose domain consists of all non-positive numbers $(-\infty, 0]$, that is $g : (-\infty, 0] \rightarrow [0, \infty)$. Then, the inverse function g^{-1} must reverse domain and range, that is $g^{-1} : [0, \infty) \rightarrow (-\infty, 0]$. The inverse is obtained by exchanging x and y in $y = x^2$ as follows:

$$x = y^2 \implies y = \pm\sqrt{x} \implies g^{-1}(x) = -\sqrt{x}.$$

Example 7.8. Restrict the function to a one-to-one function. Find the inverse function, if possible.

a) $f(x) = (x + 3)^2 + 1$, b) $g(x) = \frac{1}{(x - 2)^2}$, c) $h(x) = x^3 - 3x^2$.

Solution. The graphs of f and g are displayed below.

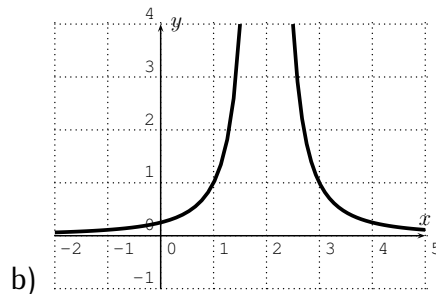
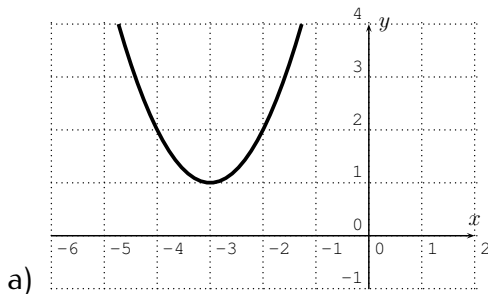

a) The graph shows that f is one-to-one when restricted to all numbers $x \geq -3$, which is the choice we make to find an inverse function. Next, we replace x and y in $y = (x + 3)^2 + 1$ to give $x = (y + 3)^2 + 1$. When solving this for y , we must now remember that our choice of $x \geq -3$ becomes $y \geq -3$ after replacing x with y . We now solve for y .

$$\begin{aligned} x = (y + 3)^2 + 1 &\implies x - 1 = (y + 3)^2 &\implies y + 3 = \pm\sqrt{x - 1} \\ &\implies y = -3 \pm \sqrt{x - 1} \end{aligned}$$

Since we have chosen the restriction of $y \geq -3$, we use the expression with the positive sign, $y = -3 + \sqrt{x - 1}$, so that the inverse function is $f^{-1}(x) = -3 + \sqrt{x - 1}$.

b) For the function g , the graph shows that we can restrict g to $x > 2$ to obtain a one-to-one function. The inverse for this choice is given as follows.

Replacing x and y in $y = \frac{1}{(x-2)^2}$ gives $x = \frac{1}{(y-2)^2}$, which we solve this for y under the condition $y > 2$.

$$\begin{aligned} x = \frac{1}{(y-2)^2} &\implies (y-2)^2 = \frac{1}{x} &\implies y-2 = \pm \frac{1}{\sqrt{x}} \\ &\implies y = 2 \pm \frac{1}{\sqrt{x}} &\implies g^{-1}(x) = 2 + \frac{1}{\sqrt{x}} \end{aligned}$$

c) Finally, $h(x) = x^3 - 3x^2$ can be graphed with the calculator as follows:



The picture on the right shows that the approximation of the local minimum is (approximately) at $x = 2$. Therefore, if we restrict h to all $x \geq 2$, we obtain a one-to-one function. We replace x and y in $y = x^3 - 3x^2$, so that the inverse function is obtained by solving the equation $x = y^3 - 3y^2$ for y . However, this equation is quite complicated and solving it is beyond our capabilities at this time. Therefore we simply say that $h^{-1}(x)$ is that $y \geq 2$ for which $y^3 - 3y^2 = x$, and leave the example with this. \square

Let f be a one-to-one function. If f maps x_0 to $y_0 = f(x_0)$, then f^{-1} maps y_0 to x_0 . In other words, the inverse function is precisely the function for which

$$\boxed{f^{-1}(f(x_0)) = f^{-1}(y_0) = x_0} \quad \text{and} \quad \boxed{f(f^{-1}(y_0)) = f(x_0) = y_0}.$$

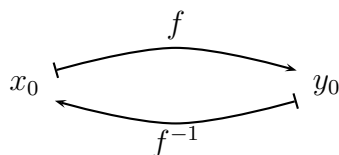

Observation 7.9. Let f and g be two one-to-one functions. Then f and g are inverses of each other exactly when

$$\boxed{f(g(x)) = x} \quad \text{and} \quad \boxed{g(f(x)) = x} \quad \text{for all } x.$$

In this case we write that $g = f^{-1}$ and $f = g^{-1}$.

Example 7.10. Are the following functions inverse to each other?

- a) $f(x) = 5x + 7, \quad g(x) = \frac{x-7}{5},$
 b) $f(x) = \frac{3}{x-6}, \quad g(x) = \frac{3}{x} + 6,$
 c) $f(x) = \sqrt{x} - 3, \quad g(x) = x^2 + 3.$

Solution. We calculate the compositions $f(g(x))$ and $g(f(x))$.

$$\begin{aligned} \text{a) } f(g(x)) &= f\left(\frac{x-7}{5}\right) = 5 \cdot \frac{x-7}{5} + 7 = (x-7) + 7 = x, \\ g(f(x)) &= g(5x+7) = \frac{(5x+7)-7}{5} = \frac{5x}{5} = x, \\ \text{b) } f(g(x)) &= f\left(\frac{3}{x} + 6\right) = \frac{3}{\left(\frac{3}{x} + 6\right) - 6} = \frac{3}{\frac{3}{x}} = 3 \cdot \frac{x}{3} = x, \\ g(f(x)) &= g\left(\frac{3}{x-6}\right) = \frac{3}{\frac{3}{x-6}} + 6 = 3 \cdot \frac{x-6}{3} + 6 = (x-6) + 6 = x. \end{aligned}$$

Using the Observation 7.9, we see that in both part (a) and (b), the functions are inverse to each other. For part (c), we calculate for a general x in the domain of g :

$$f(g(x)) = \sqrt{x^2 + 3} - 3 \neq x.$$

It is enough to show that for one composition $(f \circ g)(x)$ does not equal x to conclude that f and g are not inverses. (It is not necessary to also calculate the other composition $g(f(x))$.) \square

Warning 7.11. It is true that when we have one relation $f(g(x)) = x$, then we also have the other relation $g(f(x)) = x$. Nevertheless, we recommend to always check *both* equations. The reason is that it is easy to mistake one of the relations, when not being careful about the domain and range.

For example, let $f(x) = x^2$ and $g(x) = -\sqrt{x}$. Then, naively, we would calculate $f(g(x)) = (-\sqrt{x})^2 = x$ and $g(f(x)) = -\sqrt{x^2} = -|x|$, so that the first equation would say f and g are inverses, whereas the second equation says they are not inverses.

We can resolve the apparent contradiction by restricting f to a one-to-one function. For example, if we take the domain of f to be all positive numbers or zero, $D_f = [0, \infty)$, then $f(g(x)) = f(-\sqrt{x})$ which is undefined, since f only takes non-negative inputs. Also, it is $g(f(x)) = -\sqrt{x^2} = -x$. Therefore, the functions f and g are *not* inverse to each other!

On the other hand, if we restrict the function $f(x) = x^2$ to all negative numbers and zero, $D_f = (-\infty, 0]$, then $f(g(x)) = (-\sqrt{x})^2 = x$, since now f is defined for the negative input $-\sqrt{x}$. Also, for a negative number $x < 0$, it is $g(f(x)) = -\sqrt{x^2} = -|x| = x$. So, in this case, f and g are inverse to each other!

Our last observation concerns the graph of inverse functions. If $f(x_0) = y_0$ then $f^{-1}(y_0) = x_0$, and the point $P(x_0, y_0)$ is on the graph of f , whereas the point $Q(y_0, x_0)$ is on the graph of f^{-1} .

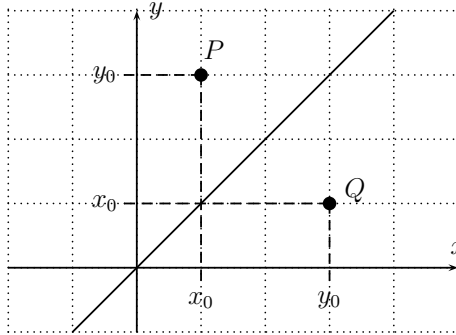

We see that Q is the reflection of P along the diagonal $y = x$. Since this is true for any point on the graph of f and f^{-1} , we have the following general observation.

Observation 7.12. The graph of f^{-1} is the graph of f reflected along the diagonal.

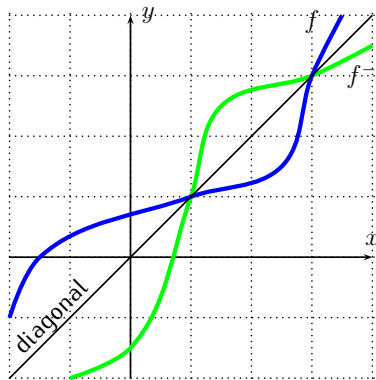

Example 7.13. Find the graph of the inverse function of the function given below.

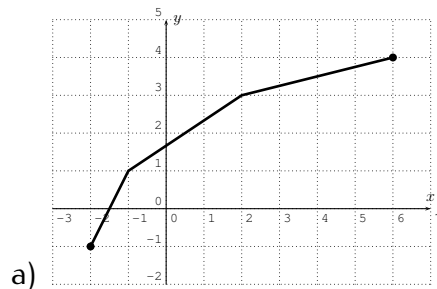

b) $f(x) = (x + 1)^3$

Solution. Carefully reflecting the graphs given in part (a) and (b) gives the following solution. The function $f(x) = (x + 1)^3$ in part (b) can be graphed with a calculator first.

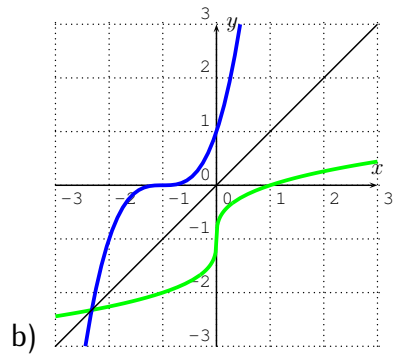
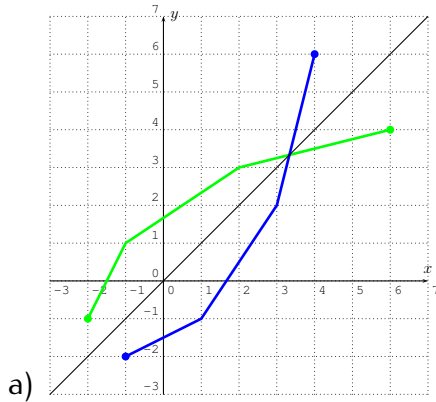

□

7.3 Exercises

Exercise 7.1. Use the horizontal line test to determine if the function is one-to-one.

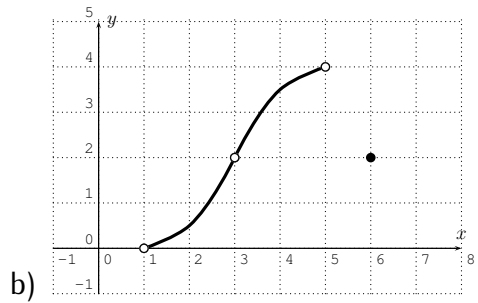
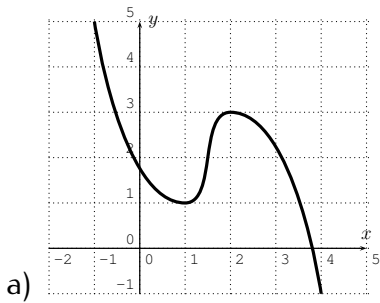

c) $f(x) = x^2 + 2x + 5$

e) $f(x) = x^3 - 5x^2$

g) $f(x) = \sqrt{x+2}$

d) $f(x) = x^2 - 14x + 29$

f) $f(x) = \frac{x^2}{x^2-3}$

h) $f(x) = \sqrt{|x+2|}$

Exercise 7.2. Find the inverse of the function f and check your solution.

a) $f(x) = 4x + 9$

c) $f(x) = \sqrt{x+8}$

e) $f(x) = 6 \cdot \sqrt{-x-2}$

g) $f(x) = (2x+5)^3$

b) $f(x) = -8x - 3$

d) $f(x) = \sqrt{3x+7}$

f) $f(x) = x^3$

h) $f(x) = 2 \cdot x^3 + 5$

- i) $f(x) = \frac{1}{x}$ j) $f(x) = \frac{1}{x-1}$ k) $f(x) = \frac{1}{\sqrt{x-2}}$
 l) $f(x) = \frac{-5}{4-x}$ m) $f(x) = \frac{x}{x+2}$ n) $f(x) = \frac{3x}{x-6}$
 o) $f(x) = \frac{x+2}{x+3}$ p) $f(x) = \frac{7-x}{x-5}$ q) f given by the table below:

x	2	4	6	8	10	12
$f(x)$	3	7	1	8	5	2

Exercise 7.3. Restrict the domain of the function f in such a way that f becomes a one-to-one function. Find the inverse of f with the restricted domain.

- a) $f(x) = x^2$ b) $f(x) = (x+5)^2 + 1$
 c) $f(x) = |x|$ d) $f(x) = |x-4| - 2$
 e) $f(x) = \frac{1}{x^2}$ f) $f(x) = \frac{-3}{(x+7)^2}$
 g) $f(x) = x^4$ h) $f(x) = \frac{(x-3)^4}{10}$

Exercise 7.4. Determine whether the following functions f and g are inverse to each other.

- a) $f(x) = x + 3$, and $g(x) = x - 3$,
 b) $f(x) = -x - 4$, and $g(x) = 4 - x$,
 c) $f(x) = 2x + 3$, and $g(x) = x - \frac{3}{2}$,
 d) $f(x) = 6x - 1$, and $g(x) = \frac{x+1}{6}$,
 e) $f(x) = x^3 - 5$, and $g(x) = 5 + \sqrt[3]{x}$,
 f) $f(x) = \frac{1}{x-2}$, and $g(x) = \frac{1}{x} + 2$.

Exercise 7.5. Draw the graph of the inverse of the function given below.

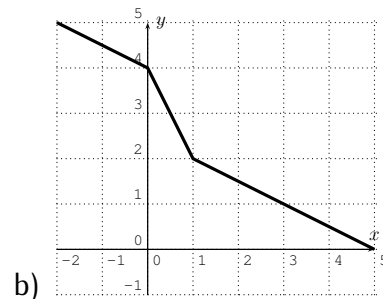
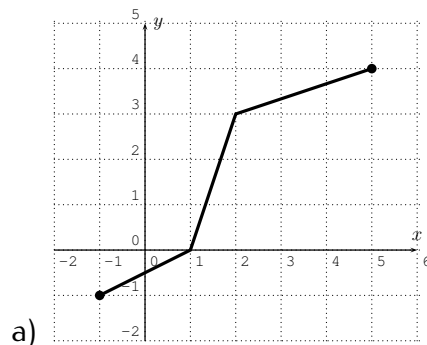

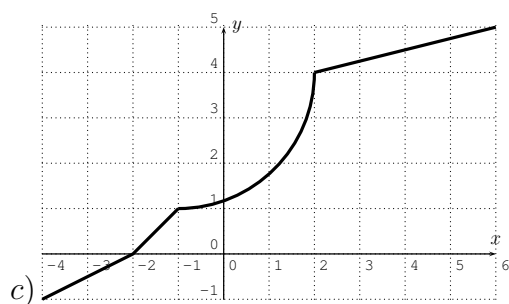

d) $f(x) = \sqrt{x}$

e) $f(x) = x^3 - 4$

f) $f(x) = 2x - 4$

g) $f(x) = 2^x$

h) $f(x) = \frac{1}{x-2}$ for $x > 2$

i) $f(x) = \frac{1}{x-2}$ for $x < 2$.

Review of functions and graphs

Exercise 1.1. Find all solutions of the equation: $|3x - 9| = 6$

Exercise 1.2. Find the equation of the line displayed below.

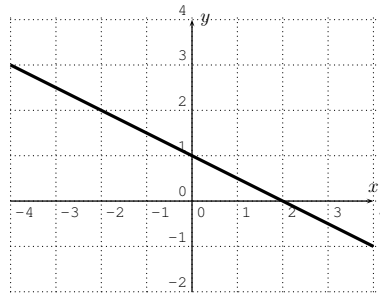

Exercise 1.3. Find the solution of the equation: $x^3 - 3x^2 + 2x - 2 = 0$
Approximate your answer to the nearest hundredth.

Exercise 1.4. Let $f(x) = x^2 - 2x + 5$. Simplify the difference quotient $\frac{f(x+h)-f(x)}{h}$ as much as possible.

Exercise 1.5. Consider the following graph of a function f .

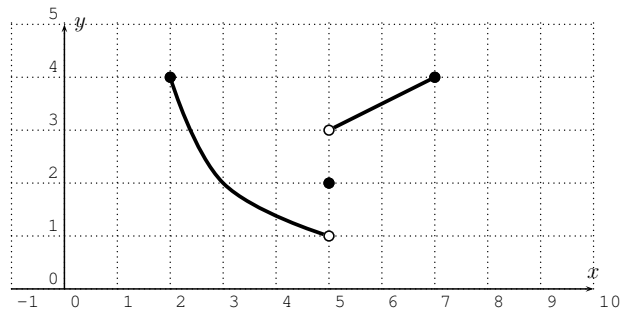

Find: domain of f , range of f , $f(3)$, $f(5)$, $f(7)$, $f(9)$.

Exercise I.6. Find the formula of the graph displayed below.

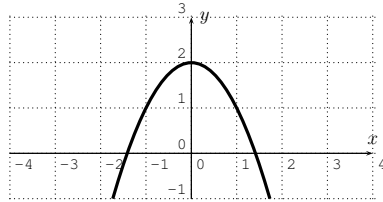

Exercise I.7. Let $f(x) = 5x + 4$ and $g(x) = x^2 + 8x + 7$. Find the quotient $(\frac{f}{g})(x)$ and state its domain.

Exercise I.8. Let $f(x) = x^2 + \sqrt{x - 3}$ and $g(x) = 2x - 3$. Find the composition $(f \circ g)(x)$ and state its domain.

Exercise I.9. Consider the assignments for f and g given by the table below.

x	2	3	4	5	6
$f(x)$	5	0	2	4	2
$g(x)$	6	2	3	4	1

Is f a function? Is g a function? Write the composed assignment for $(f \circ g)(x)$ as a table.

Exercise I.10. Find the inverse of the function $f(x) = \frac{1}{2x+5}$.

Part II

Polynomials and rational functions

Session 8

Dividing polynomials

We now start our discussion of specific classes of examples of functions. The first class of functions that we discuss are polynomials and rational functions. Let us first recall the definition of polynomials and rational functions.

Definition 8.1. A **monomial** is a number, a variable, or a product of numbers and variables. A **polynomial** is a sum (or difference) of monomials.

Example 8.2. The following are examples of monomials:

$$5, \quad x, \quad 7x^2y, \quad -12x^3y^2z^4, \quad \sqrt{2} \cdot a^3n^2xy$$

The following are examples of polynomials:

$$x^2 + 3x - 7, \quad 4x^2y^3 + 2x + z^3 + 4mn^2, \quad -5x^3 - x^2 - 4x - 9, \quad 5x^2y^4$$

In particular, every monomial is also a polynomial.

We are mainly interested in polynomials in one variable x , and consider these as functions. For example, $f(x) = x^2 + 3x - 7$ is such a function.

Definition 8.3. A **polynomial** is a function f of the form

$$f(x) = a_nx^n + a_{n-1}x^{n-1} + \cdots + a_2x^2 + a_1x + a_0,$$

for some real (or complex) numbers a_0, a_1, \dots, a_n . The domain of a polynomial f is all real numbers (see our standard convention 3.4).

The numbers a_0, a_1, \dots, a_n are called **coefficients**. For each k , the number a_k is the **coefficient of x^k** . The number a_n is called the **leading coefficient** and n is the **degree** of the polynomial.

The zeros of a polynomial are usually referred to as **roots**. Therefore x is a root of a polynomial f precisely when $f(x) = 0$.

Definition 8.4. A **rational function** is a fraction of two polynomials $f(x) = \frac{g(x)}{h(x)}$, where $g(x)$ and $h(x)$ are both polynomials. The domain of f is all real numbers for which the denominator $h(x)$ is not zero:

$$D_f = \{ x \mid h(x) \neq 0 \}.$$

Example 8.5. The following are examples of rational functions:

$$f(x) = \frac{-3x^2 + 7x - 5}{2x^3 + 4x^2 + 3x + 1}, \quad f(x) = \frac{1}{x}, \quad f(x) = -x^2 + 3x + 5.$$

8.1 Long division

We now show how to divide two polynomials. The method is similar to the long division of natural numbers. Our first example shows the procedure in full detail.

Example 8.6. Divide the following fractions via long division:

$$\text{a) } \frac{3571}{11} \qquad \text{b) } \frac{x^3 + 5x^2 + 4x + 2}{x + 3}$$

Solution. a) Recall the procedure for long division of natural numbers:

$$\begin{array}{r} 324 \\ 11 \overline{) 3571} \\ \underline{-33} \\ 271 \\ \underline{-22} \\ 51 \\ \underline{-44} \\ 7 = \text{remainder} \end{array}$$

The steps above are performed as follows. First, we find the largest multiple of 11 less or equal to 35. The answer 3 is written as the first digit on the top line. Multiply 3 times 11, and subtract the answer 33 from the first two digits 35 of the dividend. The remaining digits 71 are copied below to give 271. Now we repeat the procedure, until we arrive at the remainder 7. In short, what we have shown is that:

$$3571 = 324 \cdot 11 + 7 \quad \text{or alternatively,} \quad \frac{3571}{11} = 324 + \frac{7}{11}.$$

b) We repeat the steps from part (a) as follows. First, write the dividend and divisor in the above format:

$$x + 3 \overline{) x^3 + 5x^2 + 4x + 2}$$

Next, consider the highest term x^3 of the dividend and the highest term x of the divisor. Since $\frac{x^3}{x} = x^2$, we start with the first term x^2 of the quotient:

$$\text{Step 1: } x + 3 \overline{) x^3 + 5x^2 + 4x + 2} \quad x^2$$

Multiply x^2 by the divisor $x + 3$ and write it below the dividend:

$$\text{Step 2: } x + 3 \overline{) x^3 + 5x^2 + 4x + 2} \quad x^2$$

$$\quad \quad \quad x^3 + 3x^2$$

Since we need to subtract $x^3 + 3x^2$, so we equivalently add its negative (don't forget to distribute the negative):

$$\text{Step 3: } x + 3 \overline{) x^3 + 5x^2 + 4x + 2} \quad x^2$$

$$\quad \quad \quad \underline{-(x^3 + 3x^2)}$$

$$\quad \quad \quad 2x^2$$

Now, carry down the remaining terms of the dividend:

$$\text{Step 4: } x + 3 \overline{) x^3 + 5x^2 + 4x + 2} \quad x^2$$

$$\quad \quad \quad \underline{-(x^3 + 3x^2)}$$

$$\quad \quad \quad 2x^2 + 4x + 2$$

Now, repeat steps 1-4 for the remaining polynomial $2x^2 + 4x + 2$. The outcome after going through steps 1-4 is the following:

$$x + 3 \overline{) x^3 + 5x^2 + 4x + 2} \quad x^2 + 2x \quad (\text{add } \frac{2x^2}{x} = 2x)$$

$$\quad \quad \quad \underline{-(x^3 + 3x^2)}$$

$$\quad \quad \quad 2x^2 + 4x + 2$$

$$\quad \quad \quad \underline{-(2x^2 + 6x)} \quad (\text{multiply } 2x \text{ by } (x + 3))$$

$$\quad \quad \quad -2x + 2 \quad (\text{subtract from the above})$$

Since the remainder is zero, we succeeded in factoring $4x^3 + 2x^2 + 6x + 18$:

$$4x^3 + 2x^2 + 6x + 18 = (2x^2 - 2x + 6) \cdot (2x + 3)$$

d) The last example has a divisor that is a polynomial of degree 2. Therefore, the remainder is not a number, but a polynomial of degree 1.

$$\begin{array}{r}
 x^2 + 3x + 1 \overline{) \begin{array}{r} x^3 + x^2 + 2x + 1 \\ -(x^3 + 3x^2 + x) \\ \hline -2x^2 + x + 1 \\ -(-2x^2 - 6x - 2) \\ \hline 7x + 3 \end{array} \\
 \end{array}$$

Here, the remainder is $r(x) = 7x + 3$.

$$\frac{x^3 + x^2 + 2x + 1}{x^2 + 3x + 1} = x - 2 + \frac{7x + 3}{x^2 + 3x + 1}$$

□

Note 8.9. The divisor $g(x)$ is a factor of $f(x)$ exactly when the remainder $r(x)$ is zero, that is:

$$f(x) = q(x) \cdot g(x) \iff r(x) = 0.$$

For example, in the above Example 8.8, only part (c) results in a factorization of the dividend, since this is the only part with remainder zero.

8.2 Dividing by $(x - c)$

We now restrict our attention to the case where the divisor is $g(x) = x - c$ for some real number c . In this case, the remainder r of the division $f(x)$ by $g(x)$ is a real number. We make the following observations.

Observation 8.10. Assume that $g(x) = x - c$, and the long division of $f(x)$ by $g(x)$ has remainder r , that is,

$$\text{Assumption: } f(x) = q(x) \cdot (x - c) + r.$$

When we evaluate both sides in the above equation at $x = c$ we see that $f(c) = q(c) \cdot (c - c) + r = q(c) \cdot 0 + r = r$. In short:

$$\boxed{\text{The remainder when dividing } f(x) \text{ by } (x - c) \text{ is } r = f(c).} \quad (8.3)$$

In particular:

$$\boxed{f(c) = 0 \iff g(x) = x - c \text{ is a factor of } f(x).} \quad (8.4)$$

The above statement (8.3) is called the **remainder theorem**, and (8.4) is called the **factor theorem**.

Example 8.11. Find the remainder of dividing $f(x) = x^2 + 3x + 2$ by

$$\text{a) } x - 3, \quad \text{b) } x + 4, \quad \text{c) } x + 1, \quad \text{d) } x - \frac{1}{2}.$$

Solution. By Observation 8.10, we know that the remainder r of the division by $x - c$ is $f(c)$. Thus, the remainder for part (a), when dividing by $x - 3$ is

$$r = f(3) = 3^2 + 3 \cdot 3 + 2 = 9 + 9 + 2 = 20.$$

For (b), note that $g(x) = x + 4 = x - (-4)$, so that we take $c = -4$ for our input giving that $r = f(-4) = (-4)^2 + 3 \cdot (-4) + 2 = 16 - 12 + 2 = 6$. Similarly, the other remainders are:

$$\text{c) } r = f(-1) = (-1)^2 + 3 \cdot (-1) + 2 = 1 - 3 + 2 = 0,$$

$$\text{d) } r = f\left(\frac{1}{2}\right) = \left(\frac{1}{2}\right)^2 + \frac{1}{2} \cdot 3 + 2 = \frac{1}{4} + \frac{3}{2} + 2 = \frac{1 + 6 + 8}{4} = \frac{15}{4}.$$

Note that in part (c), we found a remainder 0, so that $(x + 1)$ is a factor of $f(x)$. \square

Example 8.12. Determine whether $g(x)$ is a factor of $f(x)$.

$$\text{a) } f(x) = x^3 + 2x^2 + 5x + 1, \quad g(x) = x - 2,$$

$$\text{b) } f(x) = x^4 + 4x^3 + x^2 + 18, \quad g(x) = x + 3,$$

$$\text{c) } f(x) = x^5 + 3x^2 + 7, \quad g(x) = x + 1.$$

Solution. a) We need to determine whether 2 is a root of $f(x) = x^3 + 2x^2 + 5x + 1$, that is, whether $f(2)$ is zero.

$$f(2) = 2^3 + 2 \cdot 2^2 + 5 \cdot 2 + 1 = 8 + 8 + 10 + 1 = 27.$$

Here, the first term $5x^2$ of the quotient is just copied from the first term of the dividend. We record this together with the coefficients of the dividend $5x^3 + 7x^2 + x + 4$ and of the divisor $x + 2 = x - (-2)$ as follows:

$$\begin{array}{r|rrrr} -2 & 5 & 7 & 1 & 4 \\ & 5 & & & \\ \hline & & & & \end{array} \quad \begin{array}{l} \text{(dividend } (5x^3 + 7x^2 + x + 4)) \\ \text{(divisor } (x - (-2))) \\ \text{(quotient)} \end{array}$$

The first actual calculation is performed when multiplying the $5x^2$ term with 2, and subtracting it from $7x^2$. We record this as follows.

$$\begin{array}{r|rrrr} -2 & 5 & 7 & 1 & 4 \\ & & -10 & & \\ \hline & 5 & -3 & & \end{array} \quad \begin{array}{l} (-10 \text{ is the product of } -2 \cdot 5) \\ (-3 \text{ is the sum } 7 + (-10)) \end{array}$$

Similarly, we obtain the next step by multiplying the $2x$ by (-3) and subtracting it from $1x$. Therefore, we get

$$\begin{array}{r|rrrr} -2 & 5 & 7 & 1 & 4 \\ & & -10 & 6 & \\ \hline & 5 & -3 & 7 & \end{array} \quad \begin{array}{l} (6 \text{ is the product of } -2 \cdot (-3)) \\ (7 \text{ is the sum } 1 + (6)) \end{array}$$

The last step multiplies 7 times 2 and subtracts this from 4. In short, we write:

$$\begin{array}{r|rrrr} -2 & 5 & 7 & 1 & 4 \\ & & -10 & 6 & -14 \\ \hline & 5 & -3 & 7 & -10 \end{array} \quad \begin{array}{l} (-14 \text{ is the product of } -2 \cdot (7)) \\ (-10 \text{ is the sum } 4 + (-14)) \end{array}$$

The answer can be determined from these coefficients. The quotient is $5x^2 - 3x + 7$, and the remainder is -10 .

Example 8.15. Find the following quotients via synthetic division.

$$\text{a) } \frac{4x^3 - 7x^2 + 4x - 8}{x - 4}, \quad \text{b) } \frac{x^4 - x^2 + 5}{x + 3}.$$

Solution. a) We need to perform the synthetic division.

$$\begin{array}{r|rrrr} 4 & 4 & -7 & 4 & -8 \\ & & 16 & 36 & 160 \\ \hline & 4 & 9 & 40 & 152 \end{array}$$

Therefore we have

$$\frac{4x^3 - 7x^2 + 4x - 8}{x - 4} = 4x^2 + 9x + 40 + \frac{152}{x - 4}.$$

Similarly, we calculate part (b). Note that some of the coefficients are now zero.

$$-3 \left| \begin{array}{ccccc} 1 & 0 & -1 & 0 & 5 \\ & -3 & 9 & -24 & 72 \\ \hline 1 & -3 & 8 & -24 & 77 \end{array} \right.$$

We obtain the following result.

$$\frac{x^4 - x^2 + 5}{x + 3} = x^3 - 3x^2 + 8x - 24 + \frac{77}{x + 5}$$

□

Note 8.16. Synthetic division only works when dividing by a polynomial of the form $x - c$. Do not attempt to use this method to divide by other forms like $x^2 + 2$.

8.4 Exercises

Exercise 8.1. Divide by long division.

$$\begin{array}{lll} \text{a) } \frac{x^3 - 4x^2 + 2x + 1}{x - 2}, & \text{b) } \frac{x^3 + 6x^2 + 7x - 2}{x + 3}, & \text{c) } \frac{x^2 + 7x - 4}{x + 1}, \\ \text{d) } \frac{x^3 + 3x^2 + 2x + 5}{x + 2}, & \text{e) } \frac{2x^3 + x^2 + 3x + 5}{x - 1}, & \text{f) } \frac{2x^4 + 7x^3 + x + 3}{x + 5}, \\ \text{g) } \frac{2x^4 - 31x^2 - 13}{x - 4}, & \text{h) } \frac{x^3 + 27}{x + 3}, & \text{i) } \frac{3x^4 + 7x^3 + 5x^2 + 7x + 4}{3x + 1}, \\ \text{j) } \frac{8x^3 + 18x^2 + 21x + 18}{2x + 3}, & \text{k) } \frac{x^3 + 3x^2 - 4x - 5}{x^2 + 2x + 1}, & \text{l) } \frac{x^5 + 3x^4 - 20}{x^2 + 3}. \end{array}$$

Exercise 8.2. Find the remainder when dividing $f(x)$ by $g(x)$.

$$\begin{array}{ll} \text{a) } f(x) = x^3 + 2x^2 + x - 3, & g(x) = x - 2, \\ \text{b) } f(x) = x^3 - 5x + 8, & g(x) = x - 3, \\ \text{c) } f(x) = x^5 - 1, & g(x) = x + 1, \\ \text{d) } f(x) = x^5 + 5x^2 - 7x + 10, & g(x) = x + 2. \end{array}$$

Exercise 8.3. Determine whether the given $g(x)$ is a factor of $f(x)$. If so, name the corresponding root of $f(x)$.

$$\begin{array}{ll} \text{a) } f(x) = x^2 + 5x + 6, & g(x) = x + 3, \\ \text{b) } f(x) = x^3 - x^2 - 3x + 8, & g(x) = x - 4, \\ \text{c) } f(x) = x^4 + 7x^3 + 3x^2 + 29x + 56, & g(x) = x + 7, \\ \text{d) } f(x) = x^{999} + 1, & g(x) = x + 1. \end{array}$$

Exercise 8.4. Check that the given numbers for x are roots of $f(x)$ (see Observation 8.10). If the numbers x are indeed roots, then use this information to factor $f(x)$ as much as possible.

$$\begin{array}{ll} \text{a) } f(x) = x^3 - 2x^2 - x + 2, & x = 1, \\ \text{b) } f(x) = x^3 - 6x^2 + 11x - 6, & x = 1, x = 2, x = 3, \\ \text{c) } f(x) = x^3 - 3x^2 + x - 3, & x = 3, \\ \text{d) } f(x) = x^3 + 6x^2 + 12x + 8, & x = -2, \\ \text{e) } f(x) = x^3 + 13x^2 + 50x + 56, & x = -3, x = -4, \\ \text{f) } f(x) = x^3 + 3x^2 - 16x - 48, & x = 2, x = -4, \\ \text{g) } f(x) = x^5 + 5x^4 - 5x^3 - 25x^2 + 4x + 20, & x = 1, x = -1, \\ & x = 2, x = -2. \end{array}$$

Exercise 8.5. Divide by using synthetic division.

$$\begin{array}{lll} \text{a) } \frac{2x^3+3x^2-5x+7}{x-2}, & \text{b) } \frac{4x^3+3x^2-15x+18}{x+3}, & \text{c) } \frac{x^3+4x^2-3x+1}{x+2}, \\ \text{d) } \frac{x^4+x^3+1}{x-1}, & \text{e) } \frac{x^5+32}{x+2}, & \text{f) } \frac{x^3+5x^2-3x-10}{x+5}. \end{array}$$

Session 9

Graphing polynomials

9.1 Graphs of polynomials

We now discuss the shape of the graphs of polynomial functions. Recall that a polynomial function f of degree n is a function of the form

$$f(x) = a_n x^n + a_{n-1} x^{n-1} + \cdots + a_2 x^2 + a_1 x + a_0.$$

Observation 9.1. We already know from Section 2.1, that the graphs of polynomials $f(x) = ax + b$ of degree 1 are straight lines.

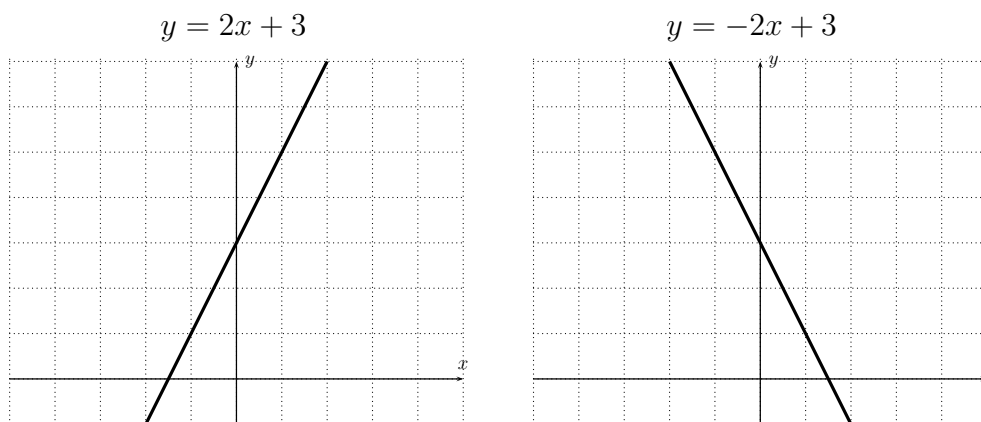

Polynomials of degree 1 have only one root.

It is also easy to sketch the graphs of functions $f(x) = x^n$.

Observation 9.2. Graphing $y = x^2$, $y = x^3$, $y = x^4$, $y = x^5$, we obtain:

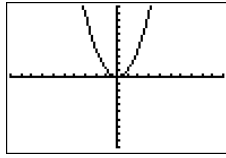

$$y = x^2$$

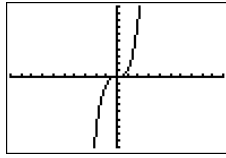

$$y = x^3$$

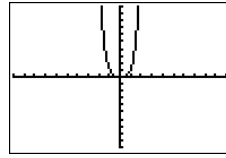

$$y = x^4$$

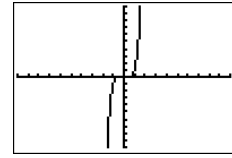

$$y = x^5$$

From this, we see that the shape of the graph of $f(x) = x^n$ depends on n being even or odd.

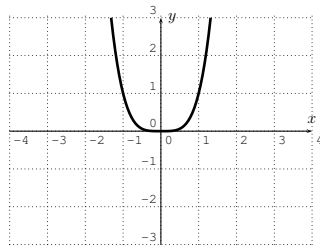

$y = x^n$, for n even
If x approaches $\pm\infty$,
 $\Rightarrow y$ approaches $+\infty$.

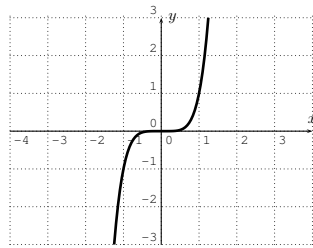

$y = x^n$, for n odd
If x approaches $\pm\infty$,
 $\Rightarrow y$ approaches $\pm\infty$.

We now make some observations about graphs of general polynomials of degrees 2, 3, 4, 5, and, more generally, of any degree n . In particular, we will be interested in the number of roots and the number of extrema (that is the number of maxima or a minima) of the graph of a polynomial f .

Observation 9.3. Let $f(x) = ax^2 + bx + c$ be a polynomial of degree 2. The graph of f is a parabola.

- f has at most 2 roots. f has one extremum (that is one maximum or minimum).

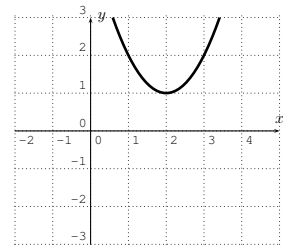
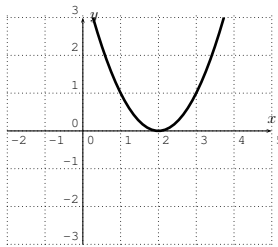
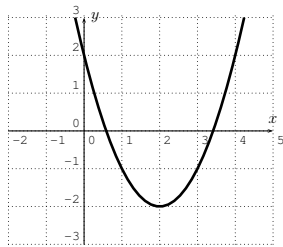

- If $a > 0$ then f opens upwards, if $a < 0$ then f opens downwards.

$$y = x^2 - 4x + 2$$

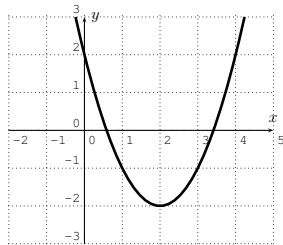

$$y = -x^2 + 4x - 2$$

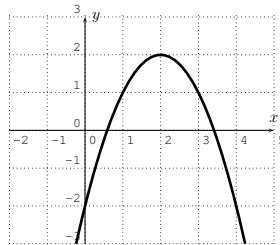

Observation 9.4. Let $f(x) = ax^3 + bx^2 + cx + d$ be a polynomial of degree 3. The graph may change its direction at most twice.

- f has at most 3 roots. f has at most 2 extrema.

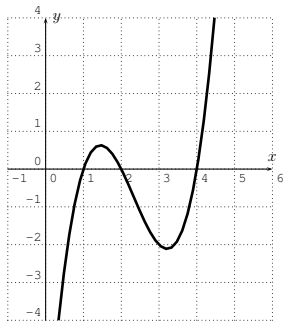

3 roots, 2 extrema

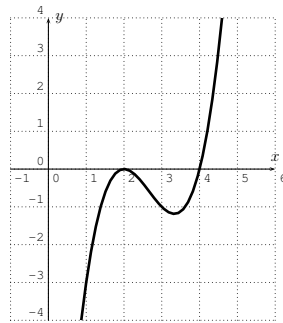

2 roots, 2 extrema

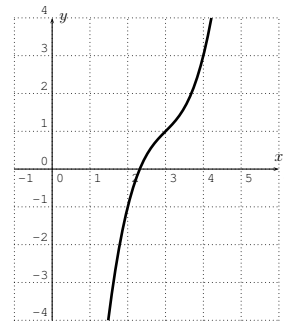

1 root, 0 extrema

- If $a > 0$ then $f(x)$ approaches $+\infty$ when x approaches $+\infty$ (that is, $f(x)$ gets large when x gets large), and $f(x)$ approaches $-\infty$ when x approaches $-\infty$. If $a < 0$ then $f(x)$ approaches $-\infty$ when x approaches $+\infty$, and $f(x)$ approaches $+\infty$ when x approaches $-\infty$.

$$y = x^3 - 6x^2 + 11x - 4$$

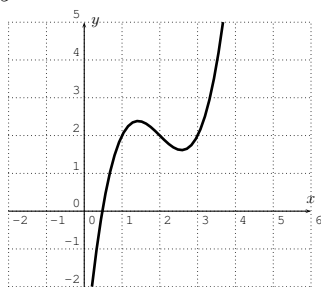

$$y = -x^3 + 6x^2 - 11x + 7$$



Above, we have a first instance of a polynomial of degree n which “changes its direction” one more time than a polynomial of one lesser degree $n - 1$. Below, we give examples of this phenomenon for higher degrees as well.

Observation 9.5. Let $f(x) = ax^4 + bx^3 + cx^2 + dx + e$ be a polynomial of degree 4.

- f has at most 4 roots. f has at most 3 extrema. If $a > 0$ then f opens upwards, if $a < 0$ then f opens downwards.

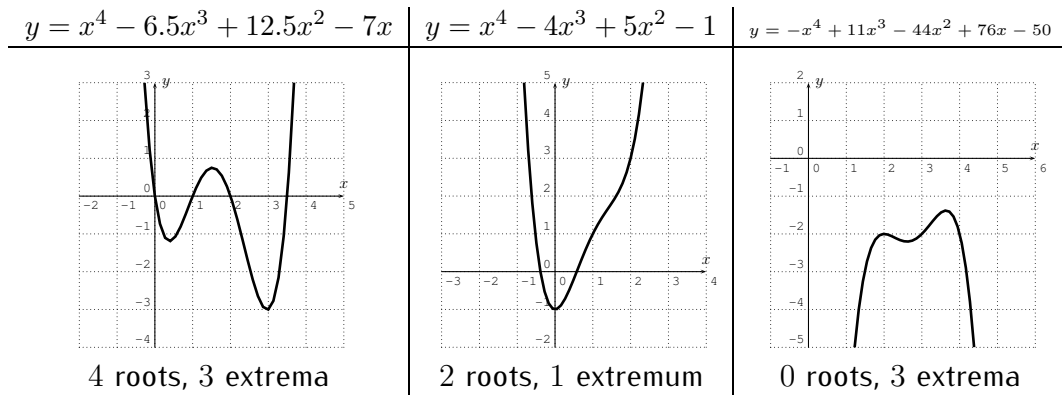

Observation 9.6. Let f be a polynomial of degree 5.

- f has at most 5 roots. f has at most 4 extrema. If $a > 0$ then $f(x)$ approaches $+\infty$ when x approaches $+\infty$, and $f(x)$ approaches $-\infty$ when x approaches $-\infty$. If $a < 0$ then $f(x)$ approaches $-\infty$ when x approaches $+\infty$, and $f(x)$ approaches $+\infty$ when x approaches $-\infty$.

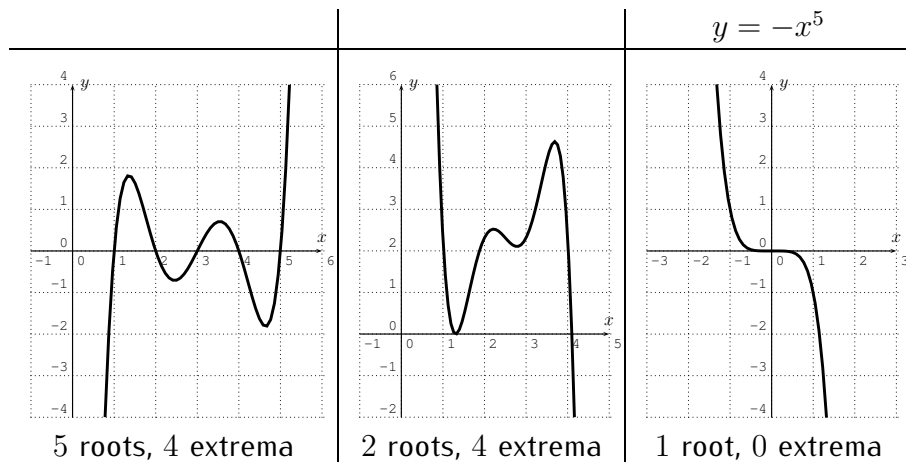

Observation 9.7.

- Let $f(x) = a_n x^n + a_{n-1} x^{n-1} + \cdots + a_2 x^2 + a_1 x + a_0$ be a polynomial of degree n . Then f has at most n roots, and at most $n - 1$ extrema.

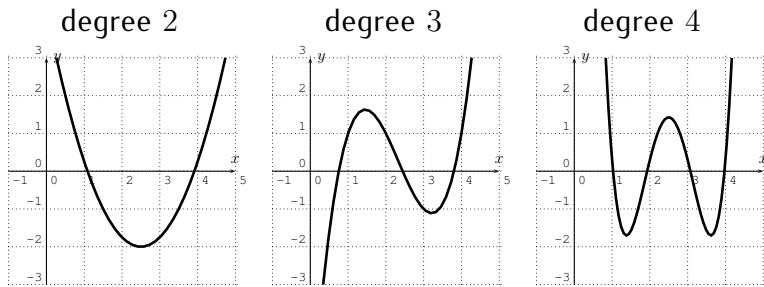

- Assume the degree of f is even $n = 2, 4, 6, \dots$. If $a_n > 0$, then the polynomial opens upwards. If $a_n < 0$ then the polynomial opens downwards.

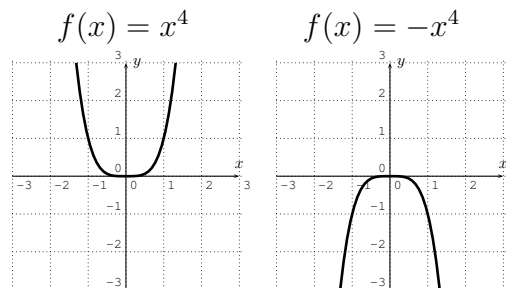

- Assume the degree of f is odd, $n = 1, 3, 5, \dots$. If $a_n > 0$, then $f(x)$ approaches $+\infty$ when x approaches $+\infty$, and $f(x)$ approaches $-\infty$ as x approaches $-\infty$. If $a_n < 0$, then $f(x)$ approaches $-\infty$ when x approaches $+\infty$, and $f(x)$ approaches $+\infty$ as x approaches $-\infty$.

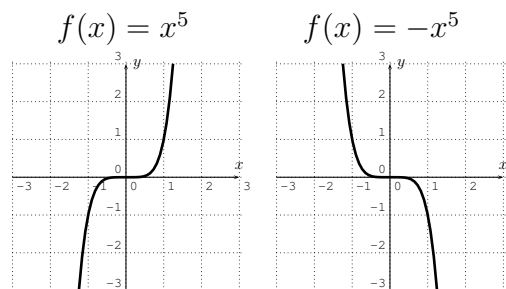

- The domain of a polynomial f is all real numbers, and f is continuous for all real numbers (there are no jumps in the graph). The graph of f has no horizontal or vertical asymptotes, no discontinuities (jumps in the graph), and no corners. Furthermore, $f(x)$ approaches $\pm\infty$ when x approaches $\pm\infty$. Therefore, the following graphs **cannot** be graphs of polynomials.

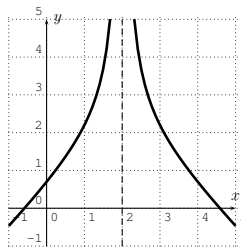

vertical asymptote / pole

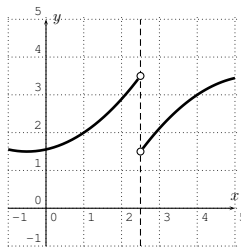

discontinuity

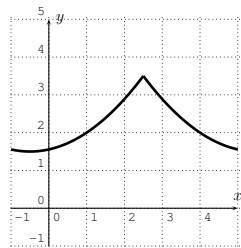

corner

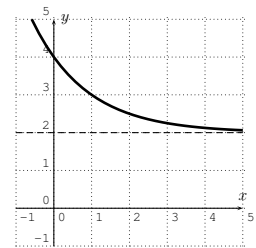

horizontal asymptote

Example 9.8. Which of the following graphs could be the graphs of a polynomial? If the graph could indeed be a graph of a polynomial then determine a possible degree of the polynomial.

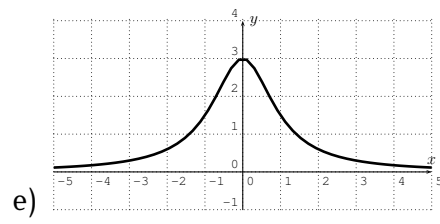
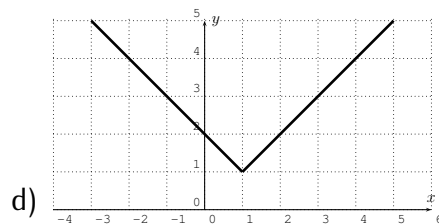
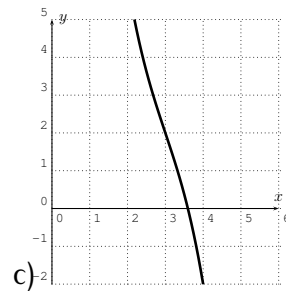
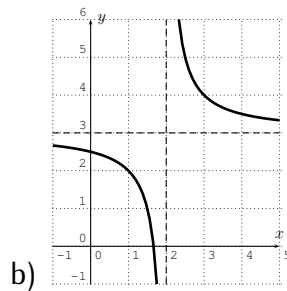
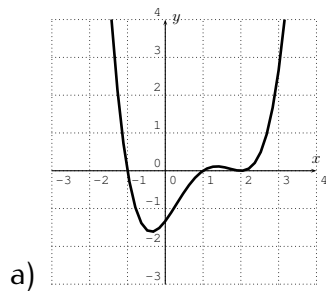

Solution.

- a) Yes, this could be a polynomial. The degree could be, for example, 4.
 b) No, since the graph has a pole.
 c) Yes, this could be a polynomial. A possible degree would be degree 3.
 d) No, since the graph has a corner.
 e) No, since $f(x)$ does not approach ∞ or $-\infty$ as x approaches ∞ . (In fact $f(x)$ approaches 0 as x approaches $\pm\infty$ and we say that the function (or graph) has a horizontal asymptote $y = 0$.)

□

Example 9.9. Identify the graphs of the polynomials in (a), (b) and (c) with the functions (i), (ii), and (iii).

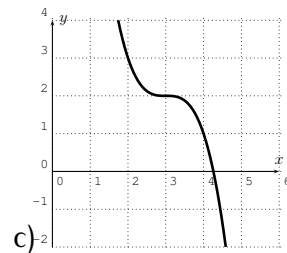
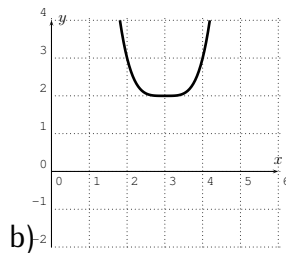
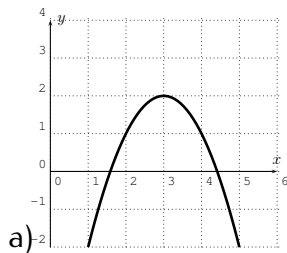

- i) $f(x) = -x^3 + 9x^2 - 27x + 29$
 ii) $f(x) = -x^2 + 6x - 7$
 iii) $f(x) = x^4 - 12x^3 + 54x^2 - 108x + 83$

Solution. The only odd degree function is (i) and it must therefore correspond to graph (c). For (ii), since the leading coefficient is negative, we know that the function opens downwards, so that it corresponds to graph (a). Finally (iii) opens upwards, since the leading coefficient is positive, so that its graph is (b). □

When graphing a function, we need to make sure to draw the function in a window that expresses all the interesting features of the graph. More precisely, we need to make sure that the graph includes all essential parts of the graph, such as all *intercepts* (both x -intercepts and y -intercept), all *roots*, all *asymptotes* (this will be discussed in the next part), and the *long range behavior* of the function (that is how the function behaves when x approaches $\pm\infty$). We also want to include all *extrema* (that is all maxima and minima) of the function.

Example 9.10. Graph of the given function with the TI-84. Include all extrema and intercepts of the graph in your viewing window.

- a) $f(x) = -x^3 + 26x^2 - 129x + 175$
 b) $f(x) = .1x^4 - 2.4x^2 + 6.4x - 35$
 c) $f(x) = -5x^3 + 75x^2 - 374.998x + 630$
 d) $f(x) = -.01x^4 + .4x^3 + .0025x^2 - 160x + 1600$

Solution. a) The graph in the standard window looks as follows:

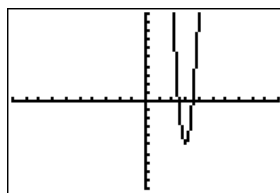

However, since the function is of degree 3, this cannot be the full graph, as $f(x)$ has to approach $-\infty$ when x approaches ∞ . Zooming out, and rescaling appropriately for the following setting the following graph.

```

WINDOW
Xmin=-5
Xmax=25
Xscl=1
Ymin=-100
Ymax=1000
Yscl=1
↓Xres=1
  
```

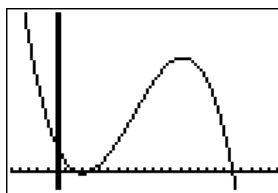

b) The graph in the standard window is drawn on the left below. After rescaling to $-10 \leq x \leq 10$ and $-100 \leq y \leq 30$ we obtain the graph on the right.

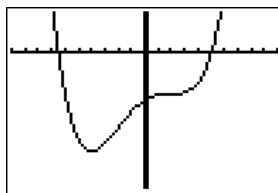
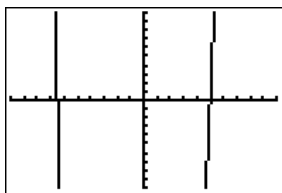

c) The graph in the standard window is drawn on the left. Zooming to the interesting part of the graph, we obtain the graph on the right. (Below, we

have chosen a window of $4.94 \leq x \leq 5.06$ and $5.00995 \leq y \leq 5.01005$.)

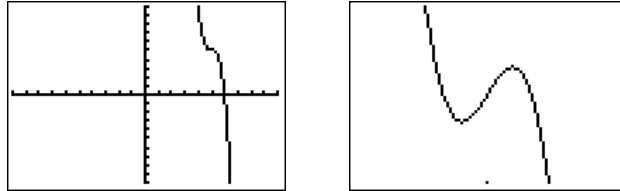

d) The standard window (see left graph) shows an empty coordinate system without any part of the graph. However, zooming out to $-30 \leq x \leq 40$ and $-1000 \leq y \leq 4000$, we obtain the middle graph. There is another interesting part of the graph displayed on the right, coming from zooming to the plateau on the right (here shown at $19.2 \leq x \leq 20.8$ and $0.9 \leq y \leq 1.1$).

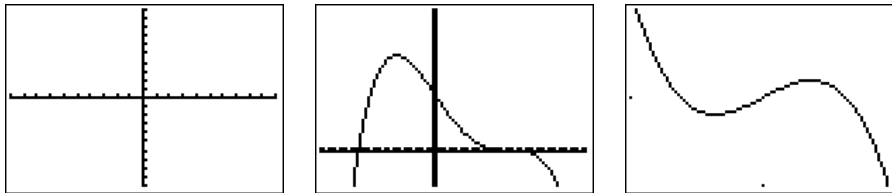

□

9.2 Finding roots of a polynomial with the TI-84

We have seen that the roots are important features of a polynomial. Recall that the roots of the polynomial f are those x_0 for which $f(x_0) = 0$. These are, of course, precisely the x -intercepts of the graph. Therefore we may use the graph of a polynomial for finding its roots as we did in section 4.

Example 9.11. Find the roots of the polynomial from its graph.

a) $f(x) = x^3 - 7x^2 + 14x - 8$, b) $f(x) = -x^3 + 8x^2 - 21x + 18$,

c) $f(x) = x^4 + 3x^3 - x + 6$, d) $f(x) = x^5 - 3x^4 - 8x^3 + 24x^2 + 15x - 45$.

Solution. a) We start by graphing the polynomial $f(x) = x^3 - 7x^2 + 14x - 8$.

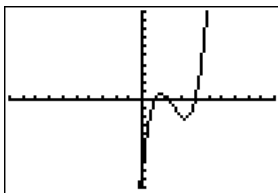

The graph suggests that the roots are at $x = 1$, $x = 2$, and $x = 4$. This may easily be checked by looking at the function table.

X	Y1	
0	-8	
1	0	
2	0	
3	-2	
4	0	
5	12	
6	40	

X=0

Since the polynomial is of degree 3, there cannot be any other roots.

b) Graphing $f(x) = -x^3 + 8x^2 - 21x + 18$ with the calculator shows the following display.

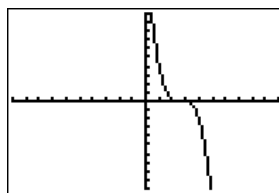

Zooming into the graph reveals that there are in fact two roots, $x = 2$ and $x = 3$, which can be confirmed from the table.

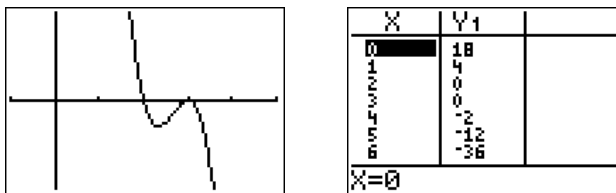

Note, that the root $x = 3$ only “touches” the x -axis. This is due to the fact that $x = 3$ appears as a *multiple* root. Indeed, since 3 is a root, we can divide $f(x)$ by $x - 3$ without remainder and factor the resulting quotient to see that

$$f(x) = (x - 2)(x - 3)(x - 3) = (x - 2)(x - 3)^2.$$

We say that $x = 3$ is a root of *multiplicity 2*.

c) The graph of $f(x) = x^4 + 3x^3 - x + 6$ in the standard window is displayed as follows.

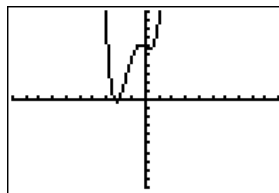

Since this is a polynomial of degree 4, all of the essential features are already displayed in the above graph. The roots can be seen by zooming into the graph.

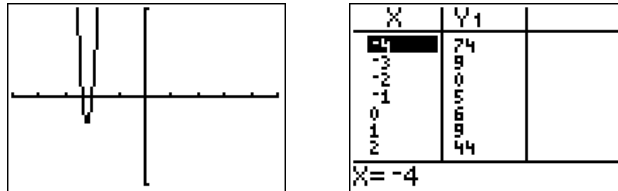

From the table and the graph we see that there is a root at $x = -2$ and another root at between -3 and -2 . Finding the exact value of this second root can be quite difficult, and we will say more about this in section 10.2 below. At this point, we can only approximate the root with the “zero” function from the “calc” menu:

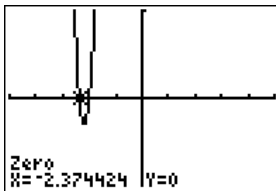

d) The graph of $f(x) = x^5 - 3x^4 - 8x^3 + 24x^2 + 15x - 45$ in the standard window is displayed below.

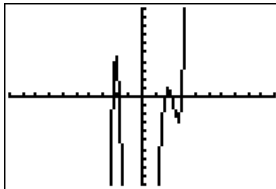

Zooming into the x -axis, and checking the table shows that the only obvious root is $x = 3$.

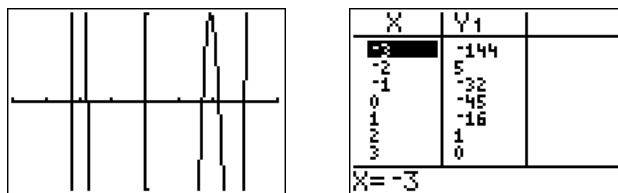

The other four roots are more difficult to find. However they can be approximated using the “zero” function from the “calc” menu. \square

It will often be necessary to find the roots of a quadratic polynomial. For this reason, we recall the well-known quadratic formula.

Theorem 9.12 (The quadratic formula).

The solutions of the equation $ax^2 + bx + c = 0$ for some real numbers a , b , and c are given by

$$x_1 = \frac{-b + \sqrt{b^2 - 4ac}}{2a}, \text{ and } x_2 = \frac{-b - \sqrt{b^2 - 4ac}}{2a}.$$

We may combine the two solutions x_1 and x_2 and simply write this as:

$$x_{1/2} = \frac{-b \pm \sqrt{b^2 - 4ac}}{2a}$$

Note 9.13. We may always use the roots x_1 and x_2 of a quadratic polynomial $f(x) = ax^2 + bx + c$ from the quadratic formula and rewrite the polynomial as

$$f(x) = ax^2 + bx + c = a \cdot \left(x - \frac{-b + \sqrt{b^2 - 4ac}}{2a}\right) \left(x - \frac{-b - \sqrt{b^2 - 4ac}}{2a}\right).$$

9.3 *Optional section:* Graphing polynomials by hand

In this section we will show how to sketch the graph of a factored polynomial without the use of a calculator.

Example 9.14. Sketch the graph of the following polynomial without using the calculator:

$$p(x) = -2(x + 10)^3(x + 9)x^2(x - 8)$$

Solution. Note, that on the calculator it is impossible to get a window which will give all of the features of the graph (while focusing on getting the maximum in view the other features become invisible). We will sketch the graph by hand so that some of the main features are visible. This will only be a sketch and not the actual graph up to scale. Again, the graph can not be drawn to scale while being able to see the features.

We first start by putting the x -intercepts on the graph in the right order, but not to scale necessarily. Then note that

$$p(x) = -2x^7 + \dots (\text{lower terms}) \approx -2x^7 \quad \text{for large } |x|.$$

9.3. OPTIONAL SECTION: GRAPHING POLYNOMIALS BY HAND 125

This is the leading term of the polynomial (if you expand p it is the term with the largest power) and therefore dominates the polynomial for large $|x|$. So the graph of our polynomial should look something like the graph of $y = -2x^7$ on the extreme left and right side.

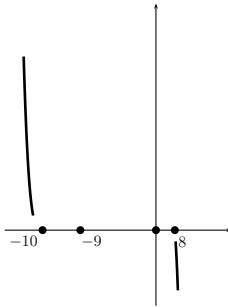

Now we look at what is going on at the roots. Near each root the factor corresponding to that root dominates. So we have

for $x \approx$	$p(x) \approx$	
-10	$C_1(x + 10)^3$	cubic
-9	$C_2(x + 9)$	line
0	$C_3 x^2$	parabola
8	$C_4(x - 8)$	line

where $C_1, C_2, C_3,$ and C_4 are constants which can, but need not, be calculated. For example, whether or not the parabola near 0 opens up or down will depend on whether the constant $C_3 = -2 \cdot (0+10)^3(0+9)(0-8)$ is negative or positive. In this case C_3 is positive so it opens upward but we will not use this fact to graph. We will see this independently which is a good check on our work.

Starting from the left of our graph where we had determined the behavior for large negative x , we move toward the left most zero, -10 . Near -10 the graph looks cubic so we imitate a cubic curve as we pass through $(-10, 0)$.

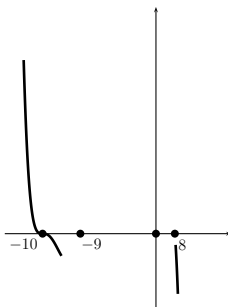

Now we turn and head toward the next zero, -9 . Here the graph looks like a line, so we pass through the point $(-9, 0)$ as a line would.

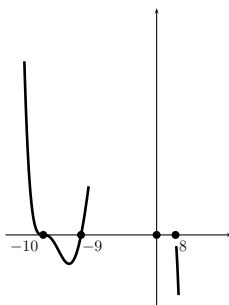

Now we turn and head toward the root 0. Here the graph should look like a parabola. So we form a parabola there. (Note that as we had said before the parabola should be opening upward here—and we see that it is).

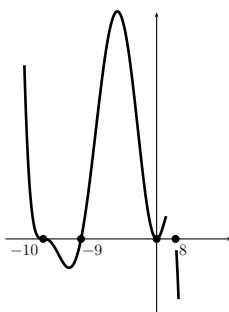

Now we turn toward the final zero 8. We pass through the point $(8, 0)$ like a line and we join (perhaps with the use of an eraser) to the large x part of the graph. If this doesn't join nicely (if the graph is going in the wrong direction) then there has been a mistake. This is a check on your work. Here is the final sketch.

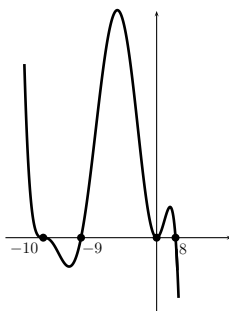

What can be understood from this sketch? Questions like 'when is $p(x) > 0$?' can be answered by looking at the sketch. Further, the general shape of the curve is correct so other properties can be concluded. For example, p has a local minimum between $x = -10$ and $x = -9$ and a local maximum between $x = -9$ and $x = 0$, and between $x = 0$ and $x = 8$. The exact point where the function reaches its maximum or minimum can not be decided by looking at this sketch. But it will help to decide on an appropriate window so that the minimum or maximum finder on the calculator can be used. \square

9.4 Exercises

Exercise 9.1. Which of the graphs below could be the graphs of a polynomial?

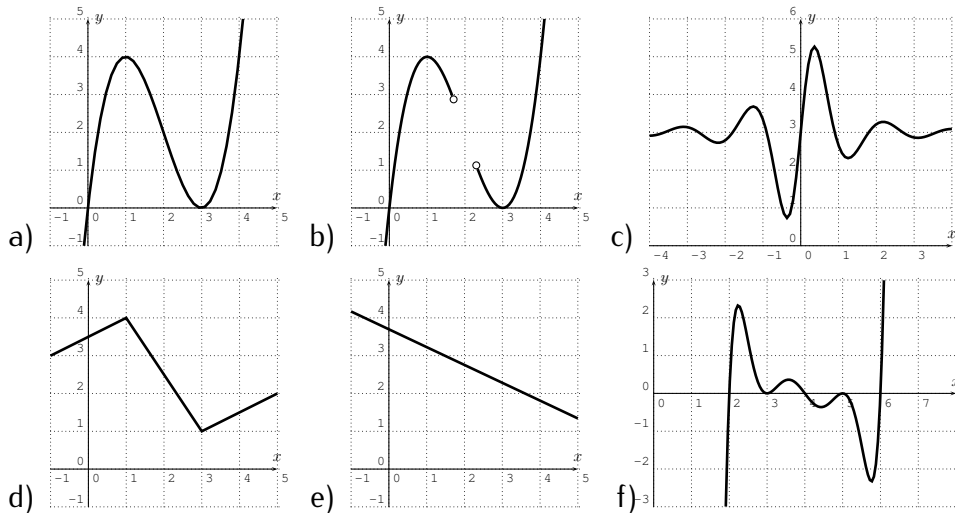

Exercise 9.2. Identify each of the graphs (a)-(e) with its corresponding assignment from (i)-(vi) below.

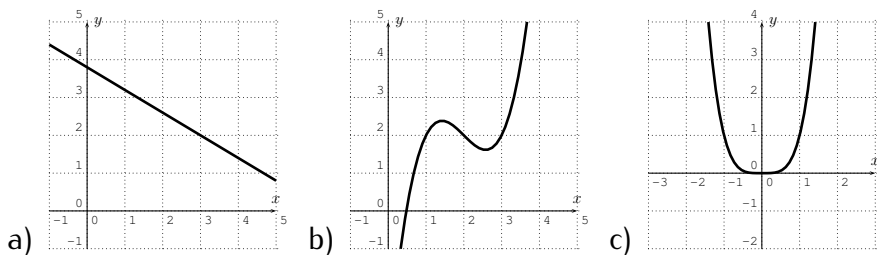

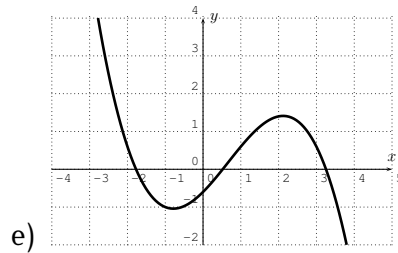
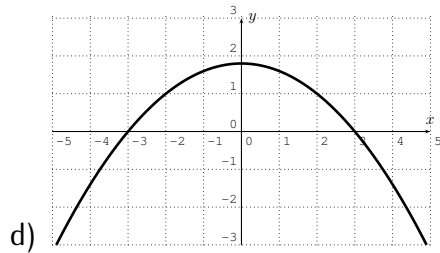

d)

e)

- i) $f(x) = -x^2$
- ii) $f(x) = -0.2x^2 + 1.8$
- iii) $f(x) = -0.6x + 3.8$
- iv) $f(x) = -0.2x^3 + 0.4x^2 + x - 0.6$
- v) $f(x) = x^3 - 6x^2 + 11x - 4$
- vi) $f(x) = x^4$

Exercise 9.3. Identify the graph with its assignment below.

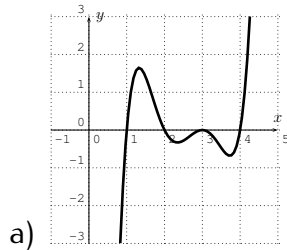

a)

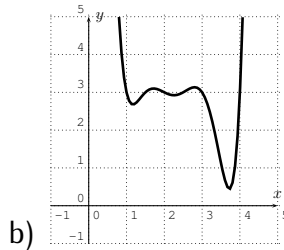

b)

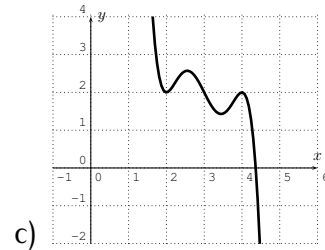

c)

- i) $f(x) = x^6 - 14x^5 + 78.76x^4 - 227.5x^3 + 355.25x^2 - 283.5x + 93$
- ii) $f(x) = -2x^5 + 30x^4 - 176x^3 + 504x^2 - 704x + 386$
- iii) $f(x) = x^5 - 13x^4 + 65x^3 - 155x^2 + 174x - 72$

Exercise 9.4. Sketch the graph of the function with the TI-84, which includes all extrema and intercepts of the graph.

- a) $f(x) = 0.002x^3 + 0.2x^2 - 0.05x - 5$
- b) $f(x) = x^3 + 4x + 50$
- c) $f(x) = 0.01x^4 - 0.101x^3 - 3x^2 + 50.3x$
- d) $f(x) = x^3 - .007x$
- e) $f(x) = x^3 + .007x$
- f) $f(x) = 0.025x^4 + 0.0975x^3 - 1.215x^2 + 2.89x - 22$

Exercise 9.5. Find the exact value of at least one root of the given polynomial.

a) $f(x) = x^3 - 10x^2 + 31x - 30,$

b) $f(x) = -x^3 - x^2 + 8x + 8,$

c) $f(x) = x^3 - 11x^2 - 3x + 33,$

d) $f(x) = x^4 + 9x^3 - 6x^2 - 136x - 192,$

e) $f(x) = x^2 + 6x + 3,$

f) $f(x) = x^4 - 6x^3 + 3x^2 + 5x.$

Exercise 9.6. Graph the following polynomials without using the calculator.

a) $f(x) = (x + 4)^2(x - 5),$

b) $f(x) = -3(x + 2)^3x^2(x - 4)^5,$

c) $f(x) = 2(x - 3)^2(x - 5)^3(x - 7),$

d) $f(x) = -(x + 4)(x + 3)(x + 2)^2(x + 1)(x - 2)^2.$

Session 10

Roots of polynomials

10.1 *Optional section:* The rational root theorem

Example 10.1. Consider the equation $10x^3 - 6x^2 + 5x - 3 = 0$. Let x be a rational solution of this equation, that is $x = \frac{p}{q}$ is a rational number such that

$$10 \cdot \left(\frac{p}{q}\right)^3 - 6 \cdot \left(\frac{p}{q}\right)^2 + 5 \cdot \frac{p}{q} - 3 = 0.$$

We assume that $x = \frac{p}{q}$ is *completely reduced*, that is, p and q have no common factors that can be used to cancel the numerator and denominator of the fraction $\frac{p}{q}$. Now, simplifying the above equation, and combining terms, we obtain:

$$\begin{aligned} & 10 \cdot \frac{p^3}{q^3} - 6 \cdot \frac{p^2}{q^2} + 5 \cdot \frac{p}{q} - 3 = 0 \\ \text{(multiply by } q^3) & \implies 10p^3 - 6p^2q + 5pq^2 - 3q^3 = 0 \\ \text{(add } 3q^3) & \implies 10p^3 - 6p^2q + 5pq^2 = 3q^3 \\ \text{(factor } p \text{ on the left)} & \implies p \cdot (10p^2 - 6pq + 5q^2) = 3q^3. \end{aligned}$$

Therefore, p is a factor of $3q^3$ (with the other factor being $(10p^2 - 6pq + 5q^2)$). Since p and q have no common factors, p must be a factor of 3. That is, p is one of the following integers: $p = +1, +3, -1, -3$.

Similarly starting from $10p^3 - 6p^2q + 5pq^2 - 3q^3 = 0$, we can write

$$\text{(add } +6p^2q - 5pq^2 + 3q^3) \implies 10p^3 = 6p^2q - 5pq^2 + 3q^3$$

$$(\text{factor } q \text{ on the right}) \implies 10p^3 = (6p^2 - 5pq + 3q^2) \cdot q.$$

Now, q must be a factor of $10p^3$. Since q and p have no common factors, q must be a factor of 10. In other words, q is one of the following numbers: $q = \pm 1, \pm 2, \pm 5, \pm 10$. Putting this together with the possibilities for $p = \pm 1, \pm 3$, we see that all possible rational roots are the following:

$$\pm \frac{1}{1}, \pm \frac{1}{2}, \pm \frac{1}{5}, \pm \frac{1}{10}, \pm \frac{3}{1}, \pm \frac{3}{2}, \pm \frac{3}{5}, \pm \frac{3}{10}.$$

The observation in the previous example holds for a general polynomial equation with integer coefficients.

Observation 10.2 (Rational root theorem). Consider the equation

$$a_n x^n + a_{n-1} x^{n-1} + \dots + a_1 x + a_0 = 0, \tag{10.1}$$

where every coefficient a_n, a_{n-1}, \dots, a_0 is an integer and $a_0 \neq 0, a_n \neq 0$. Assume that $x = \frac{p}{q}$ is a solution of (10.1) and the fraction $x = \frac{p}{q}$ is completely reduced. Then $a_0 p$ is an integer multiple of q , and $a_n q$ is an integer multiple of p .

Therefore, all possible rational solutions of (10.1) are fractions $x = \frac{p}{q}$ where p is a factor of a_0 and q is a factor of a_n .

We can use this observation to find good candidates for the roots of a given polynomial.

Example 10.3.

- a) Find all *rational* roots of $f(x) = 7x^3 + x^2 + 7x + 1$.
- b) Find all *real* roots of $f(x) = 2x^3 + 11x^2 - 2x - 2$.
- c) Find all *real* roots of $f(x) = 4x^4 - 23x^3 - 2x^2 - 23x - 6$.

Solution. a) If $x = \frac{p}{q}$ is a rational root, then p is a factor of 1, that is $p = \pm 1$, and q is a factor of 7, that is $q = \pm 1, \pm 7$. The candidates for rational roots are therefore $x = \pm \frac{1}{1}, \pm \frac{1}{7}$. To see which of these candidates are indeed roots of f we plug these numbers into f via the calculator. We obtain the following:

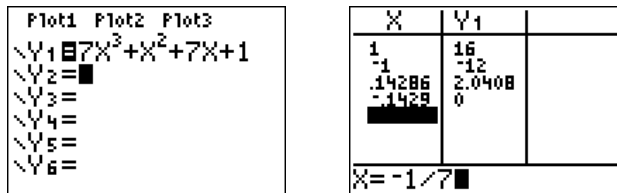

that $x^2 + 6x + 2$ has no other rational roots. Nevertheless, we can identify all other real roots of $x^2 + 6x + 2$ via the quadratic formula, (see Theorem 9.12 below).

$$\begin{aligned} x^2 + 6x + 2 = 0 \quad \implies \quad x_{1/2} &= \frac{-6 \pm \sqrt{6^2 - 4 \cdot 1 \cdot 2}}{2} \\ &= \frac{-6 \pm \sqrt{36 - 8}}{2} = \frac{-6 \pm \sqrt{28}}{2} \\ &= \frac{-6 \pm \sqrt{4 \cdot 7}}{2} = \frac{-6 \pm 2\sqrt{7}}{2} \\ &= -3 \pm \sqrt{7} \end{aligned}$$

Therefore, the roots of f are precisely the following

$$x_1 = -3 + \sqrt{7}, \quad x_2 = -3 - \sqrt{7}, \quad x_3 = \frac{1}{2}.$$

c) First we find the rational roots $x = \frac{p}{q}$ of $f(x) = 4x^4 - 23x^3 - 2x^2 - 23x - 6$. Since p is a factor of -6 it must be $p = \pm 1, \pm 2, \pm 3, \pm 6$, and since q is a factor of 4 it must be $q = \pm 1, \pm 2, \pm 4$. All candidates for rational roots $x = \frac{p}{q}$ are the following (where we excluded repeated ways of writing x):

$$\pm 1, \quad \pm 2, \quad \pm 3, \quad \pm 6, \quad \pm \frac{1}{2}, \quad \pm \frac{3}{2}, \quad \pm \frac{1}{4}, \quad \pm \frac{3}{4}$$

Checking all these candidates with the calculator produces exactly two rational roots: $x = 6$ and $x = -\frac{1}{4}$. Therefore, we may divide $f(x)$ by both $(x - 6)$ and by $(x + \frac{1}{4})$ without remainder. To avoid fractions, we use the term $4 \cdot (x + \frac{1}{4}) = (4x + 1)$ instead of $(x + \frac{1}{4})$ for our factor of f . Therefore, $f(x) = q(x) \cdot (x - 6) \cdot (4x + 1)$. The quotient $q(x)$ is determined by performing a long division by $(x - 6)$ and then another long division by $(4x + 1)$, or alternatively by only one long division by

$$(x - 6) \cdot (4x + 1) = 4x^2 + x - 24x - 6 = 4x^2 - 23x - 6.$$

Dividing $f(x) = 4x^4 - 23x^3 - 2x^2 - 23x - 6$ by $4x^2 - 23x - 6$ produces the

quotient $q(x)$:

$$4x^2 - 23x - 6 \overline{) \begin{array}{r} x^2 + 1 \\ 4x^4 - 23x^2 - 6 \\ -(4x^4 - 23x^3 - 6x^2) \\ \hline 4x^2 - 23x - 6 \\ -(4x^2 - 23x - 6) \\ \hline 0 \end{array}}$$

We obtain the factored expression for $f(x)$ as $f(x) = (x^2 + 1)(4x + 1)(x - 6)$. The only remaining real roots we need to find are those of $x^2 + 1$. However,

$$x^2 + 1 = 0 \quad \implies \quad x^2 = -1$$

has no real solution. In other words there are only complex solutions of $x^2 = -1$, which are $x = i$ and $x = -i$ (we will discuss complex solutions in more detail in the next section). Since the problem requires us to find the *real* roots of f , our answer is that the only real roots are $x_1 = 6$ and $x_2 = -\frac{1}{4}$. \square

In the above example, we used the quadratic formula 9.12 from page 124.

10.2 The fundamental theorem of algebra

We have seen in Observation 8.10 on page 106 that every root c of a polynomial $f(x)$ gives a factor $(x - c)$ of $f(x)$. There is a theorem which says something about the existence of roots and factors but we will need to discuss complex numbers briefly before stating that theorem.

As stated above, we know that there is no real number that satisfies $x^2 = -1$. So we define i to be a solution to this equation. This i is not a real number but a new kind of number called a *complex* number. We can think of i as $\sqrt{-1}$. We can now consider numbers of the form $a + ib$ where a and b are real numbers. Numbers of this form constitutes the set of complex numbers, denoted by \mathbb{C} . a is called the *real part* and b is called the *imaginary part* of the complex number $a + ib$. We can add two complex numbers by adding their real and imaginary parts to form the real and imaginary parts of the sum. We can multiply two complex numbers by ordinary distribution (FOIL) then use the property that $i^2 = -1$.

Example 10.4. We have

$$(2 - 3i) - (4 + 3i) = (2 - 4) + (-3 - 3)i = -2 - 6i$$

and

$$(2 - 3i)(4 + 3i) = 8 + 6i - 12i - 9i^2 = 8 - 6i - 9(-1) = 17 - 6i.$$

We can see by writing, for example, $\sqrt{-6} = i\sqrt{6}$, that these numbers arise naturally as roots of quadratic equations. But there is more! The following fundamental theorem of algebra guarantees the existence of roots of any polynomial.

Theorem 10.5 (Fundamental theorem of algebra).

Let $f(x) = a_n x^n + a_{n-1} x^{n-1} + \cdots + a_1 x + a_0$ be a non-constant polynomial. Then there exists a complex number c which is a root of f .

Let us make two remarks about the fundamental theorem of algebra to clarify the statement of the theorem.

Note 10.6.

- In the above Theorem 10.5 we did not specify what kind of coefficients a_0, \dots, a_n are allowed for the theorem to hold. In fact, to be precise, the fundamental theorem of algebra states that for any *complex* numbers a_0, \dots, a_n , the polynomial $f(x) = a_n x^n + a_{n-1} x^{n-1} + \cdots + a_1 x + a_0$ has a root.
- In general there may *not* exist a *real* root c of a given polynomial, but the root c may only be a complex number. For example, consider $f(x) = x^2 + 1$, and consider the roots c of f , that is $c^2 + 1 = 0$. Then, for any real number c , we have always $c^2 \geq 0$, so that $f(c) = c^2 + 1 \geq 1$, so that there cannot be a real root c of f . However, if we multiply

$$(x - i)(x + i) = x^2 + xi - xi - i^2 = x^2 + 1,$$

we see that f has *complex* roots $c = i$ and $c = -i$.

Now, while the fundamental theorem of algebra guarantees a root c of a polynomial f , we can use the remainder theorem from Observation 8.10 to check possible candidates c for the roots, and the factor theorem to factor $f(x) = q(x) \cdot (x - c)$.

Therefore, $f(x) = (2x^2 - 2x - 12)(x - 3)$. To factor f completely, we still need to factor the first polynomial $2x^2 - 2x - 12$:

$$\begin{aligned} f(x) &= (2x^2 - 2x - 12)(x - 3) = 2 \cdot (x^2 - x - 6) \cdot (x - 3) \\ &= 2 \cdot (x - 3) \cdot (x + 2) \cdot (x - 3) = 2 \cdot (x + 2) \cdot (x - 3)^2. \end{aligned}$$

b) The graph of $f(x) = x^4 - 3x^3 - 36x^2 + 68x + 240$ in the standard window is the following:

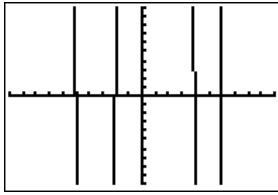

We suspect that $x = -5$, $x = -2$, $x = 4$, and $x = 6$ are the roots of the function. This is confirmed by checking the table on the calculator, and also by direct computation.

X	Y1
-6	480
-5	0
-4	-160
-3	-126
-2	0
-1	140
0	240

X=-5

X	Y1
2	224
3	120
4	0
5	-70
6	0
7	324
8	1040

X=4

$$\begin{aligned} f(-5) &= (-5)^4 - 3(-5)^3 - 36(-5)^2 + 68(-5) + 240 = 0, \\ f(-2) &= (-2)^4 - 3(-2)^3 - 36(-2)^2 + 68(-2) + 240 = 0, \\ f(4) &= 4^4 - 3 \cdot 4^3 - 36 \cdot 4^2 + 68 \cdot 4 + 240 = 0, \\ f(6) &= 6^4 - 3 \cdot 6^3 - 36 \cdot 6^2 + 68 \cdot 6 + 240 = 0. \end{aligned}$$

Therefore, each $(x+5)$, $(x+2)$, $(x-4)$, and $(x-6)$ is a factor of $f(x)$, and then their product is also a factor of $f(x)$. The product $(x+5)(x+2)(x-4)(x-6)$ is calculated as follows. Since $(x+5)(x+2) = x^2 + 7x + 10$ and $(x-4)(x-6) = x^2 - 10x + 24$, we obtain

$$\begin{aligned} (x+5)(x+2)(x-4)(x-6) &= (x^2 + 7x + 10)(x^2 - 10x + 24) \\ &= x^4 - 10x^3 + 24x^2 + 7x^3 - 70x^2 + 168x + 10x^2 - 100x + 240 \\ &= x^4 - 3x^3 - 36x^2 + 68x + 240 = f(x). \end{aligned}$$

We see that this is precisely $f(x)$, so that no more polynomial division is necessary. The answer is $f(x) = (x + 5)(x + 2)(x - 4)(x - 6)$.

c) We can graph the function, or just make a guess for a root of $f(x) = x^3 + 1$. An immediate guess would be to try $x = -1$. This is indeed a root, since $f(-1) = (-1)^3 + 1 = -1 + 1 = 0$, which is also supported by the graph.

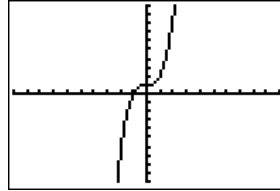

Therefore, we can divide $x^3 + 1$ by $x + 1$.

$$\begin{array}{r}
 x^2 \quad -x \quad +1 \\
 x + 1 \overline{) \begin{array}{r} x^3 \quad +0x^2 \quad +0x \quad +1 \\ -(x^3 \quad +x^2) \\ \hline -x^2 \quad +0x \quad +1 \\ -(-x^2 \quad -x) \\ \hline x \quad +1 \\ -(x \quad +1) \\ \hline 0 \end{array} }
 \end{array}$$

We obtain $f(x) = x^3 + 1 = (x^2 - x + 1)(x + 1)$. Now $x + 1$ cannot be factored any further, however, we may continue to factor $x^2 - x + 1 = (x - x_1)(x - x_2)$. Using the quadratic formula 9.12, we obtain the solutions of $x^2 - x + 1 = 0$ as

$$x_{1/2} = \frac{-(-1) \pm \sqrt{(-1)^2 - 4 \cdot 1 \cdot 1}}{2 \cdot 1} = \frac{1 \pm \sqrt{-3}}{2} = \frac{1}{2} \pm i \frac{\sqrt{3}}{2}.$$

Therefore, $x^3 + 1 = (x - (\frac{1}{2} + i\frac{\sqrt{3}}{2})) \cdot (x - (\frac{1}{2} - i\frac{\sqrt{3}}{2})) \cdot (x + 1)$.

d) For $f(x) = x^4 - 16$ there are the two obvious candidates $x = 2$ and $x = -2$ that we can identify as roots, either by guessing (since $2^4 = 16$) or by looking at the graph.

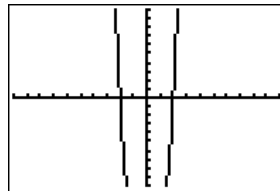

Indeed the algebra confirms these guesses.

$$\begin{aligned} f(2) &= 2^4 - 16 = 16 - 16 = 0, \\ f(-2) &= (-2)^4 - 16 = 16 - 16 = 0. \end{aligned}$$

Therefore, $f(x) = q(x) \cdot (x - 2) \cdot (x + 2) = q(x) \cdot (x^2 - 4)$. To find $q(x)$ we perform the long division $(x^4 - 16)/(x^2 - 4)$.

$$\begin{array}{r} x^2 - 4 \overline{) \begin{array}{r} x^4 \quad +0x^3 \quad +0x^2 \quad +0x \quad -16 \\ -(x^4 -4x^2) \\ \hline 4x^2 \quad +0x \quad -16 \\ -(4x^2 -16) \\ \hline 0 \end{array}} \end{array}$$

We obtain $f(x) = (x^2 + 4)(x + 2)(x - 2)$. The roots of $x^2 + 4$ are given by the quadratic formula as

$$x_{1/2} = \frac{-0 \pm \sqrt{0^2 - 4 \cdot 1 \cdot 4}}{2 \cdot 1} = \pm \frac{\sqrt{-16}}{2} = \pm \frac{4i}{2} = \pm 2i,$$

or alternatively, $x^2 + 4 = 0 \implies x^2 = -4 \implies x = \pm 2i$. We obtain the factored polynomial $f(x) = (x + 2i)(x - 2i)(x + 2)(x - 2)$. \square

As we have seen in the last example, we can use the roots to factor a polynomial completely so that all factors are polynomials of degree 1 only. Furthermore, whenever a complex root, $a + ib$, appeared, its conjugate, $a - ib$, was also a root. These remarks hold more generally, as we state now.

Observation 10.8.

- (1) Every polynomial $f(x) = a_n x^n + a_{n-1} x^{n-1} + \cdots + a_1 x + a_0$ of degree n can be factored as

$$f(x) = m \cdot (x - c_1) \cdot (x - c_2) \cdots (x - c_n).$$

- (2) In particular, every polynomial of degree n has at most n roots. (However, these roots may be real or complex.)

This shows that $f(x) = (x - 3)(x^2 + 5x + 1)$. To find the roots of f , we also have to find the roots of the second factor $x^2 + 5x + 1$, i.e., the solutions to $x^2 + 5x + 1 = 0$. The quadratic formula gives:

$$x = \frac{-5 \pm \sqrt{5^2 - 4 \cdot 1 \cdot 1}}{2 \cdot 1} = \frac{-5 \pm \sqrt{21}}{2}$$

The roots are therefore:

$$x = 3, \quad x = \frac{-5 + \sqrt{21}}{2} \approx -0.2, \quad x = \frac{-5 - \sqrt{21}}{2} \approx -4.8$$

We put these roots together with the graph in an appropriate window.

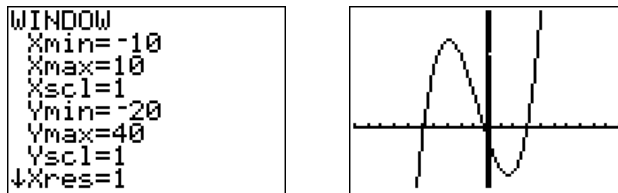

The graph including the roots is displayed below.

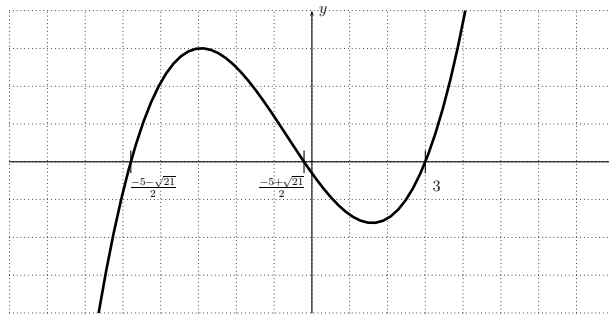

b) The graph of $f(x) = x^4 - 7x^3 + 11x^2 - 7x + 10$ in an appropriate window suggests the roots $x = 2$ and $x = 5$.

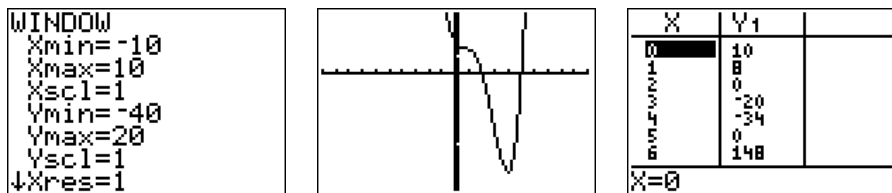

Dividing $f(x)$ by $(x - 2)(x - 5) = x^2 - 7x + 10$ gives:

$$\begin{array}{r}
 x^2 - 7x + 10 \overline{) \begin{array}{r} x^4 - 7x^3 + 11x^2 - 7x + 10 \\ -(x^4 - 7x^3 + 10x^2) \\ \hline x^2 - 7x + 10 \\ -(x^2 - 7x + 10) \\ \hline 0 \end{array} \\
 \end{array}$$

Since the roots of $x^2 + 1$ are all complex, we see that the only roots of f are $x = 2$ and $x = 5$. The graph including its roots is displayed below.

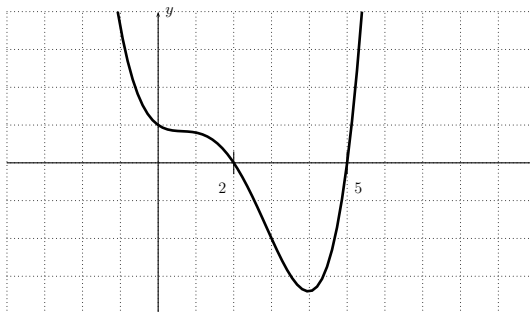

□

Example 10.10. Find a polynomial f with the following properties.

- f has degree 3, the roots of f are precisely 4, 5, 6, and the leading coefficient of f is 7
- f has degree 3 with real coefficients, f has roots $3i$, -5 (and possibly other roots as well), and $f(0) = 90$
- f has degree 4 with complex coefficients, f has roots $i + 1$, $2i$, 3
- f has degree 5 with real coefficients, the leading coefficient is 1, and the roots are determined by its graph:

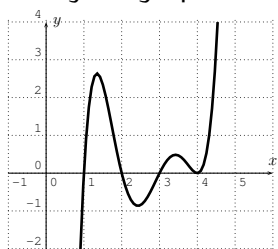

Solution. a) In general a polynomial f of degree 3 is of the form $f(x) = m \cdot (x - c_1) \cdot (x - c_2) \cdot (x - c_3)$. Identifying the roots and the leading coefficient, we obtain the polynomial

$$f(x) = 7 \cdot (x - 4) \cdot (x - 5) \cdot (x - 6).$$

b) A polynomial f of degree 3 is of the form $f(x) = m \cdot (x - c_1) \cdot (x - c_2) \cdot (x - c_3)$. Roots of f are $3i$ and -5 , and since the coefficients of f are real it follows from Observation 10.8(4), that the complex conjugate $-3i$ is also a root of f . Therefore, $f(x) = m \cdot (x + 5) \cdot (x - 3i) \cdot (x + 3i)$. To identify m , we use the last condition $f(0) = 90$.

$$90 = m \cdot (0 + 5) \cdot (0 - 3i) \cdot (0 + 3i) = m \cdot 5 \cdot (-9)i^2 = m \cdot 5 \cdot 9 = 45m$$

Dividing by 45, we obtain $m = 2$, so that

$$f(x) = 2 \cdot (x + 5) \cdot (x - 3i) \cdot (x + 3i) = 2 \cdot (x + 5) \cdot (x^2 + 9),$$

which clearly has real coefficients.

c) Since f is of degree 4 it can be written as $f(x) = m \cdot (x - c_1) \cdot (x - c_2) \cdot (x - c_3) \cdot (x - c_4)$. Three of the roots are identified as $i + 1$, $2i$, and 3 :

$$f(x) = m \cdot (x - (1 + i)) \cdot (x - 2i) \cdot (x - 3) \cdot (x - c_4)$$

However, we have no further information on the fourth root c_4 or the leading coefficient m . (Note that Observation 10.8(4) cannot be used here, since we are *not* assuming that the polynomial has *real* coefficients. Indeed it cannot have real coefficients since that would mean we would have also the complex conjugates of $1 + i$ and $2i$ in addition to the three that we are given, giving us a total of 5 roots which cannot be accommodated by a polynomial of degree 4.) We can therefore *choose any number* for these remaining variables. For example, a possible solution of the problem is given by choosing $m = 3$ and $c_4 = 2$, for which we obtain:

$$f(x) = 3 \cdot (x - (1 + i)) \cdot (x - 2i) \cdot (x - 3) \cdot (x - 2)$$

d) f is of degree 5, and we know that the leading coefficient is 1. The graph is zero at $x = 1, 2, 3$, and 4 , so that the roots are $1, 2, 3$, and 4 . Moreover, since the graph just touches the root $x = 4$, this must be a multiple root, that is, it must occur more than once (see Section 9.3 for a discussion

of multiple roots and their graphical consequences). We obtain the following solution:

$$f(x) = (x - 1)(x - 2)(x - 3)(x - 4)^2.$$

Note that the root $x = 4$ is a root of multiplicity 2. □

Note that to see that a polynomial has real coefficients, it may be necessary to multiply factors like $(x - (2 + 3i))(x - (2 - 3i))$. We suggest a way of doing this for which we use the fact that $a^2 - b^2 = (a + b)(a - b)$. We have

$$(x - (2 + 3i))(x - (2 - 3i)) = ((x - 2) - 3i)((x - 2) + 3i) = (x - 2)^2 + 9,$$

which clearly has real coefficients.

10.3 Exercises

Exercise 10.1.

- a) Find all rational roots of $f(x) = 2x^3 - 3x^2 - 3x + 2$.
- b) Find all rational roots of $f(x) = 3x^3 - x^2 + 15x - 5$.
- c) Find all rational roots of $f(x) = 6x^3 + 7x^2 - 11x - 12$.
- d) Find all real roots of $f(x) = 6x^4 + 25x^3 + 8x^2 - 7x - 2$.
- e) Find all real roots of $f(x) = 4x^3 + 9x^2 + 26x + 6$.

Exercise 10.2. Find a root of the polynomial by guessing possible candidates of the root.

- | | | |
|------------------------|-------------------------|-----------------------|
| a) $f(x) = x^5 - 1$ | b) $f(x) = x^4 - 1$ | c) $f(x) = x^3 - 27$ |
| d) $f(x) = x^3 + 1000$ | e) $f(x) = x^4 - 81$ | f) $f(x) = x^3 - 125$ |
| g) $f(x) = x^5 + 32$ | h) $f(x) = x^{777} - 1$ | i) $f(x) = x^2 + 64$ |

Exercise 10.3. Find the roots of the polynomial and use it to factor the polynomial completely.

- | | |
|----------------------------------|--|
| a) $f(x) = x^3 - 7x + 6,$ | b) $f(x) = x^3 - x^2 - 16x - 20,$ |
| c) $f(x) = x^4 - 5x^2 + 4,$ | d) $f(x) = x^3 + x^2 - 5x - 2,$ |
| e) $f(x) = 2x^3 + x^2 - 7x - 6,$ | f) $f(x) = 12x^3 + 49x^2 - 2x - 24,$ |
| g) $f(x) = x^4 - 1,$ | h) $f(x) = x^5 - 6x^4 + 8x^3 + 6x^2 - 9x,$ |
| i) $f(x) = x^3 - 27,$ | j) $f(x) = x^4 + 2x^2 - 15.$ |

Exercise 10.4. Find the exact roots of the polynomial; write the roots in simplest radical form, if necessary. Sketch a graph of the polynomial with all roots clearly marked.

- a) $f(x) = x^3 - 2x^2 - 5x + 6$, b) $f(x) = x^3 + 5x^2 + 3x - 4$,
 c) $f(x) = -x^3 + 5x^2 + 7x - 35$, d) $f(x) = x^3 + 7x^2 + 13x + 7$,
 e) $f(x) = 2x^3 - 8x^2 - 18x - 36$, f) $f(x) = x^4 - 4x^2 + 3$,
 g) $f(x) = -x^4 + x^3 + 24x^2 - 4x - 80$, h) $f(x) = 7x^3 - 11x^2 - 10x + 8$,
 i) $f(x) = -15x^3 + 41x^2 + 15x - 9$, j) $f(x) = x^4 - 6x^3 + 6x^2 + 4x$.

Exercise 10.5. Find a polynomial f that fits the given data.

- a) f has degree 3. The roots of f are precisely 2, 3, 4.
The leading coefficient of f is 2.
- b) f has degree 4. The roots of f are precisely -1 , 2, 0, -3 .
The leading coefficient of f is -1 .
- c) f has degree 3. f has roots -2 , -1 , 2, and $f(0) = 10$.
- d) f has degree 4. f has roots 0, 2, -1 , -4 , and $f(1) = 20$.
- e) f has degree 3. The coefficients of f are all real.
The roots of f are precisely $2 + 5i$, $2 - 5i$, 7.
The leading coefficient of f is 3.
- f) f has degree 3. The coefficients of f are all real.
 f has roots i , 3, and $f(0) = 6$.
- g) f has degree 4. The coefficients of f are all real.
 f has roots $5 + i$ and $5 - i$ of multiplicity 1, the root 3 of multiplicity 2, and $f(5) = 7$.
- h) f has degree 4. The coefficients of f are all real.
 f has roots i and $3 + 2i$.
- i) f has degree 6. f has complex coefficients.
 f has roots $1 + i$, $2 + i$, $4 - 3i$ of multiplicity 1 and the root -2 of multiplicity 3.
- j) f has degree 5. f has complex coefficients.
 f has roots i , 3, -7 (and possibly other roots).
- k) f has degree 3. The roots of f are determined by its graph:

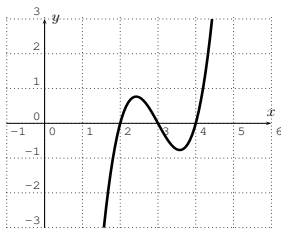

- l) f has degree 4. The coefficients of f are all real. The leading coefficient of f is 1. The roots of f are determined by its graph:

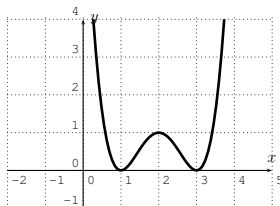

(see Section 9.3).

- m) f has degree 4. The coefficients of f are all real. f has the following graph:

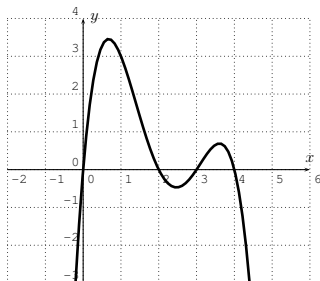

Session 11

Rational functions

11.1 Graphs of rational functions

Recall from the beginning of this chapter that a rational function is a fraction of polynomials:

$$f(x) = \frac{a_n x^n + a_{n-1} x^{n-1} + \cdots + a_1 x + a_0}{b_m x^m + b_{m-1} x^{m-1} + \cdots + b_1 x + b_0}$$

In this section, we will study some characteristics of graphs of rational functions. *Asymptotes* are important features of graphs of rational functions. An *asymptote* is a line that is approached by the graph of a function: $x = a$ is a *vertical asymptote* if $f(x)$ approaches $\pm\infty$ as x approaches a from either the left or from the right, and $y = b$ is a *horizontal asymptote* if $f(x)$ approaches b as x approaches ∞ or $-\infty$.

To obtain a better idea of some of these features including asymptotes, we start by graphing some rational functions. In particular it is useful to know the graphs of the basic functions $y = \frac{1}{x^n}$.

Observation 11.1. Graphing $y = \frac{1}{x}$, $y = \frac{1}{x^2}$, $y = \frac{1}{x^3}$, $y = \frac{1}{x^4}$, we obtain:

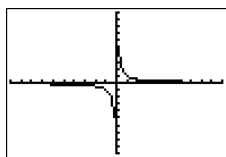

$$y = \frac{1}{x}$$

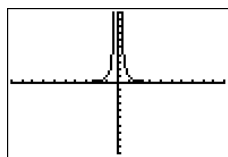

$$y = \frac{1}{x^2}$$

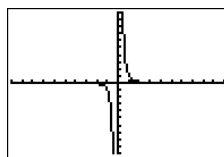

$$y = \frac{1}{x^3}$$

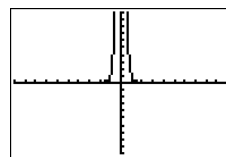

$$y = \frac{1}{x^4}$$

In general we see that $x = 0$ is a vertical asymptote and $y = 0$ is a horizontal asymptote. The shape of $y = \frac{1}{x^n}$ depends on n being even or odd. We have:

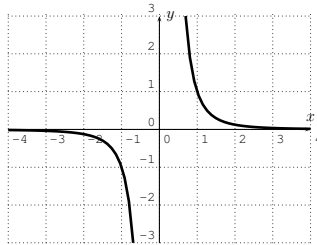

$$y = \frac{1}{x^n}, n \text{ odd}$$

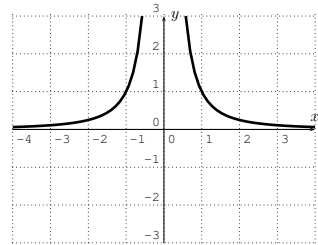

$$y = \frac{1}{x^n}, n \text{ even}$$

We now study more general rational functions.

Example 11.2. a) Our first graph is $f(x) = \frac{1}{x-3}$.

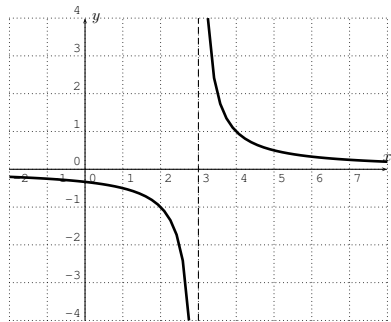
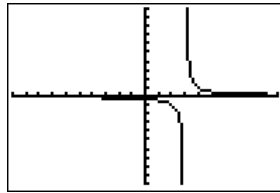

Here, the domain is all numbers where the denominator is not zero, that is $D = \mathbb{R} - \{3\}$. There is a vertical asymptote, $x = 3$. Furthermore, the graph approaches 0 as x approaches $\pm\infty$. Therefore, f has a horizontal asymptote, $y = 0$. Indeed, whenever the denominator has a higher degree than the numerator, the line $y = 0$ will be the horizontal asymptote.

b) Next, we graph $f(x) = \frac{8x^2-8}{4x^2-16}$.

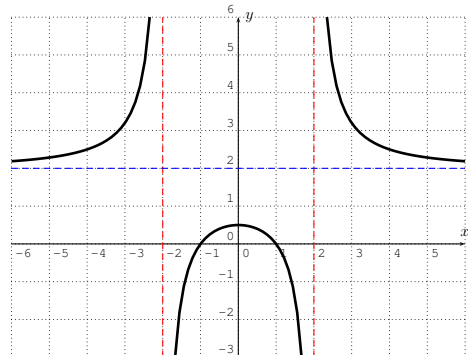
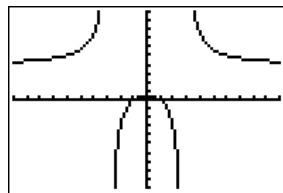

Here, the domain is all x for which $4x^2 - 16 \neq 0$. To see where this happens, calculate

$$4x^2 - 16 = 0 \implies 4x^2 = 16 \implies x^2 = 4 \implies x = \pm 2.$$

Therefore, the domain is $D = \mathbb{R} - \{-2, 2\}$. As before, we see from the graph, that the domain reveals the vertical asymptotes $x = 2$ and $x = -2$ (the vertical dashed lines). To find the horizontal asymptote (the horizontal dashed line), we note that when x becomes very large, the highest terms of both numerator and denominator dominate the function value, so that

$$\text{for } |x| \text{ very large } \implies f(x) = \frac{8x^2 - 8}{4x^2 - 16} \approx \frac{8x^2}{4x^2} = 2$$

Therefore, when x approaches $\pm\infty$, the function value $f(x)$ approaches 2, and therefore the horizontal asymptote is at $y = 2$ (the horizontal dashed line).

c) Our next graph is $f(x) = \frac{x^2 - 8x + 15}{x - 3}$.

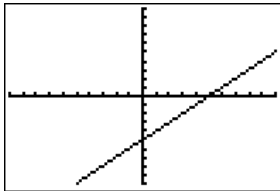

X	Y1
0	-5
1	-4
2	-3
3	ERROR
4	-1
5	0
6	1

X=0

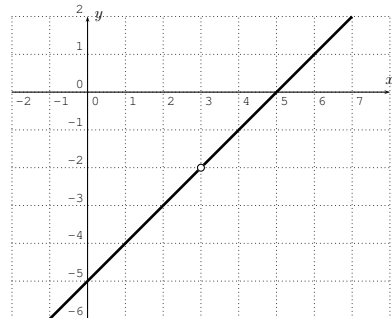

We see that there does not appear to be any vertical asymptote, despite the fact that 3 is not in the domain. The reason for this is that we can “remove the singularity” by cancelling the troubling term $x - 3$ as follows:

$$f(x) = \frac{x^2 - 8x + 15}{x - 3} = \frac{(x - 3)(x - 5)}{(x - 3)} = \frac{x - 5}{1} = x - 5, \quad x \neq 3$$

Therefore, the function f reduces to $x - 5$ for all values where it is defined. However, note that $f(x) = \frac{x^2 - 8x + 15}{x - 3}$ is not defined at $x = 3$. We denote this in the graph by an open circle at $x = 3$, and call this a removable singularity (or a hole).

d) Our fourth and last graph before stating the rules in full generality is $f(x) = \frac{2x^3 - 8}{3x^2 - 16}$.

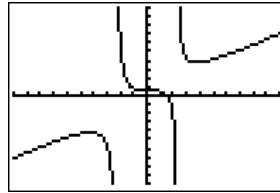

The graph indicates that there is no horizontal asymptote, as the graph appears to increase towards ∞ and decrease towards $-\infty$. To make this observation precise, we calculate the behavior when x approaches $\pm\infty$ by ignoring the lower terms in the numerator and denominator

$$\text{for } |x| \text{ very large} \implies f(x) = \frac{2x^3 - 8}{3x^2 - 16} \approx \frac{2x^3}{3x^2} = \frac{2x}{3}$$

Therefore, when x becomes very large, $f(x)$ behaves like $\frac{2}{3}x$, which approaches ∞ when x approaches ∞ , and approaches $-\infty$ when x approaches $-\infty$. (In fact, after performing a long division we obtain $\frac{2x^3 - 8}{3x^2 - 16} = \frac{2}{3} \cdot x + \frac{r(x)}{3x^2 - 16}$, which would give rise to what is called a *slant asymptote* $y = \frac{2}{3} \cdot x$; see also remark 11.4 below.) Indeed, whenever the degree of the numerator is greater than the degree of the denominator, we find that there is no horizontal asymptote, but the graph blows up to $\pm\infty$. (Compare this also with example (c) above).

Combining what we have learned from the above examples, we state our observations as follows.

Observation 11.3. Let $f(x) = \frac{p(x)}{q(x)}$ be a rational function with polynomials $p(x)$ and $q(x)$ in the numerator and denominator, respectively.

- The **domain** of f is all real numbers x for which the denominator is not zero,

$$D = \{ x \in \mathbb{R} \mid q(x) \neq 0 \}$$

- Assume that $q(x_0) = 0$, so that f is not defined at x_0 . If x_0 is not a root of $p(x)$, or if x_0 is a root of $p(x)$ but of a lesser multiplicity than the

root in $q(x)$, then f has a **vertical asymptote** $x = x_0$.

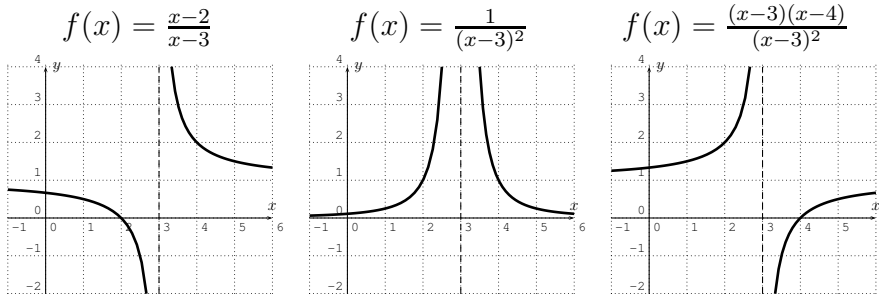

- If $p(x_0) = 0$ and $q(x_0) = 0$, and the multiplicity of the root x_0 in $p(x)$ is at least the multiplicity of the root in $q(x)$, then these roots can be canceled, and it is said that there is a **removable discontinuity** (or sometimes called a **hole**) at $x = x_0$.

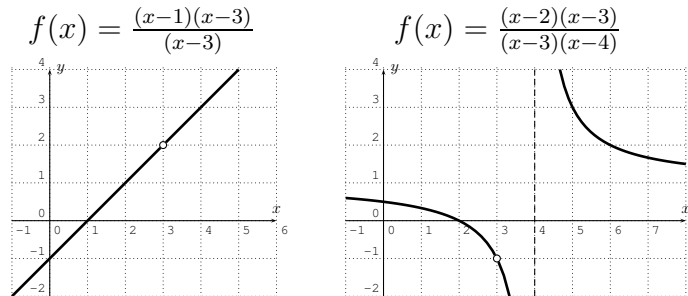

- To find the **horizontal asymptotes**, we need to distinguish the cases where the degree of $p(x)$ is less than, equal to, or greater than $q(x)$.

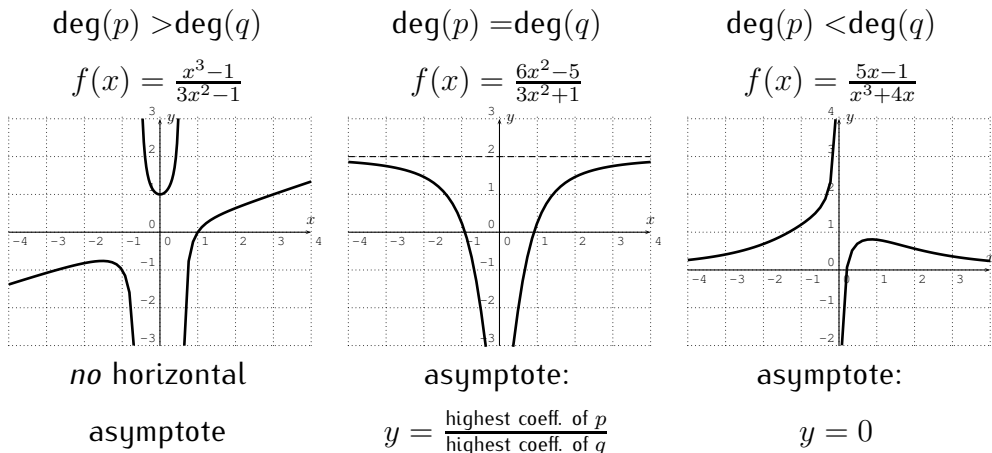

In addition, it is sometimes useful to determine the x - and y -intercepts.

- If 0 is in the domain of f , then the y -intercept is $(0, f(0))$.

$$f(x) = \frac{x+2}{x+1}$$

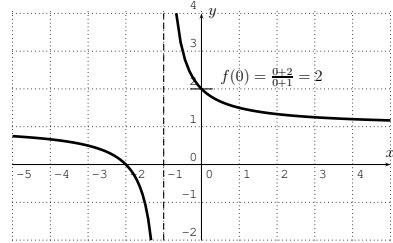

- If $p(x_0) = 0$ but $q(x_0) \neq 0$, then $f(x_0) = \frac{p(x_0)}{q(x_0)} = \frac{0}{q(x_0)} = 0$, so that $(x_0, 0)$ is an x -intercept, that is the graph intersects with the x -axis at x_0 .

$$f(x) = \frac{x-2}{x-3}$$

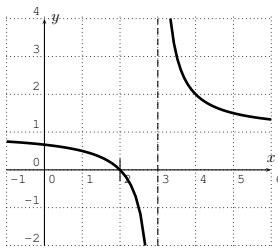

$$f(x) = \frac{(x-2)(x-4)(x-5)}{(x-3)^3}$$

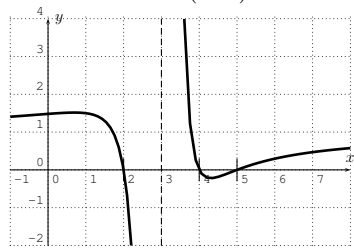

Remark 11.4. We can calculate the asymptotic behavior of a rational function $f(x) = \frac{p(x)}{q(x)}$ in the case where the degree of p is greater than the degree of q by performing a long division. If the quotient is $m(x)$, and the remainder is $r(x)$, then

$$f(x) = \frac{p(x)}{q(x)} = m(x) + \frac{r(x)}{q(x)}.$$

Now, since $\deg(r) < \deg(q)$, the fraction $\frac{r(x)}{q(x)}$ approaches zero as x approaches $\pm\infty$, so that $f(x) \approx m(x)$ for large x .

Example 11.5. Find the domain, all horizontal asymptotes, vertical asymptotes, removable singularities, and x - and y -intercepts. Use this information together with the graph of the calculator to sketch the graph of f .

- a) $f(x) = \frac{-x^2}{x^2-3x-4}$ b) $f(x) = \frac{5x}{x^2-2x}$ c) $f(x) = \frac{x^3-9x^2+26x-24}{x^2-x-2}$
 d) $f(x) = \frac{x-4}{(x-2)^2}$ e) $f(x) = \frac{3x^2-12}{2x^2+1}$

Solution. a) We combine our knowledge of rational functions and its algebra with the particular graph of the function. The calculator gives the following graph.

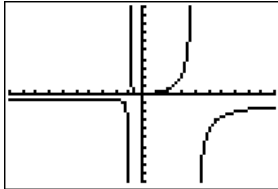

To find the domain of f we only need to exclude from the real numbers those x that make the denominator zero. Since $x^2 - 3x - 4 = 0$ exactly when $(x + 1)(x - 4) = 0$, which gives $x = -1$ or $x = 4$, we have the domain:

$$\text{domain } D = \mathbb{R} - \{-1, 4\}$$

The numerator has a root exactly when $-x^2 = 0$, that is $x = 0$. Therefore, $x = -1$ and $x = 4$ are vertical asymptotes, and since we cannot cancel terms in the fraction, there is no removable singularity. Furthermore, since $f(x) = 0$ exactly when the numerator is zero, the only x -intercept is $(0, 0)$.

To find the horizontal asymptote, we consider $f(x)$ for large values of x by ignoring the lower order terms in numerator and denominator,

$$|x| \text{ large} \implies f(x) \approx \frac{-x^2}{x^2} = -1$$

We see that the horizontal asymptote is $y = -1$. Finally, for the y -intercept, we calculate $f(0)$:

$$f(0) = \frac{-0^2}{0^2 - 3 \cdot 0 - 4} = \frac{0}{-4} = 0.$$

Therefore, the y -intercept is $(0,0)$. The function is then graphed as follows.

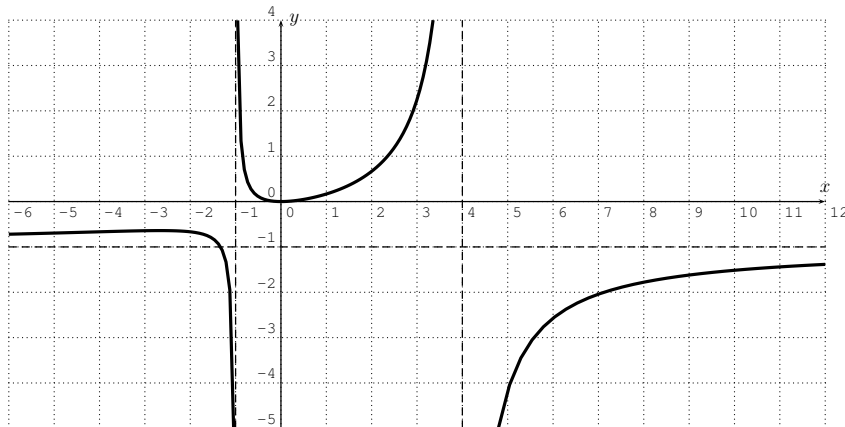

b) The graph of $f(x) = \frac{5x}{x^2-2x}$ as drawn with the TI-84 is the following.

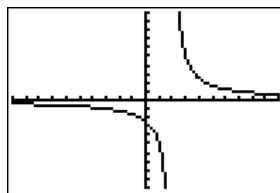

For the domain, we find the roots of the denominator,

$$x^2 - 2x = 0 \implies x(x - 2) = 0 \implies x = 0 \text{ or } x = 2.$$

The domain is $D = \mathbb{R} - \{0, 2\}$. For the vertical asymptotes and removable singularities, we calculate the roots of the numerator,

$$5x = 0 \implies x = 0.$$

Therefore, $x = 2$ is a vertical asymptote, and $x = 0$ is a removable singularity. Furthermore, the denominator has a higher degree than the numerator, so that $y = 0$ is the horizontal asymptote. For the y -intercept, we calculate $f(0)$ by evaluating the fraction $f(x)$ at 0

$$\frac{5 \cdot 0}{0^2 - 2 \cdot 0} = \frac{0}{0},$$

which is undefined. Therefore, there is no y -intercept (we, of course, already noted that there is a removable singularity when $x = 0$). Finally for the

x -intercept, we need to analyze where $f(x) = 0$, that is where $5x = 0$. The only candidate is $x = 0$ for which f is undefined. Again, we see that there is no x -intercept. The function is then graphed as follows. (Notice in particular the removable singularity at $x = 0$.)

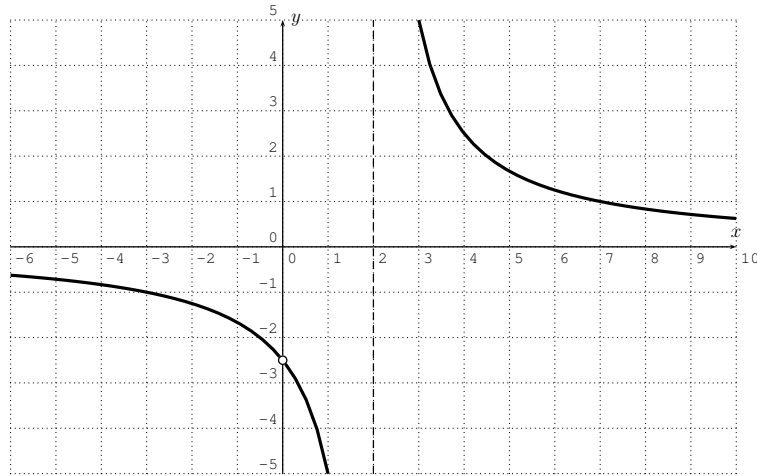

c) We start again by graphing the function $f(x) = \frac{x^3 - 9x^2 + 26x - 24}{x^2 - x - 2}$ with the calculator. After zooming to an appropriate window, we get:

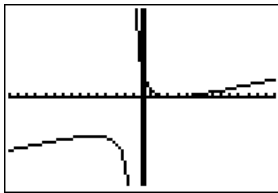

To find the domain of f , we find the zeros of the denominator

$$x^2 - x - 2 = 0 \implies (x + 1)(x - 2) = 0 \implies x = -1 \text{ or } x = 2.$$

The domain is $D = \mathbb{R} - \{-1, 2\}$. The graph suggests that there is a vertical asymptote $x = -1$. However the $x = 2$ appears not to be a vertical asymptote. This would happen when $x = 2$ is a removable singularity, that is, $x = 2$ is a root of both numerator and denominator of $f(x) = \frac{p(x)}{q(x)}$. To confirm this, we calculate the numerator $p(x)$ at $x = 2$:

$$p(2) = 2^3 - 9 \cdot 2^2 + 26 \cdot 2 - 24 = 8 - 36 + 52 - 24 = 0$$

We draw the graph as follows:

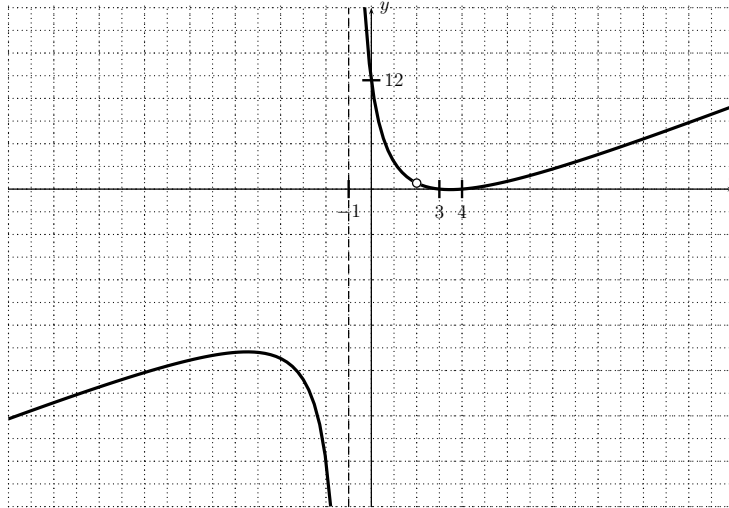

d) We first graph $f(x) = \frac{x-4}{(x-2)^2}$. (Don't forget to set the viewing window back to the standard settings!)

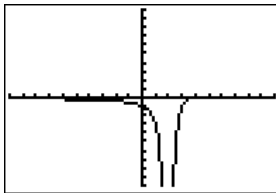

The domain is all real numbers except where the denominator becomes zero, that is, $D = \mathbb{R} - \{2\}$. The graph has a vertical asymptote $x = 2$ and no hole. The horizontal asymptote is at $y = 0$, since the denominator has a higher degree than the numerator. The y -intercept is at $y_0 = f(0) = \frac{0-4}{(0-2)^2} = \frac{-4}{4} = -1$. The x -intercept is where the numerator is zero, $x - 4 = 0$, that is at $x = 4$. Since the above graph did not show the x -intercept, we can confirm this by changing the window size as follows:

```

WINDOW
Xmin=-10
Xmax=20
Xscl=1
Ymin=-1.5
Ymax=.5
Yscl=1
↓Xres=1
    
```

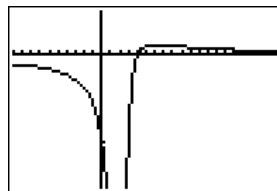

Note in particular that the graph intersects the x -axis at $x = 4$ and then changes its direction to approach the x -axis from above. A graph of the function f which includes all these features is displayed below.

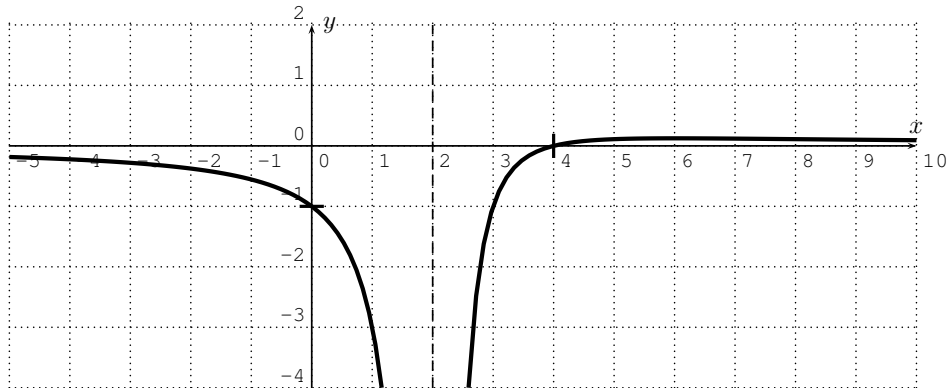

e) We graph $f(x) = \frac{3x^2 - 12}{2x^2 + 1}$.

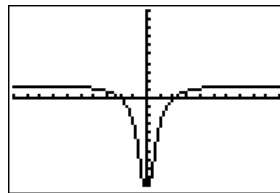

For the domain, we determine the zeros of the denominator.

$$2x^2 + 1 = 0 \implies 2x^2 = -1 \implies x^2 = -\frac{1}{2}.$$

The only solutions of this equation are given by complex numbers, but not by any real numbers. In particular, for any real number x , the denominator of $f(x)$ is not zero. The domain of f is all real numbers, $D = \mathbb{R}$. This implies in turn that there are no vertical asymptotes, and no removable singularities.

The x -intercepts are determined by $f(x) = 0$, that is where the numerator is zero,

$$3x^2 - 12 = 0 \implies 3x^2 = 12 \implies x^2 = 4 \implies x = \pm 2.$$

The horizontal asymptote is given by $f(x) \approx \frac{3x^2}{2x^2} = \frac{3}{2}$, that is, it is at $y = \frac{3}{2} = 1.5$. The y -intercept is at

$$y = f(0) = \frac{3 \cdot 0^2 - 12}{2 \cdot 0^2 + 1} = \frac{-12}{1} = -12.$$

We sketch the graph as follows:

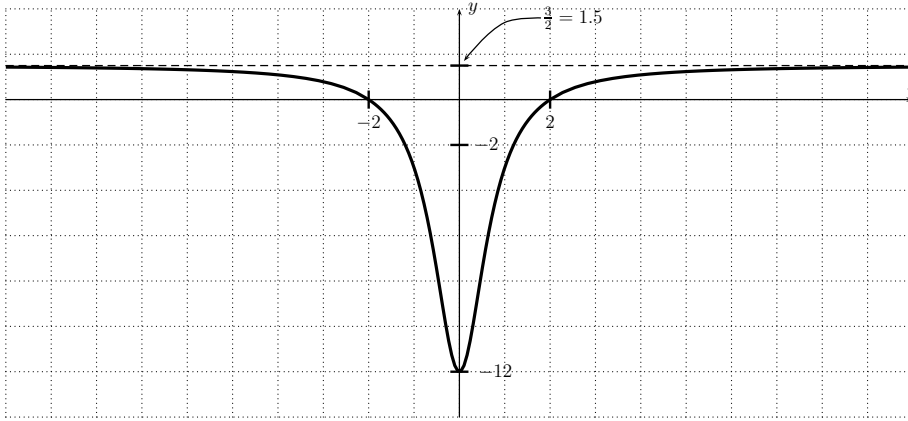

Since the graph is symmetric with respect to the y -axis, we can make one more observation, namely that the function f is even (see observation 5.11 on page 72):

$$f(-x) = \frac{3(-x)^2 - 12}{2(-x)^2 + 1} = \frac{3x^2 - 12}{2x^2 + 1} = f(x)$$

□

11.2 *Optional section:* Graphing rational functions by hand

In this section we will show how to sketch the graph of a factored rational function without the use of a calculator. It will be helpful to the reader to have read section 9.3 on graphing a polynomial by hand before continuing in this section. In addition to having the same difficulties as polynomials, calculators often have difficulty graphing rational functions near an asymptote.

Example 11.6. Graph the function $p(x) = \frac{-3x^2(x-2)^3(x+2)}{(x-1)(x+1)^2(x-3)^3}$.

Solution. We can see that p has zeros at $x = 0, 2$, and -2 and vertical asymptotes $x = 1, x = -1$ and $x = 3$. Also note that for large $|x|$, $p(x) \approx -3$. So there is a horizontal asymptote $y = -3$. We indicate each of these facts

on the graph:

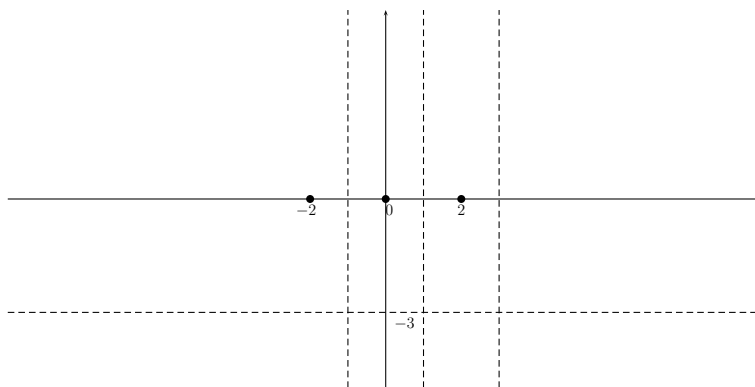

We can in fact get a more precise statement by performing a long division and writing $p(x) = \frac{n(x)}{d(x)} = -3 + \frac{r(x)}{d(x)}$. If you drop all but the leading order terms in the numerator and the denominator of the second term, we see that $p(x) \approx -3 - \frac{12}{x}$ whose graph for large $|x|$ looks like

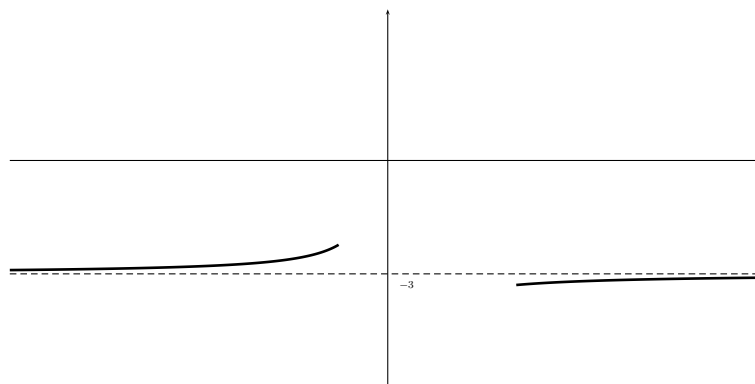

This sort of reasoning can make the graph a little more accurate but is not necessary for a sketch.

We also have the following table:

for a	near a , $p(x) \approx$	type	sign change at a
-2	$C_1(x + 2)$	linear	changes
-1	$C_2/(x + 1)^2$	asymptote	does not change
0	$C_3 x^2$	parabola	does not change
1	$C_4/(x - 1)$	asymptote	changes
2	$C_5(x - 2)^3$	cubic	changes
3	$C_6/(x - 3)^3$	asymptote	changes

Note that if the power appearing in the second column is even then the function does not change from one side of a to the other. If the power is odd, the sign changes (either from positive to negative or from negative to positive).

Now we move from large negative x values toward the right, taking into account the above table. For large negative x , we start our sketch as follows:

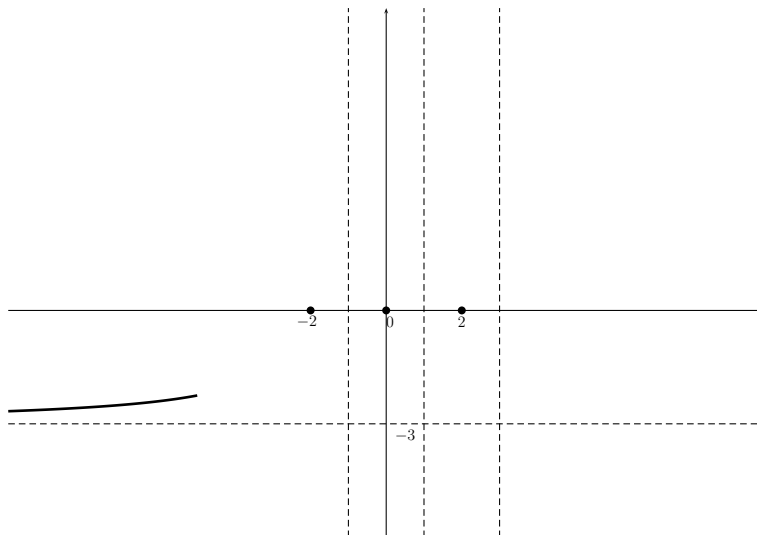

And noting that near $x = -2$ the function $p(x)$ is approximately linear, we have

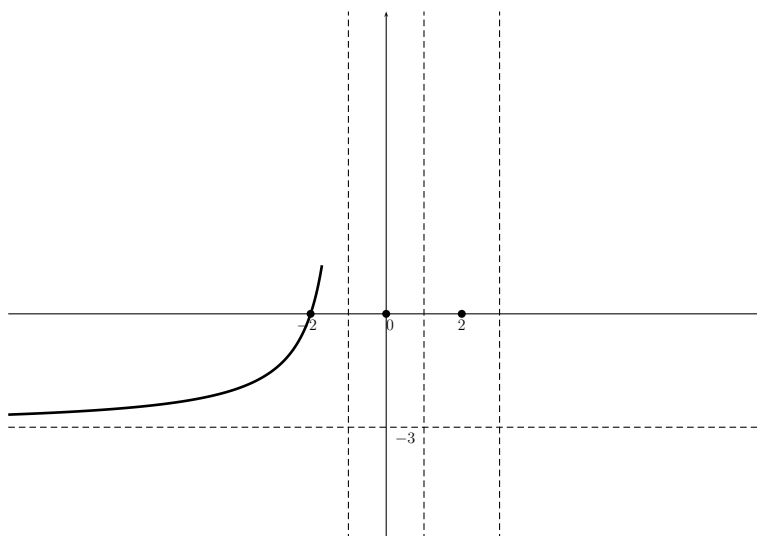

Then noting that we have an asymptote (noting that we can not cross the

x -axis without creating an x -intercept) we have

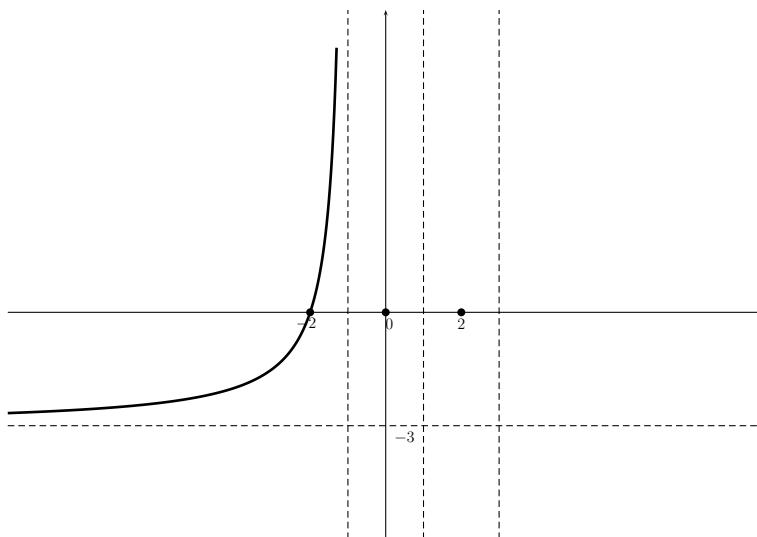

Now, from the table we see that there is no sign change at -1 so we have

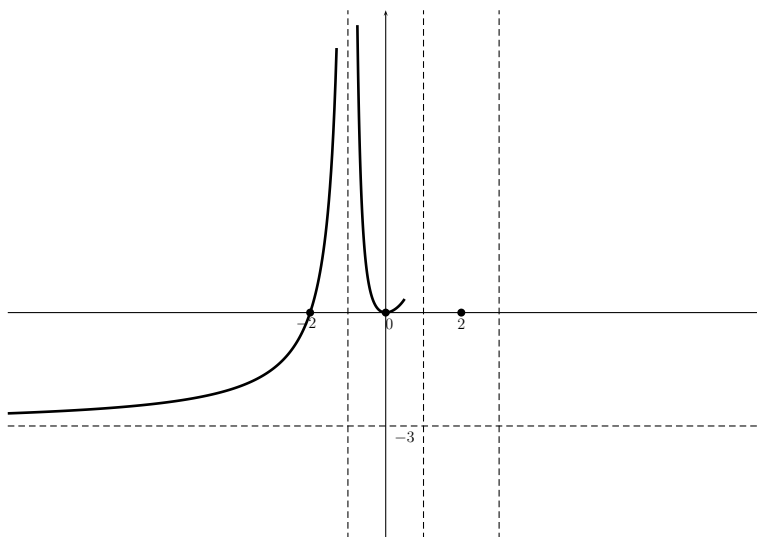

and from the table we see that near $x = 0$ the function $p(x)$ is approximately quadratic and therefore the graph looks like a parabola. This together with

the fact that there is an asymptote at $x = 1$ gives

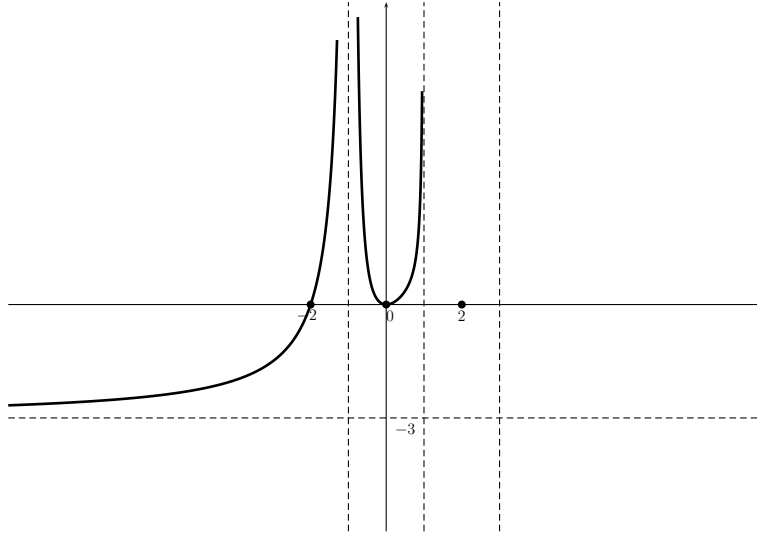

Now, from the table we see that the function changes sign at the asymptote, so while the graph “hugs” the top of the asymptote on the left hand side, it “hugs” the bottom on the right hand side giving

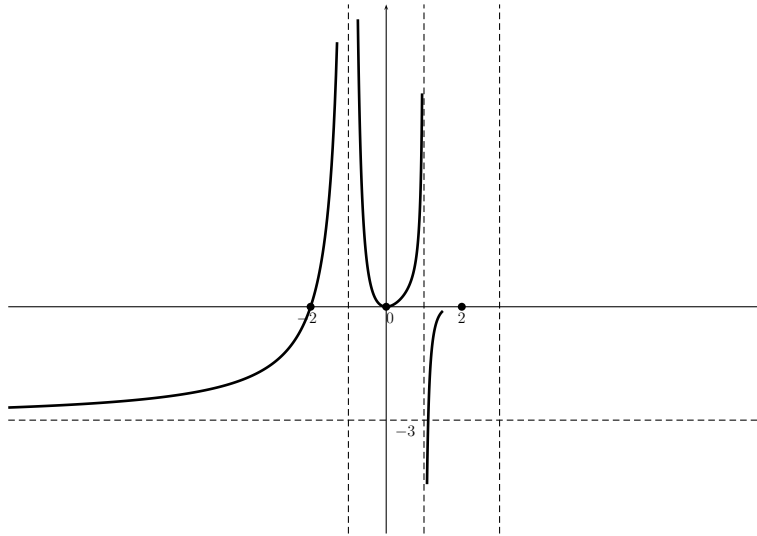

Now, from the table we see that near $x = 2$, $p(x)$ is approximately cubic.

Also, there is an asymptote $x = 3$ so we get

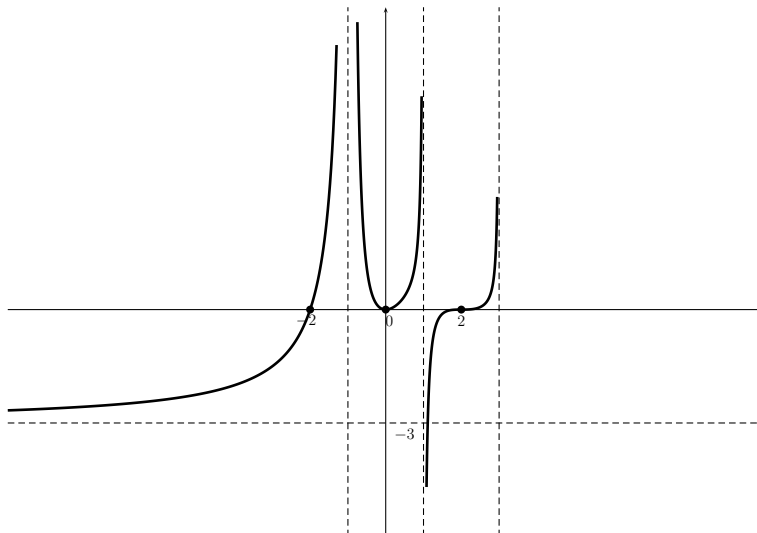

Finally, we see from the table that $p(x)$ changes sign at the asymptote $x = 3$ and has a horizontal asymptote $y = -3$, so we complete the sketch:

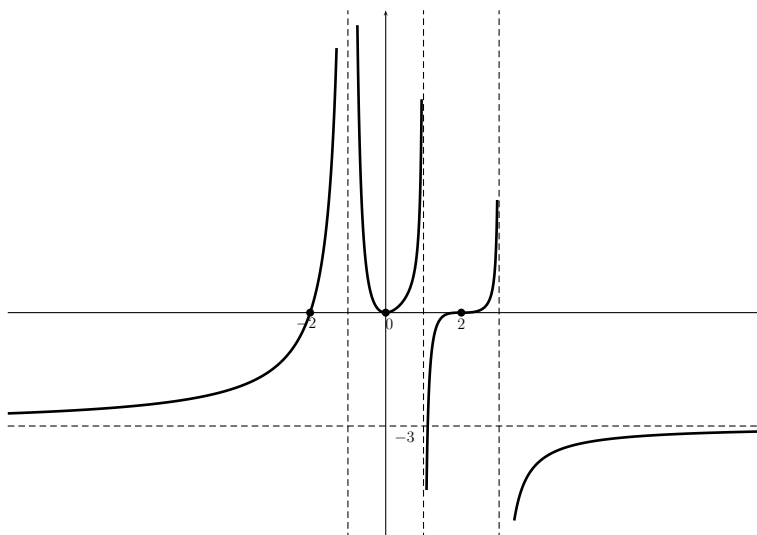

Note that if we had made a mistake somewhere there is a good chance that we would have not been able to get to the horizontal asymptote on the right side without creating an additional x -intercept.

What can we conclude from this sketch? This sketch exhibits only the general shape which can help decide on an appropriate window if we want to

investigate details using technology. Furthermore, we can infer where $p(x)$ is positive and where $p(x)$ is negative. However, it is important to notice, that there may be wiggles in the graph that we have not included in our sketch. \square

We now give one more example of graphing a rational function where the horizontal asymptote is $y = 0$.

Example 11.7. Sketch the graph of

$$r(x) = \frac{2x^2(x-1)^3(x+2)}{(x+1)^4(x-2)^3}.$$

Solution. Here we see that there are x -intercepts at $(0, 0)$, $(0, 1)$, and $(0, -2)$. There are two vertical asymptotes: $x = -1$ and $x = 2$. In addition, there is a horizontal asymptote at $y = 0$. (Why?) Putting this information on the graph gives

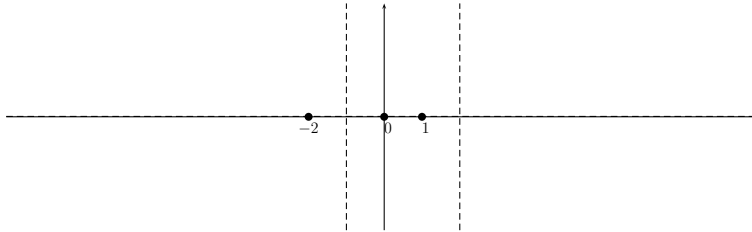

In this case, it is easy to get more information for large $|x|$ that will be helpful in sketching the function. Indeed, when $|x|$ is large, we can approximate $r(x)$ by dropping all but the highest order term in the numerator and denominator which gives $r(x) \approx \frac{2x^6}{x^7} = \frac{2}{x}$. So for large $|x|$, the graph of r looks like

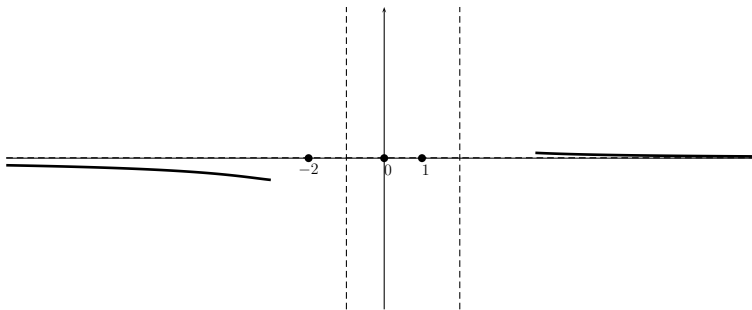

The function gives the following table:

for a	near a , $p(x) \approx$	type	sign change at a
-2	$C_1(x + 2)$	linear	changes
-1	$C_2/(x + 1)^4$	asymptote	does not change
0	$C_3 x^2$	parabola	does not change
1	$C_4(x - 1)^3$	cubic	changes
2	$C_5/(x - 2)^3$	asymptote	changes

Looking at the table for this function, we see that the graph should look like a line near the zero $(0, -2)$ and since it has an asymptote $x = -1$, the graph looks something like:

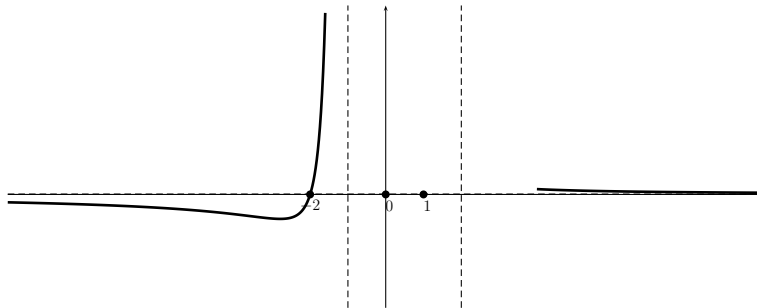

Then, looking at the table we see that $r(x)$ does not change its sign near $x = -1$, so that we obtain:

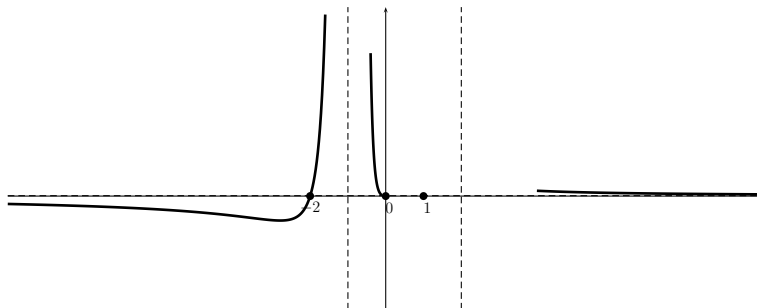

Now, the function is approximately quadratic near $x = 0$ so the graph looks

like:

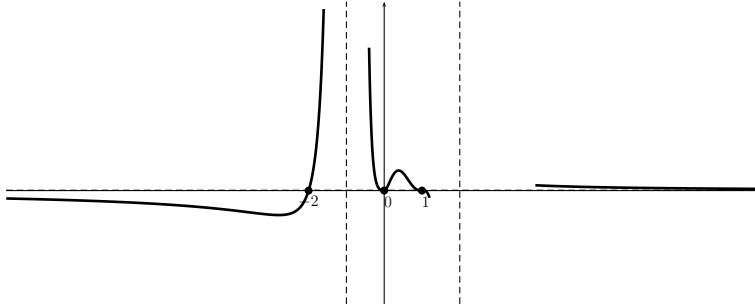

Turning to head toward the root at 1 and noting that the function is approximately cubic there, and that there is an asymptote $x = 2$, we have:

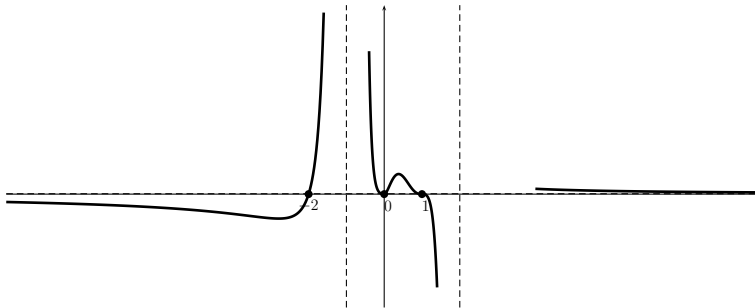

Finally, we see that the function changes sign at $x = 2$ (see the table). So since the graph “hugs” the asymptote near the bottom of the graph on the left side of the asymptote, it will “hug” the asymptote near the top on the right side. So this together with the fact that $y = 0$ is an asymptote gives the sketch (perhaps using an eraser to match the part of the graph on the right that uses the large x):

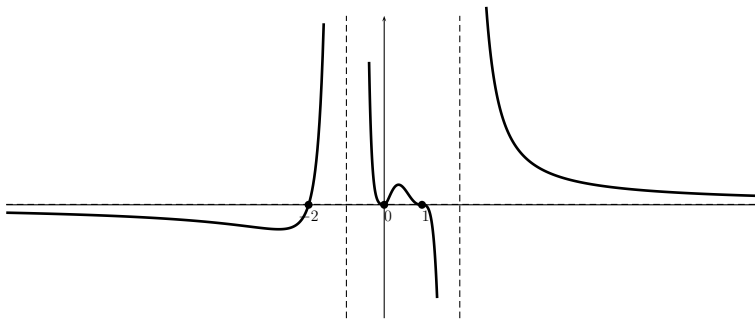

Note that if the graph couldn't be matched at the end without creating an extra x -intercept, then a mistake has been made. \square

11.3 Exercises

Exercise 11.1. Find the domain, the vertical asymptotes and removable discontinuities of the functions.

$$\begin{array}{ll} \text{a) } f(x) = \frac{2}{x-2} & \text{b) } f(x) = \frac{x^2+2}{x^2-6x+8} \\ \text{c) } f(x) = \frac{3x+6}{x^3-4x} & \text{d) } f(x) = \frac{(x-2)(x+3)(x+4)}{(x-2)^2(x+3)(x-5)} \\ \text{e) } f(x) = \frac{x-1}{x^3-1} & \text{f) } f(x) = \frac{2}{x^3-2x^2-x+2} \end{array}$$

Exercise 11.2. Find the horizontal asymptotes of the functions.

$$\begin{array}{ll} \text{a) } f(x) = \frac{8x^2+2x+1}{2x^2+3x-2} & \text{b) } f(x) = \frac{1}{(x-3)^2} \\ \text{c) } f(x) = \frac{x^2+3x+2}{x-1} & \text{d) } f(x) = \frac{12x^3-4x+2}{-3x^3+2x^2+1} \end{array}$$

Exercise 11.3. Find the x - and y -intercepts of the functions.

$$\begin{array}{ll} \text{a) } f(x) = \frac{x-3}{x-1} & \text{b) } f(x) = \frac{x^3-4x}{x^2-8x+15} \\ \text{c) } f(x) = \frac{(x-3)(x-1)(x+4)}{(x-2)(x-5)} & \text{d) } f(x) = \frac{x^2+5x+6}{x^2+2x} \end{array}$$

Exercise 11.4. Sketch the graph of the function f by using the domain of f , the horizontal and vertical asymptotes, the removable singularities, the x - and y -intercepts of the function, together with a sketch of the graph obtained from the calculator.

$$\begin{array}{ll} \text{a) } f(x) = \frac{6x-2}{2x+4} & \text{b) } f(x) = \frac{x-3}{x^3-3x^2-6x+8} \\ \text{c) } f(x) = \frac{x^4-10x^2+9}{x^2-3x+2} & \text{d) } f(x) = \frac{x^3-3x^2-x+3}{x^3-2x^2} \end{array}$$

Exercise 11.5. Find a rational function f that satisfies all the given properties.

- a) vertical asymptote at $x = 4$ and horizontal asymptote $y = 0$
- b) vertical asymptotes at $x = 2$ and $x = 3$ and horizontal asymptote $y = 5$
- c) removable singularity at $x = 1$ and no horizontal asymptote

Session 12

Polynomial and rational inequalities

12.1 Polynomial inequalities

We now consider inequalities. Solving inequalities is quite similar to solving equalities. There is one extra consideration, that multiplying or dividing by a negative number on both sides of an inequality changes the direction of the inequality sign.

$$\begin{array}{l} -2x \leq -6 \implies x \geq 3 \\ \text{but } 2x \leq 6 \implies x \leq 3 \end{array}$$

Example 12.1. Solve for x .

$$\begin{array}{ll} \text{a) } -3x + 7 > 19, & \text{b) } 2x + 5 \geq 4x - 11 \\ \text{c) } 3 < -6x - 4 \leq 13, & \text{d) } -2x - 1 \leq 3x + 4 < 4x - 20 \end{array}$$

Solution. The first three calculations are straightforward.

$$\begin{array}{ll} \text{a) } -3x + 7 > 19 & \xrightarrow{(-7)} -3x > 12 \xrightarrow{(\div(-3))} x < -4 \\ \text{b) } 2x + 5 \geq 4x - 11 & \xrightarrow{(-4x-5)} -2x \geq -16 \xrightarrow{(\div(-2))} x \leq 8 \\ \text{c) } 3 < -6x - 4 \leq 13 & \xrightarrow{(+4)} 7 < -6x \leq 17 \xrightarrow{(\div(-6))} \frac{7}{-6} > x \geq \frac{17}{-6} \\ & \implies -\frac{17}{6} \leq x < -\frac{7}{6}, \end{array}$$

The last implication was obtained by switching the right and left terms of the inequality. The solution set is the interval $[-\frac{17}{6}, -\frac{7}{6})$.

For part (d), it is best to consider both inequalities separately.

$$\begin{aligned} -2x - 1 \leq 3x + 4 &\xrightarrow{(-3x+1)} -5x \leq 5 \xrightarrow{(\div(-5))} x \geq -1, \\ 3x + 4 < 4x - 20 &\xrightarrow{(-4x-4)} -x < -24 \xrightarrow{(\cdot(-1))} x > 24. \end{aligned}$$

The solution has to satisfy *both* inequalities $x \geq -1$ and $x > 24$. Both inequalities are true for $x > 24$ (since then also $x \geq -1$), so that this is in fact the solution: $x > 24$. \square

When dealing with polynomial inequalities, we use the same three-step strategy that we used in section 1.4. More precisely, the *first step* is to solve the corresponding equality, and the *second step* is to determine the solution by investigating the subintervals induced from step 1. For both of these steps we may now also use the graph of the function and its display on the graphing calculator. The *third step* is to check the endpoints of each interval.

Example 12.2. Solve for x .

$$\begin{aligned} \text{a) } x^2 - 3x - 4 &\geq 0 & \text{b) } x^3 - 9x^2 + 23x - 15 &\leq 0 \\ \text{c) } x^4 - x^2 &> 5(x^3 - x) & \text{d) } x^3 + 15x &> 7x^2 + 9 \\ \text{e) } x^5 - 6x^4 - 26x^3 + 144x^2 - 47x - 210 &\leq 0 \end{aligned}$$

Solution. a) We can find the roots of the polynomial on the left by factoring.

$$x^2 - 3x - 4 = 0 \implies (x - 4)(x + 1) = 0 \implies x = 4 \text{ or } x = -1$$

To see where $f(x) = x^2 - 3x - 4$ is ≥ 0 , we graph it with the calculator.

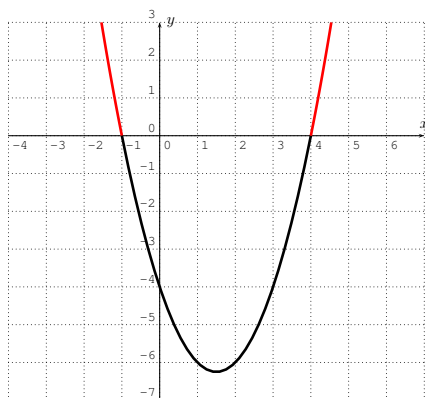
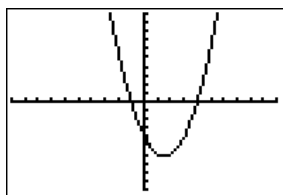

We see that $f(x) \geq 0$ when $x \leq -1$ and when $x \geq 4$ (the parts of the graph above the x -axis). The solution set is therefore

$$\{x|x \leq -1, \text{ or } x \geq 4\} = (-\infty, -1] \cup [4, \infty).$$

b) Here is the graph of the function $f(x) = x^3 - 9x^2 + 23x - 15$ with the TI-84 in the standard window.

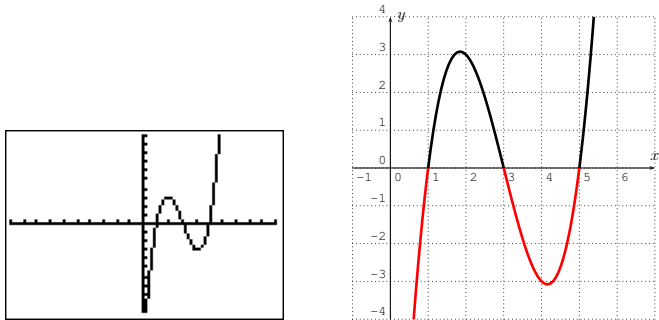

This graph shows that there are two intervals where $f(x) \leq 0$ (the parts of the graph below the x -axis). To determine the exact intervals, we calculate where $f(x) = x^3 - 9x^2 + 23x - 15 = 0$. The graph suggests that the roots of $f(x)$ are at $x = 1$, $x = 3$, and $x = 5$. This can be confirmed by a calculation:

$$f(1) = 1^3 - 9 \cdot 1^2 + 23 \cdot 1 - 15 = 1 - 9 + 23 - 15 = 0,$$

$$f(3) = 3^3 - 9 \cdot 3^2 + 23 \cdot 3 - 15 = 27 - 81 + 69 - 15 = 0,$$

$$f(5) = 5^3 - 9 \cdot 5^2 + 23 \cdot 5 - 15 = 125 - 225 + 115 - 15 = 0.$$

Since f is a polynomial of degree 3, the roots $x = 1, 3, 5$ are all of the roots of f . (Alternatively, we could have divided $f(x)$, for example, by $x - 1$ and used this to completely factor f and with this obtain all the roots of f .) With this, we can determine the solution set to be the set:

$$\begin{aligned} \text{solution set} &= \{x \in \mathbb{R} | x \leq 1, \text{ or } 3 \leq x \leq 5\} \\ &= (-\infty, 1] \cup [3, 5]. \end{aligned}$$

Note that we include the roots 1, 3, and 5 in the solution set since the original inequality was " \leq " (and not " $<$ "), which includes the solutions of the corresponding equality.

c) In order to use the graphing calculator, we rewrite the inequality to obtain zero on one side of the inequality.

$$x^4 - x^2 > 5(x^3 - x) \quad (\text{distribute } 5) \implies x^4 - x^2 > 5x^3 - 5x$$

$$(\text{subtract } 5x^3, \text{ add } 5x) \implies x^4 - 5x^3 - x^2 + 5x > 0.$$

We graph $f(x) = x^4 - 5x^3 - x^2 + 5x$ with the TI-84.

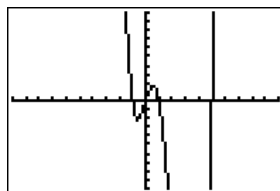

The graph suggests the roots $x = -1, 0, 1,$ and 5 . This can be confirmed by a straightforward calculation.

$$f(-1) = (-1)^4 - 5 \cdot (-1)^3 - (-1)^2 + 5 \cdot (-1) = 1 + 5 - 1 - 5 = 0,$$

$$f(0) = 0^4 - 5 \cdot 0^3 - 0^2 - 5 \cdot 0 = 0,$$

$$f(1) = 1^4 - 5 \cdot 1^3 - 1^2 + 5 \cdot 1 = 1 - 5 - 1 + 5 = 0,$$

$$f(5) = 5^4 - 5 \cdot 5^3 - 5^2 + 5 \cdot 5 = 125 - 125 - 25 + 25 = 0.$$

The roots $x = -1, 0, 1,$ and 5 are the only roots since f is of degree 4. The intervals of the solution for $f(x) > 0$ may be read off from the graph:

$$\text{solution set} = (-\infty, -1) \cup (0, 1) \cup (5, \infty)$$

(Notice that the roots $-1, 0, 1,$ and 5 are not included in the solution set since our inequality reads $f(x) > 0$ and *not* $f(x) \geq 0$.)

d) Again, we bring all terms to one side:

$$x^3 + 15x > 7x^2 + 9 \implies x^3 - 7x^2 + 15x - 9 > 0$$

(Here it does not matter whether we bring the terms to the right or the left side of the inequality sign! The resulting inequality is different, but the solution to the problem is the same.) With this, we now use the TI-84 to find the graph of the function $f(x) = x^3 - 7x^2 + 15x - 9$.

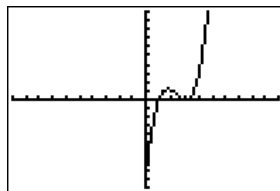

when $x > 3$ (the roots $x = 1$ and $x = 3$ are not included as solutions). We can write the solution set in several different ways:

$$\text{solution set} = \{x \mid 1 < x < 3 \text{ or } x > 3\} = \{x \mid 1 < x\} - \{3\},$$

or in interval notation:

$$\text{solution set} = (1, 3) \cup (3, \infty) = (1, \infty) - \{3\}.$$

e) If we set $f(x) = x^5 - 6x^4 - 26x^3 + 144x^2 - 47x - 210$ then we need to find those numbers x with $f(x) \leq 0$. We first graph f in the standard window.

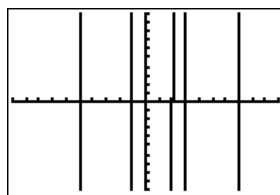

To get a better view of the graph, we rescale to an appropriate window:

```

WINDOW
Xmin=-10
Xmax=10
Xscl=1
Ymin=-1000
Ymax=1500
Yscl=1
↓Xres=1

```

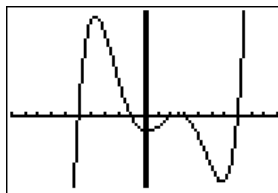

There appear to be three intervals, where $f(x) \leq 0$. To determine the exact numbers, we guess some of the roots from the graph. These would be $x = -5, -1, 2, 3, 7$. To confirm these roots, we calculate the following function values.

$$\begin{aligned} f(-5) &= (-5)^5 - 6 \cdot (-5)^4 - 26 \cdot (-5)^3 + 144 \cdot (-5)^2 - 47 \cdot (-5) - 210 \\ &= -3125 - 3750 + 3250 + 3600 + 235 - 210 = 0, \end{aligned}$$

$$\begin{aligned} f(-1) &= (-1)^5 - 6 \cdot (-1)^4 - 26 \cdot (-1)^3 + 144 \cdot (-1)^2 - 47 \cdot (-1) - 210 \\ &= -1 - 6 + 26 + 576 + 47 - 210 = 0, \end{aligned}$$

$$\begin{aligned} f(2) &= 2^5 - 6 \cdot 2^4 - 26 \cdot 2^3 + 144 \cdot 2^2 - 47 \cdot 2 - 210 \\ &= 32 - 96 - 208 + 576 - 94 - 210 = 0, \end{aligned}$$

$$f(3) = 3^5 - 6 \cdot 3^4 - 26 \cdot 3^3 + 144 \cdot 3^2 - 47 \cdot 3 - 210$$

$$\begin{aligned}
 &= 243 - 486 - 702 + 1296 - 141 - 210 = 0, \\
 f(7) &= 7^5 - 6 \cdot 7^4 - 26 \cdot 7^3 + 144 \cdot 7^2 - 47 \cdot 7 - 210 \\
 &= 16807 - 14406 - 8918 + 7056 - 329 - 210 = 0.
 \end{aligned}$$

Since $f(x)$ is of degree 5, we know that these are all of the roots of $f(x)$. The solution set for $f(x) \leq 0$ can be read from the graphs above:

$$\text{solution set} = (-\infty, -5] \cup [-1, 2] \cup [3, 7]$$

(Note again, that the roots are all included in the solution set.) \square

Polynomial inequalities come up, for example, when finding the domain of functions involving a square root, as we will show in the next example.

Example 12.3. Find the domain of the given functions.

$$\text{a) } f(x) = \sqrt{x^2 - 4} \qquad \text{b) } g(x) = \sqrt{x^3 - 5x^2 + 6x}$$

Solution. a) The domain of $f(x) = \sqrt{x^2 - 4}$ is given by all x for which the square root is non-negative. In other words the domain is given by numbers x with $x^2 - 4 \geq 0$. Graphing the function $y = x^2 - 4 = (x + 2)(x - 2)$, we see that this is precisely the case, when $x \leq -2$ or $x \geq 2$.

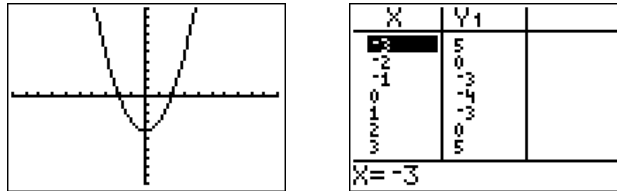

Therefore, the domain is $D_f = (-\infty, -2] \cup [2, \infty)$.

b) For the domain of $g(x) = \sqrt{x^3 - 5x^2 + 6x}$, we need find those x with $x^3 - 5x^2 + 6x \geq 0$. To this end, we graph $y = x^3 - 5x^2 + 6x$ and check for its roots.

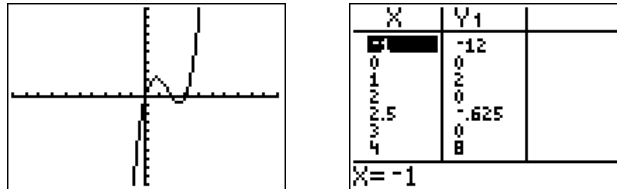

From the graph and table above, we calculate the roots of $y = x^3 - 5x^2 + 6x$ at $x = 0$, $x = 2$, and $x = 3$. Furthermore, the graph and table show that $x^3 - 5x^2 + 6x \geq 0$ precisely when $0 \leq x \leq 2$ or $3 \leq x$. The domain is therefore, $D_g = [0, 2] \cup [3, \infty)$. \square

12.2 Rational inequalities and absolute value inequalities

Rational inequalities are solved with the same three-step process that was used to solve the polynomial and absolute value inequalities before (see page 6). That is, in step 1, we find the solution of the corresponding equality, and then, in step 2, we use sample points of the graph to determine the intervals of the solution. Finally, in step 3, we check the endpoints of each interval.

Example 12.4. Solve for x .

$$\begin{array}{ll} \text{a) } \frac{x^2-5x+6}{x^2-5x} \geq 0 & \text{b) } \frac{5}{x-2} \leq 3 \\ \text{c) } \frac{4}{x+5} < \frac{3}{x-3} & \text{d) } |2x-3| > 7 \end{array}$$

Solution. a) Here is the graph of $\frac{x^2-5x+6}{x^2-5x}$ in the standard window.

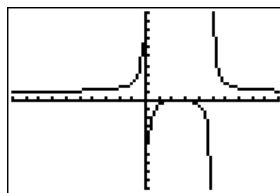

Factoring numerator and denominator, we can determine vertical asymptotes, holes, and x -intercepts.

$$\frac{x^2 - 5x + 6}{x^2 - 5x} = \frac{(x - 2)(x - 3)}{x(x - 5)}$$

The vertical asymptotes are at $x = 0$ and $x = 5$, the x -intercepts are at $x = 2$ and $x = 3$. Since for large x , the fraction reduces to $\frac{x^2}{x^2} = 1$, we see that the horizontal asymptote is at $y = 1$. Thus, $\frac{x^2-5x+6}{x^2-5x} \geq 0$ for $x < 0$ and $x > 5$. To see where the graph is ≥ 0 between 0 and 5, we zoom into the graph:

```

WINDOW
Xmin=-1
Xmax=6
Xscl=1
Ymin=-.3
Ymax=.3
Yscl=1
↓Xres=1

```

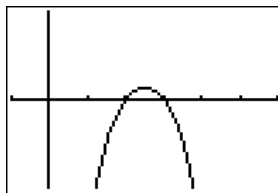

12.2. RATIONAL INEQUALITIES AND ABSOLUTE VALUE INEQUALITIES 177

Combining all of the above information, we obtain the solution set:

$$\text{solution set} = (-\infty, 0) \cup [2, 3] \cup (5, \infty)$$

Notice that the x -coordinate of the x -intercepts are $x = 2$ and $x = 3$ are included in the solution set, whereas the values $x = 0$ and $x = 5$ associated with the vertical asymptotes are not included since the fraction is not defined for $x = 0$ and $x = 5$.

b) To find the numbers x where $\frac{5}{x-2} \leq 3$, we can graph the two functions on the right and left of the inequality.

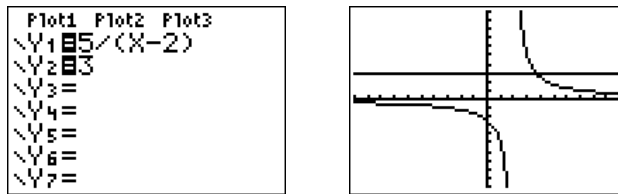

However, this can sometimes be confusing, and we recommend rewriting the inequality so that one side becomes zero. Then, we graph the function on the other side of the new inequality.

$$\begin{aligned} \frac{5}{x-2} \leq 3 &\implies \frac{5}{x-2} - 3 \leq 0 \implies \frac{5 - 3(x-2)}{x-2} \leq 0 \\ &\implies \frac{5 - 3x + 6}{x-2} \leq 0 \implies \frac{11 - 3x}{x-2} \leq 0 \end{aligned}$$

Therefore, we graph the function $f(x) = \frac{11-3x}{x-2}$.

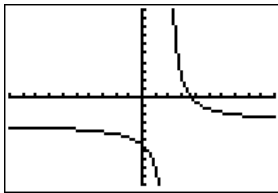

The vertical asymptote is $x = 2$, and the x -intercept found thus

$$11 - 3x = 0 \implies 11 = 3x \implies x = \frac{11}{3}$$

This together with the graph and the fact that f is undefined at 2 and $f(\frac{11}{2}) = 0$ gives the following solution set:

$$\text{solution set} = (-\infty, 2) \cup \left[\frac{11}{3}, \infty\right)$$

c) We want to find those numbers x for which $\frac{4}{x+5} < \frac{3}{x-3}$. One way to do this is given by graphing both functions $f_1(x) = \frac{4}{x+5}$ and $f_2(x) = \frac{3}{x-3}$, and by trying to determine where $f_1(x) < f_2(x)$. However this can sometimes be quite confusing, as the two graphs for f_1 and f_2 show below.

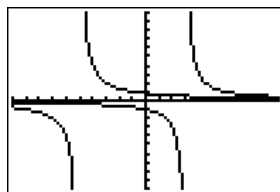

As before, we recommend rewriting the inequality so that one side of the inequality becomes zero:

$$\begin{aligned} \frac{4}{x+5} < \frac{3}{x-3} &\implies \frac{4}{x+5} - \frac{3}{x-3} < 0 \implies \frac{4(x-3) - 3(x+5)}{(x+5)(x-3)} < 0 \\ &\implies \frac{4x - 12 - 3x - 15}{(x+5)(x-3)} < 0 \implies \frac{x - 27}{(x+5)(x-3)} < 0 \end{aligned}$$

We therefore graph the function $f(x) = \frac{x-27}{(x+5)(x-3)}$.

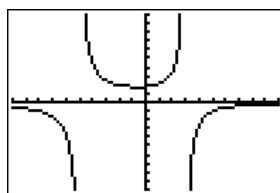

The vertical asymptotes of $f(x) = \frac{x-27}{(x+5)(x-3)}$ are $x = -5$ and $x = 3$. The x -intercept is $(27, 0)$. We see from the graph that $f(x) < 0$ for $x < -5$. To see the graph at $x > 3$, we zoom to the x -intercept at $x = 27$.

```

WINDOW
Xmin=24
Xmax=30
Xscl=1
Ymin=-.005
Ymax=.005
Yscl=1
↓Xres=1

```

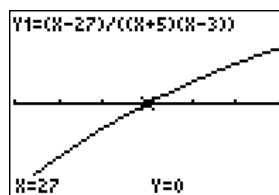

Therefore, the solution set is

$$\text{solution set} = \{x \mid x < -5, \text{ or } 3 < x < 27\} = (-\infty, -5) \cup (3, 27).$$

(The x -intercept $x = 27$ is not included in the solution set since the original equation had a “ $<$ ” and not “ \leq ” sign.)

d) To analyze $|2x - 3| > 7$, we graph the function $f(x) = |2x - 3| - 7$.

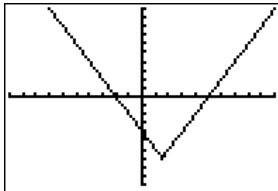

To see where $f(x) > 0$, we find the zeros of $f(x)$.

$$\begin{array}{l}
 |2x - 3| - 7 = 0 \implies |2x - 3| = 7 \implies 2x - 3 = \pm 7 \\
 \implies 2x - 3 = 7 \quad \left| \quad \implies 2x - 3 = -7 \right. \\
 \begin{array}{l} \text{(add 3)} \\ \text{(divide by 2)} \end{array} \implies 2x = 10 \quad \left| \quad \begin{array}{l} \text{(add 3)} \\ \text{(divide by 2)} \end{array} \implies 2x = -4 \right. \\
 \implies x = 5 \quad \left| \quad \implies x = -2 \right.
 \end{array}$$

Thus, we read off the solution set for $f(x) > 0$ from the graph.

$$\text{solution set} = (-\infty, -2) \cup (5, \infty)$$

□

12.3 Exercises

Exercise 12.1. Solve for x .

- | | |
|---------------------------------------|------------------------------------|
| a) $5x + 6 \leq 21$, | b) $3 + 4x > 10x$ |
| c) $2x + 8 \geq 6x + 24$, | d) $9 - 3x < 2x - 13$ |
| e) $-5 \leq 2x + 5 \leq 19$, | f) $15 > 7 - 2x \geq 1$ |
| g) $3x + 4 \leq 6x - 2 \leq 8x + 5$, | h) $5x + 2 < 4x - 18 \leq 7x + 11$ |

Exercise 12.2. Solve for x .

- | | |
|---------------------------------|--|
| a) $x^2 - 5x - 14 > 0$, | b) $x^2 - 2x \geq 35$ |
| c) $x^2 - 4 \leq 0$, | d) $x^2 + 3x - 3 < 0$ |
| e) $2x^2 + 2x \leq 12$, | f) $3x^2 < 2x + 1$ |
| g) $x^2 - 4x + 4 > 0$, | h) $x^3 - 2x^2 - 5x + 6 \geq 0$ |
| i) $x^3 + 4x^2 + 3x + 12 < 0$, | j) $-x^3 - 4x < -4x^2$ |
| k) $x^4 - 10x^2 + 9 \leq 0$, | l) $x^4 - 5x^3 + 5x^2 + 5x < 6$ |
| m) $x^4 - 5x^3 + 6x^2 > 0$, | n) $x^5 - 6x^4 + x^3 + 24x^2 - 20x \leq 0$ |

- o) $x^5 - 15x^4 + 85x^3 - 225x^2 + 274x - 120 \geq 0$,
p) $x^{11} - x^{10} + x - 1 \leq 0$

Exercise 12.3. Find the domain of the functions below.

- a) $f(x) = \sqrt{x^2 - 8x + 15}$ b) $f(x) = \sqrt{9x - x^3}$
c) $f(x) = \sqrt{(x-1)(4-x)}$ d) $f(x) = \sqrt{(x-2)(x-5)(x-6)}$
e) $f(x) = \frac{5}{\sqrt{6-2x}}$ f) $f(x) = \frac{1}{\sqrt{x^2-6x-7}}$

Exercise 12.4. Solve for x .

- a) $\frac{x-5}{2-x} > 0$ b) $\frac{4x-4}{x^2-4} \geq 0$ c) $\frac{x-2}{x^2-4x-5} < 0$ d) $\frac{x^2-9}{x^2-4} \geq 0$
e) $\frac{x-3}{x+3} \leq 4$ f) $\frac{1}{x+10} > 5$ g) $\frac{2}{x-2} \leq \frac{5}{x+1}$ h) $\frac{x^2}{x+4} \leq x$

Exercise 12.5. Solve for x .

- a) $|2x + 7| > 9$ b) $|6x + 2| < 3$
c) $|5 - 3x| \geq 4$ d) $|-x - 7| \leq 5$
e) $|1 - 8x| \geq 3$ f) $1 > \left|2 + \frac{x}{5}\right|$

Review of polynomials and rational functions

Exercise II.1. Divide the polynomials: $\frac{2x^3+x^2-9x-8}{2x+3}$

Exercise II.2. Find the remainder when dividing $x^3 + 3x^2 - 5x + 7$ by $x + 2$.

Exercise II.3. Which of the following is a factor of $x^{400} - 2x^{99} + 1$:

$$x - 1, \quad x + 1, \quad x - 0$$

Exercise II.4. Identify the polynomial with its graph.

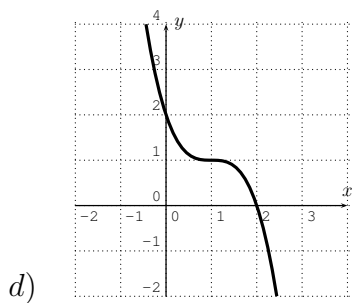
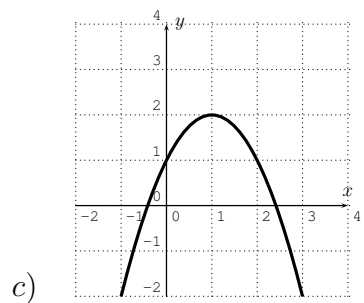
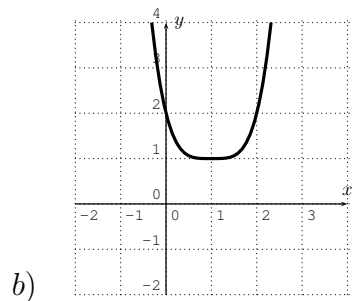
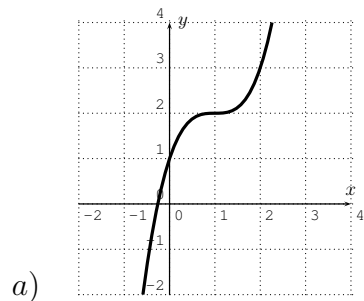

- i) $f(x) = -x^2 + 2x + 1$, graph: _____
- ii) $f(x) = -x^3 + 3x^2 - 3x + 2$, graph: _____
- iii) $f(x) = x^3 - 3x^2 + 3x + 1$, graph: _____
- iv) $f(x) = x^4 - 4x^3 + 6x^2 - 4x + 2$, graph: _____

Exercise II.5. Sketch the graph of the function:

$$f(x) = x^4 - 10x^3 - 0.01x^2 + 0.1x$$

- What is your viewing window?
- Find all roots, all maxima and all minima of the graph with the calculator.

Exercise II.6. Find all roots of $f(x) = x^3 + 6x^2 + 5x - 12$.

Use this information to *factor* $f(x)$ *completely*.

Exercise II.7. Find a polynomial of degree 3 whose roots are 0, 1, and 3, and so that $f(2) = 10$.

Exercise II.8. Find a polynomial of degree 4 with real coefficients, whose roots include -2 , 5 , and $3 - 2i$.

Exercise II.9. Let $f(x) = \frac{3x^2 - 12}{x^2 - 2x - 3}$. Sketch the graph of f . Include all vertical and horizontal asymptotes, all holes, and all x - and y -intercepts.

Exercise II.10. Solve for x :

a) $x^4 + 2x < 2x^3 + x^2$, b) $x^2 + 3x \geq 7$, c) $\frac{x+1}{x+4} \leq 2$

Part III

Exponential and logarithmic functions

Session 13

Exponential and logarithmic functions

13.1 Exponential functions and their graphs

We now consider functions that differ a great deal from polynomials and rational fractions in their complexity. More precisely, we will explore exponential and logarithmic functions from a function theoretic point of view. We start by recalling the definition of exponential functions and by studying their graphs.

Definition 13.1. A function f is called an **exponential function** if it is of the form

$$f(x) = c \cdot b^x$$

for some real number c and positive real number b . The constant b is called the **base**.

Example 13.2. Graph the functions

$$f(x) = 2^x, \quad g(x) = 3^x, \quad h(x) = 10^x, \quad k(x) = \left(\frac{1}{2}\right)^x, \quad l(x) = \left(\frac{1}{10}\right)^x.$$

First, we will graph the function $f(x) = 2^x$ by calculating the function values in a table and then plotting the points in the x - y -plane. We can calculate the values by hand, or simply use the table function of the calculator to find the function values.

$$f(0) = 2^0 = 1$$

$$\begin{aligned}
 f(1) &= 2^1 = 2 \\
 f(2) &= 2^2 = 4 \\
 f(3) &= 2^3 = 8 \\
 f(-1) &= 2^{-1} = 0.5 \\
 f(-2) &= 2^{-2} = 0.25
 \end{aligned}$$

```

Plot1 Plot2 Plot3
\Y1=2^X
\Y2=
\Y3=
\Y4=
\Y5=
\Y6=
    
```

X	Y1
-2	.25
-1	.5
0	1
1	2
2	4
4	16

X=-2

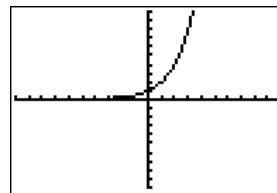

Similarly, we can calculate the table for the other functions g , h , k and l by entering the functions in the spots at Y2, Y3, Y4, and Y5. The values in the table for these functions can be seen by moving the cursor to the right with the  key.

```

Plot1 Plot2 Plot3
\Y2=3^X
\Y3=10^X
\Y4=(1/2)^X
\Y5=(1/10)^X
\Y6=
    
```

X	Y2	Y3
-2	.11111	.01
-1	.33333	.1
0	1	1
1	3	10
2	9	100
3	27	1000
4	81	10000

Y3=.01

X	Y4	Y5
-2	4	100
-1	2	10
0	1	1
1	.5	.1
2	.25	.01
3	.125	.001
4	.0625	1E-4

Y5=100

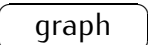
We can see the graphs by pressing the  key.

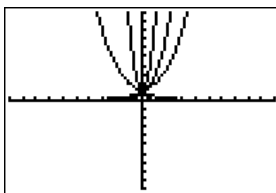

In order to see these graphs more clearly, we adjust the graphing window to a more appropriate size.

```

WINDOW
Xmin=-4
Xmax=4
Xscl=1
Ymin=-1
Ymax=10
Yscl=1
↓Xres=1
    
```

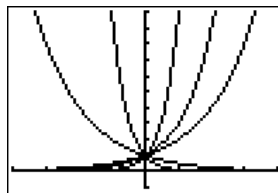

Since all these functions are graphed in the same window, it is difficult to associate the graphs with their corresponding functions. In order to distinguish between the graphs, we may use the TI-84 to draw the graphs in different line styles. In the function menu ($y=$), move the cursor to the left with \leftarrow , and press enter until the line becomes a thick line, or a dotted line, as desired. By moving the cursor down \downarrow , and pressing enter , we can adjust the line styles of the other graphs as well.

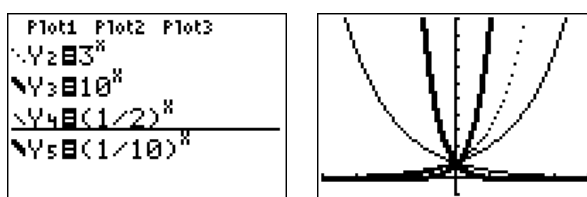

Note that the function k can also be written as

$$k(x) = \left(\frac{1}{2}\right)^x = (2^{-1})^x = 2^{-x},$$

and similarly, $l(x) = \left(\frac{1}{10}\right)^x = 10^{-x}$.

This example shows that the exponential function has the following properties.

Observation 13.3. The graph of the exponential function $f(x) = b^x$ with $b > 0$ and $b \neq 1$ has a horizontal asymptote at $y = 0$.

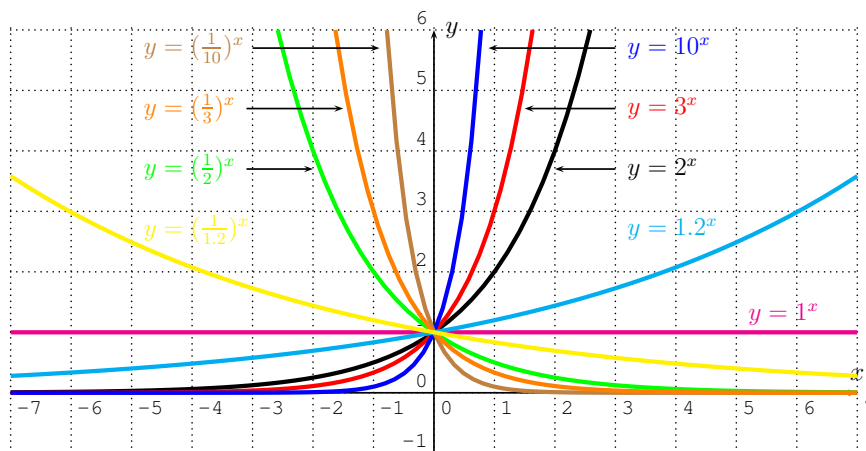

- If $b > 1$, then $f(x)$ approaches $+\infty$ when x approaches $+\infty$, and $f(x)$ approaches 0 when x approaches $-\infty$.
- If $0 < b < 1$, then $f(x)$ approaches 0 when x approaches $+\infty$, and $f(x)$ approaches $+\infty$ when x approaches $-\infty$.

An important base that we will frequently need to consider is the base of e , where e is the Euler number.

Definition 13.4. The **Euler number** e is an irrational number that is approximately

$$e = 2.718281828459045235 \dots$$

To be precise, we can define e as the number which is the horizontal asymptote of the function $f(x) = \left(1 + \frac{1}{x}\right)^x$ when x approaches $+\infty$.

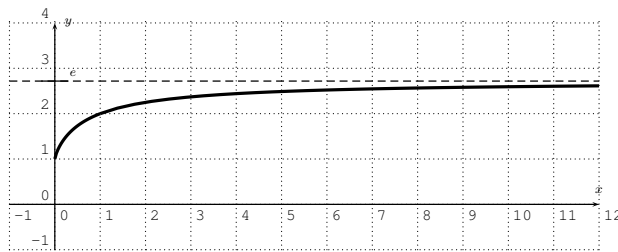

One can show that f has, indeed, a horizontal asymptote, and this limit is defined as e .

$$e := \lim_{x \rightarrow \infty} \left(1 + \frac{1}{x}\right)^x$$

Furthermore, one can show that the exponential function with base e has a similar limit expression.

$$e^r = \lim_{x \rightarrow \infty} \left(1 + \frac{r}{x}\right)^x \quad (13.1)$$

Alternatively, the Euler number and the exponential function with base e may also be defined using an infinite series, namely, $e^r = 1 + r + \frac{r^2}{1 \cdot 2} + \frac{r^3}{1 \cdot 2 \cdot 3} + \frac{r^4}{1 \cdot 2 \cdot 3 \cdot 4} + \dots$. These ideas will be explored further in a course in calculus.

Example 13.5. Graph the functions.

$$\text{a) } y = e^x, \quad \text{b) } y = e^{-x}, \quad \text{c) } y = e^{-x^2}, \quad \text{d) } y = \frac{e^x + e^{-x}}{2}$$

Solution. Using the calculator, we obtain the desired graphs. The exponential function $y = e^x$ may be entered via $\boxed{2\text{nd}} \boxed{\ln}$.

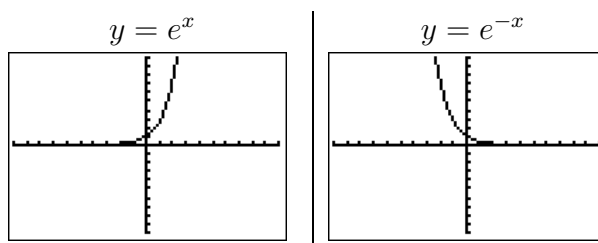

Note that the minus sign is entered in the last expression (and also in the following two functions) via the $\boxed{(-)}$ key.

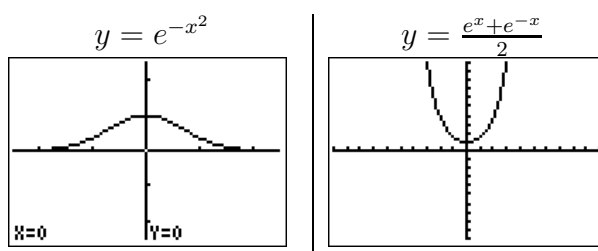

The last function $y = \frac{e^x + e^{-x}}{2}$ is called the *hyperbolic cosine*, and is denoted by $\cosh(x) = \frac{e^x + e^{-x}}{2}$. \square

We now study how different multiplicative factors c affect the shape of an exponential function.

Example 13.6. Graph the functions.

- a) $y = 2^x$, b) $y = 3 \cdot 2^x$, c) $y = (-3) \cdot 2^x$
 d) $y = 0.2 \cdot 2^x$, e) $y = (-0.2) \cdot 2^x$

Solution. We graph the functions in one viewing window.

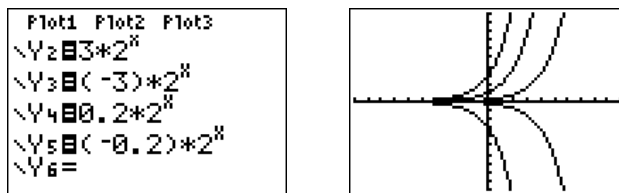

Here are the graphs of functions $f(x) = c \cdot 2^x$ for various choices of c .

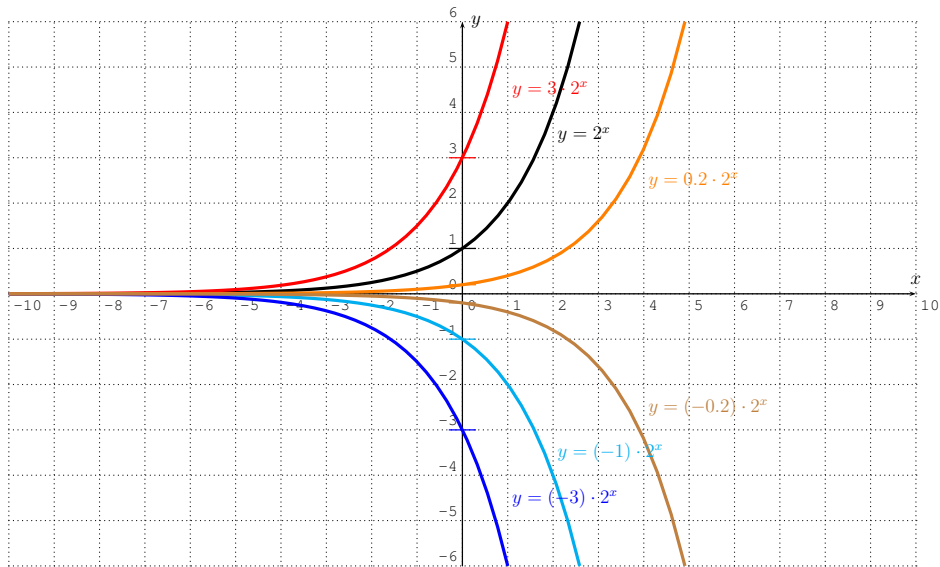

Note that for $f(x) = c \cdot 2^x$, the y -intercept is given at $f(0) = c$. □

Finally, we can combine our knowledge of graph transformations to study exponential functions that are shifted and stretched.

Example 13.7. Graph the functions.

$$\text{a) } y = 3^x - 5, \quad \text{b) } y = e^{x+4}, \quad \text{c) } y = \frac{1}{4} \cdot e^{x-3} + 2$$

Solution. The graphs are displayed below.

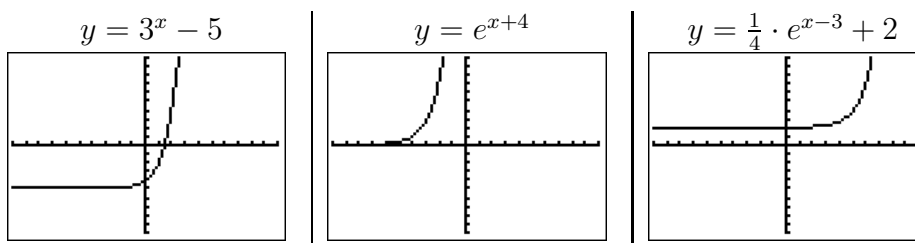

The first graph $y = 3^x - 5$ is the graph of $y = 3^x$ shifted down by 5.

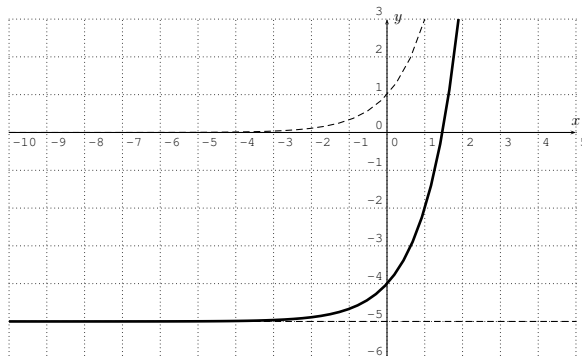

The graph of $y = e^{x+4}$ is the graph of $y = e^x$ shifted to the left by 4.

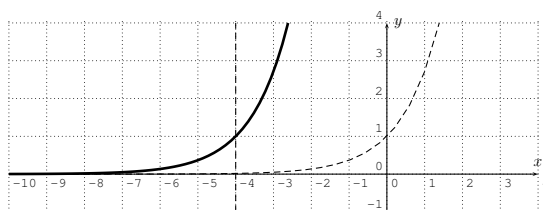

Finally, $y = \frac{1}{4}e^{x-3} + 2$ is the graph of $y = e^x$ shifted to the right by 3 (see the graph of $y = e^{x-3}$), then compressed by a factor 4 towards the x -axis (see the graph of $y = \frac{1}{4}e^{x-3}$), and then shifted up by 2.

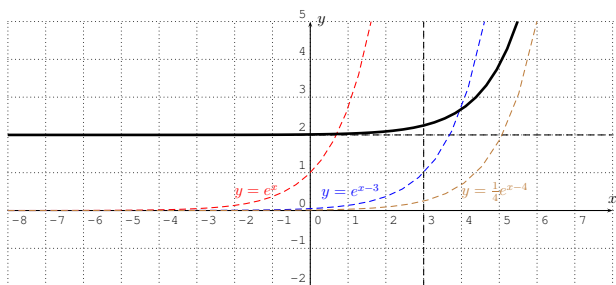

□

13.2 Logarithmic functions and their graphs

The logarithmic function is closely related to the exponential function. Specifically, the logarithm is the inverse function of the exponential function.

Definition 13.8. Let $0 < b \neq 1$ be a positive real number that is not equal to 1. For $x > 0$, the **logarithm of x with base b** is defined by the equivalence

$$\boxed{y = \log_b(x) \quad \Leftrightarrow \quad b^y = x} \quad (13.2)$$

For the particular base $b = 10$ we use the short form

$$\boxed{\log(x) := \log_{10}(x)}$$

For the particular base $b = e$, where $e \approx 2.71828$ is the Euler number, we call the logarithm with base e the **natural logarithm**, and write

$$\boxed{\ln(x) := \log_e(x)}$$

The **logarithmic function** is the function $y = \log_b(x)$ with domain $D = \{x \in \mathbb{R} | x > 0\}$ of all positive real numbers, and range $R = \mathbb{R}$ of all real numbers. It is the inverse of the exponential function $y = b^x$ with base b .

Example 13.9. Rewrite the equation as a logarithmic equation.

$$\begin{array}{ll} \text{a) } 3^4 = 81, & \text{b) } 10^3 = 1000, \\ \text{c) } e^x = 17, & \text{d) } 2^{7-a} = 53. \end{array}$$

Solution. We can immediately apply equation (13.2). For part (a), we have $b = 3$, $y = 4$, and $x = 81$. Therefore we have:

$$3^4 = 81 \quad \Leftrightarrow \quad \log_3(81) = 4$$

Similarly, we obtain the solutions for (b), (c), and (d).

$$\begin{array}{ll} \text{b) } 10^3 = 1000 & \Leftrightarrow \log(1000) = 3 \\ \text{c) } e^x = 17 & \Leftrightarrow \ln(17) = x \\ \text{d) } 2^{7-a} = 53 & \Leftrightarrow \log_2(53) = 7-a \end{array}$$

□

Example 13.10. Evaluate the expression by rewriting it as an exponential expression.

$$\begin{array}{llll} \text{a) } \log_2(16), & \text{b) } \log_5(125), & \text{c) } \log_{13}(1), & \text{d) } \log_4(4) \\ \text{e) } \log(10,000), & \text{f) } \log(0.001), & \text{g) } \ln(e^7), & \text{h) } \log_b(b^x) \end{array}$$

Solution. a) If we set $y = \log_2(16)$, then this is equivalent to $2^y = 16$. Since, clearly, $2^4 = 16$, we see that $y = 4$. Therefore, we have $\log_2(16) = 4$.

$$\begin{aligned} \text{b) } \log_5(125) = y & \Leftrightarrow 5^y = 125 \\ & \underset{\substack{\text{(since } 5^3=125)}{\implies}}{\implies} 3 = y = \log_5(125) \end{aligned}$$

$$\begin{aligned} \text{c) } \log_{13}(1) = y & \Leftrightarrow 13^y = 1 \\ & \underset{\substack{\text{(since } 13^0=1)}{\implies}}{\implies} 0 = y = \log_{13}(1) \end{aligned}$$

$$\begin{aligned} \text{d) } \log_4(4) = y & \Leftrightarrow 4^y = 4 \\ & \underset{\substack{\text{(since } 4^1=4)}{\implies}}{\implies} 1 = y = \log_4(4) \end{aligned}$$

$$\begin{aligned} \text{e) } \log(100,000) = y & \Leftrightarrow 10^y = 100,000 \\ & \underset{\substack{\text{(since } 10^5=100,000)}{\implies}}{\implies} 5 = y = \log(100,000) \end{aligned}$$

$$\begin{aligned} \text{f) } \log(0.001) = y & \Leftrightarrow 10^y = 0.001 \\ & \underset{\substack{\text{(since } 10^{-3}=0.001)}{\implies}}{\implies} -3 = y = \log(0.001) \end{aligned}$$

$$\text{g) } \ln(e^7) = y \quad \Leftrightarrow \quad e^y = e^7 \quad \implies \quad 7 = y = \ln(e^7)$$

$$\text{h) } \log_b(b^x) = y \quad \Leftrightarrow \quad b^y = b^x \quad \implies \quad x = y = \log_b(b^x)$$

In fact, the last example, in which we obtained $\log_b(b^x) = x$, combines all of the previous examples. \square

In the previous example (in parts (c), (d), and (h)), we were able to find certain elementary logarithms. We record these in the next observation.

Observation 13.11. We have the elementary logarithms:

$$\boxed{\log_b(b^x) = x} \quad \boxed{\log_b(b) = 1} \quad \boxed{\log_b(1) = 0} \quad (13.3)$$

In general, when the argument is not a power of the base, we can use the calculator to approximate the values of a logarithm via the formulas:

$$\boxed{\log_b(x) = \frac{\log(x)}{\log(b)}} \quad \text{or} \quad \boxed{\log_b(x) = \frac{\ln(x)}{\ln(b)}} \quad (13.4)$$

The last two formulas will be proved in proposition 14.1 below. For now, we want to show how they can be used to calculate any logarithmic expression with the calculator.

Example 13.12. Calculate: a) $\log_3(13)$, b) $\log_{2.34}(98.765)$

Solution. We calculate $\log_3(13)$ by using the first formula in (13.4).

$$\log_3(13) = \frac{\log(13)}{\log(3)} \approx 2.335$$

Alternatively, we can also calculate this with the second formula in (13.4).

$$\log_3(13) = \frac{\ln(13)}{\ln(3)} \approx 2.335$$

For part (b) we have $\log_{2.34}(98.765) = \frac{\log(98.765)}{\log(2.34)} \approx 5.402$. □

We also want to gain an understanding of the graph of a logarithmic function. Consider the graph of $y = 2^x$ from the previous section. Recall that the graph of the inverse of a function is the reflection of the graph of the function about the diagonal line $y = x$. So in this case we have:

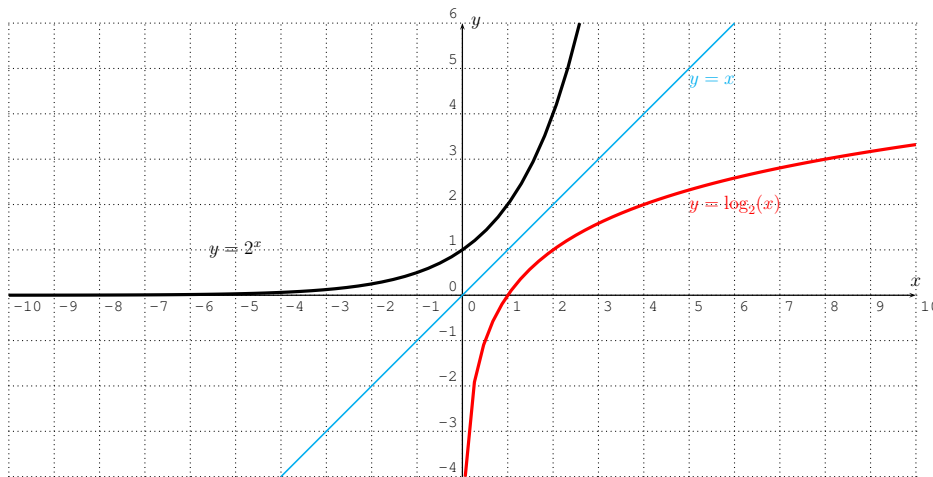

The graph can also be obtained using a graphing calculator.

Example 13.13.

- Graph the functions $f(x) = \ln(x)$, $g(x) = \log(x)$, $h(x) = \log_2(x)$, and $k(x) = \log_{0.5}(x)$. What are the domains of f , g , h , and k ? How do these functions differ?
- Graph the function $p(x) = -3 \cdot \ln(x) + 4$. What is the domain of p ?
- Graph the function $q(x) = \ln(5 - x)$. What is the domain of q ?
- Graph the function $r(x) = \log_7(2x + 8)$. What is the domain of r ?

Solution. a) We know from the definition that the domain of f , g , and h is all real positive numbers, $D_f = D_g = D_h = D_k = \{x|x > 0\}$. The functions f and g can immediately be entered into the calculator. The standard window gives the following graphs.

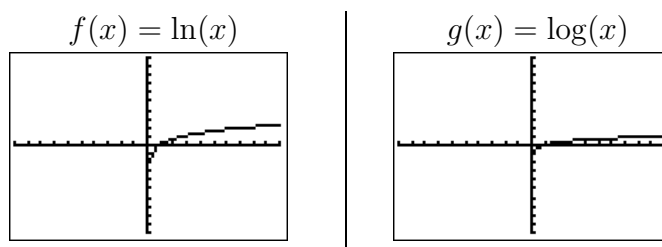

Note that we can rewrite $g(x)$, $h(x)$, and $k(x)$ as a constant times $f(x)$:

$$g(x) = \log(x) = \log_{10}(x) = \frac{\ln(x)}{\ln(10)} = \frac{1}{\ln(10)} \cdot f(x)$$

$$h(x) = \log_2(x) = \frac{\ln(x)}{\ln(2)} = \frac{1}{\ln(2)} \cdot f(x)$$

$$k(x) = \log_{0.5}(x) = \frac{\ln(x)}{\ln(0.5)} = \frac{1}{\ln(0.5)} \cdot f(x)$$

Since $\frac{1}{\ln(10)} \approx 0.434 < 1$, we see that the graph of g is that of f compressed towards the x -axis by a factor $\frac{1}{\ln(10)}$. Similarly, $\frac{1}{\ln(2)} \approx 1.443 > 1$, so that the graph of h is that of f stretched away from the x -axis by a factor $\frac{1}{\ln(2)}$. Finally, $\frac{1}{\ln(0.5)} \approx -1.443$, or more precisely, $\frac{1}{\ln(0.5)} = \frac{1}{\ln(2^{-1})} = -\frac{1}{\ln(2)}$, so that the graph of k is that of h reflected about the x -axis.

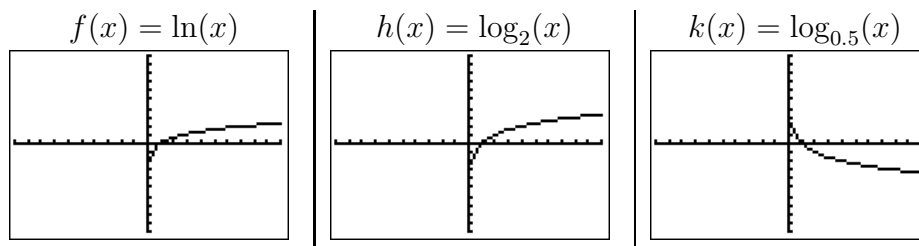

Note that all these graphs have a common x -intercept at $x = 1$:

$$f(1) = g(1) = h(1) = k(1) = 0$$

To visualize the differences between the graphs, we graph them together in one coordinate system.

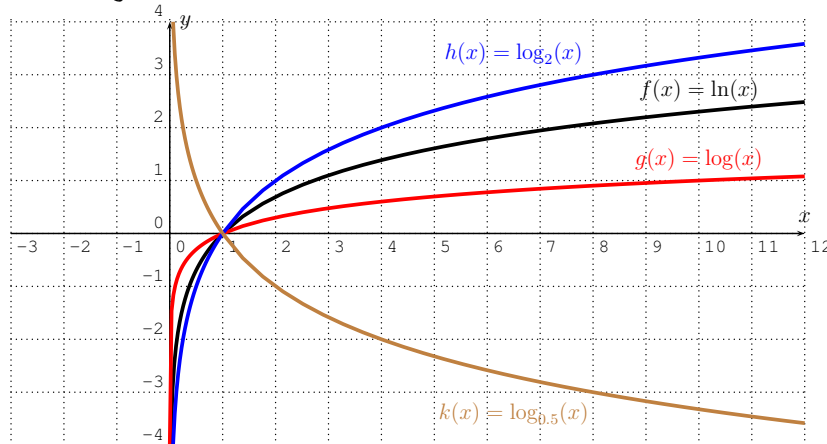

b) Using our knowledge of transformations of graphs, we expect that $p(x) = -3 \cdot \ln(x) + 4$ is that of $y = \ln(x)$ reflected and stretched away from the x -axis (by a factor 3), and then shifted up by 4. The stretched and reflected graph is in the middle below, whereas the graph of the shifted function p is on the right below.

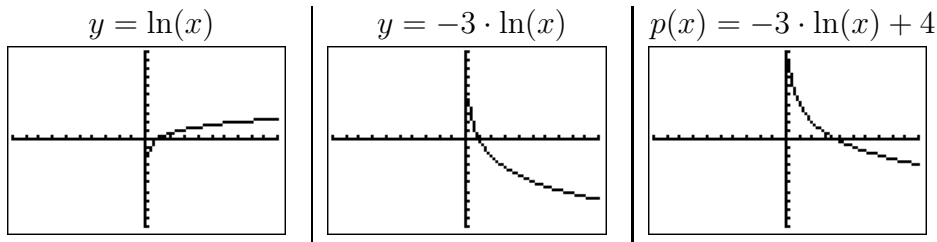

The domain consist of numbers x for which the $\ln(x)$ is defined, that is, $D_p = \{x|x > 0\}$.

c) To determine the domain of $q(x) = \ln(5 - x)$, we have to see for which x the logarithm has a positive argument. More precisely, we need $5 - x > 0$, that is, $5 > x$, so that the domain is $D_q = \{x|x < 5\}$.

The calculator displays the following graph.

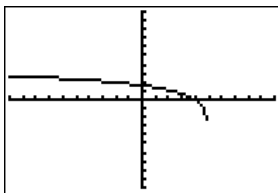

Note that the graph, as displayed by the calculator, appears to end at a point that is approximately at $(5, -2.5)$. However, the actual graph of the logarithm *does not* stop at any point, since it has a vertical asymptote at $x = 5$, that is, the graph approaches $-\infty$ as x approaches 5. The calculator only displays an approximation, which may be misleading since this approximation is determined by the window size and the size of each pixel. The graph would therefore look as follows.

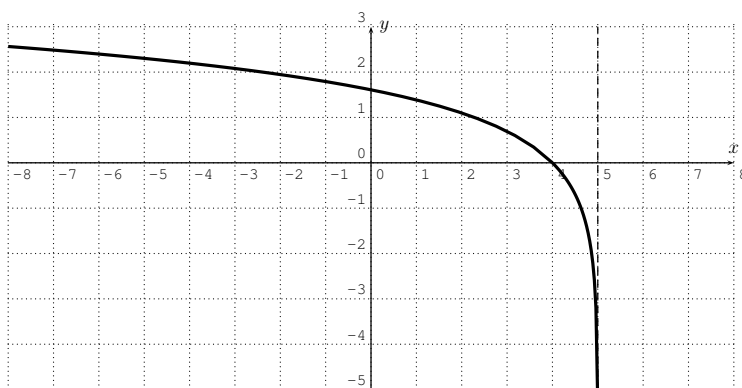

d) The domain of $r(x) = \log_7(2x+8)$ consists of those numbers x for which the argument of the logarithm is positive.

$$2x + 8 > 0 \xrightarrow{\text{(subtract 8)}} 2x > -8 \xrightarrow{\text{(divide by 2)}} x > -4$$

Therefore, the domain is $D_r = \{x | x > -4\}$. To graph the function $r(x) = \log_7(2x+8)$, we can enter $r(x) = \frac{\ln(2x+8)}{\ln(7)}$ into the calculator. The graph looks as follows.

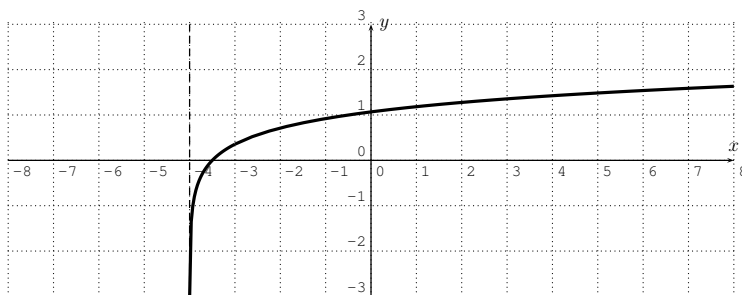

□

The previous example analyzes the graph of the logarithm function. Here is the summary.

Observation 13.14. The graph of a logarithmic function $y = \log_b(x)$ with base b is that of the natural logarithm $y = \ln(x)$ stretched away from the x -axis, or compressed towards the x -axis when $b > 1$. When $0 < b < 1$, the graph is furthermore reflected about the x -axis.

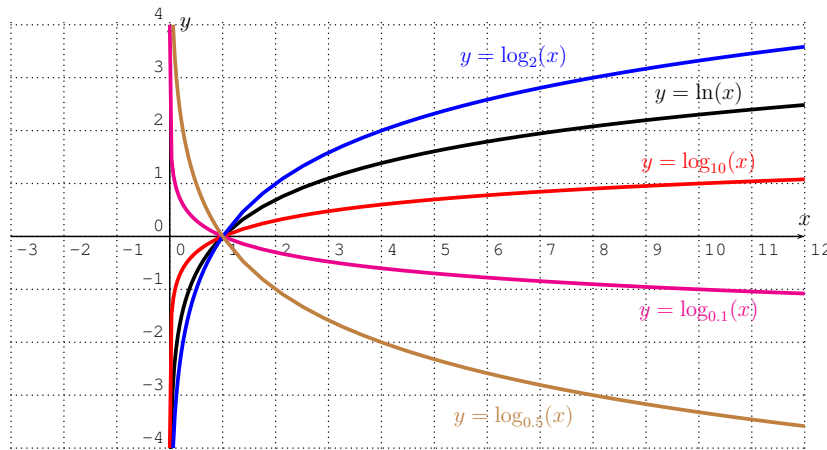

The graph $y = \log_b(x)$ has domain $D = \{x|x > 0\}$, and a vertical asymptote at $x = 0$. There is *no* horizontal asymptote, as $f(x)$ approaches $+\infty$ when x approaches $+\infty$ for $b > 1$, and $f(x)$ approaches $-\infty$ when x approaches $+\infty$ for $0 < b < 1$. Finally, there is an x -intercept at $x = 1$.

13.3 Exercises

Exercise 13.1. Graph the following functions with the calculator.

- a) $y = 5^x$ b) $y = 1.01^x$ c) $y = \left(\frac{1}{3}\right)^x$ d) $y = 0.97^x$
 e) $y = 3^{-x}$ f) $y = \left(\frac{1}{3}\right)^{-x}$ g) $y = e^{x^2}$ h) $y = 0.01^x$
 i) $y = 1^x$ j) $y = e^x + 1$ k) $y = \frac{e^x - e^{-x}}{2}$ l) $y = \frac{e^x - e^{-x}}{e^x + e^{-x}}$

The last two functions are known as the *hyperbolic sine*, $\sinh(x) = \frac{e^x - e^{-x}}{2}$, and the *hyperbolic tangent*, $\tanh(x) = \frac{e^x - e^{-x}}{e^x + e^{-x}}$. Recall that the *hyperbolic cosine* $\cosh(x) = \frac{e^x + e^{-x}}{2}$ was already graphed in example 13.5.

Exercise 13.2. Graph the given function. Describe how the graph is obtained by a transformation from the graph of an exponential function $y = b^x$ (for

appropriate base b).

$$\begin{array}{lll} \text{a) } y = 0.1 \cdot 4^x & \text{b) } y = 3 \cdot 2^x & \text{c) } y = (-1) \cdot 2^x \\ \text{d) } y = 0.006 \cdot 2^x & \text{e) } y = e^{-x} & \text{f) } y = e^{-x} + 1 \\ \text{g) } y = \left(\frac{1}{2}\right)^x + 3 & \text{h) } y = 2^{x-4} & \text{i) } y = 2^{x+1} - 6 \end{array}$$

Exercise 13.3. Use the definition of the logarithm to write the given equation as an equivalent logarithmic equation.

$$\begin{array}{llll} \text{a) } 4^2 = 16 & \text{b) } 2^8 = 256 & \text{c) } e^x = 7 & \text{d) } 10^{-1} = 0.1 \\ \text{e) } 3^x = 12 & \text{f) } 5^{7 \cdot x} = 12 & \text{g) } 3^{2a+1} = 44 & \text{h) } \left(\frac{1}{2}\right)^{\frac{x}{h}} = 30 \end{array}$$

Exercise 13.4. Evaluate the following expressions *without* using a calculator.

$$\begin{array}{llll} \text{a) } \log_7(49) & \text{b) } \log_3(81) & \text{c) } \log_2(64) & \text{d) } \log_{50}(2,500) \\ \text{e) } \log_2(0.25) & \text{f) } \log(1,000) & \text{g) } \ln(e^4) & \text{h) } \log_{13}(13) \\ \text{i) } \log(0.1) & \text{j) } \log_6\left(\frac{1}{36}\right) & \text{k) } \ln(1) & \text{l) } \log_{\frac{1}{2}}(8) \end{array}$$

Exercise 13.5. Using a calculator, approximate the following expressions to the nearest thousandth.

$$\text{a) } \log_3(50) \quad \text{b) } \log_3(12) \quad \text{c) } \log_{17}(0.44) \quad \text{d) } \log_{0.34}(200)$$

Exercise 13.6. State the domain of the function f and sketch its graph.

$$\begin{array}{ll} \text{a) } f(x) = \log(x) & \text{b) } f(x) = \log(x + 7) \\ \text{c) } f(x) = \ln(x + 5) - 1 & \text{d) } f(x) = \ln(3x - 6) \\ \text{e) } f(x) = 2 \cdot \log(x + 4) & \text{f) } f(x) = -4 \cdot \log(x + 2) \\ \text{g) } f(x) = \log_3(x - 5) & \text{h) } f(x) = -\ln(x - 1) + 3 \\ \text{i) } f(x) = \log_{0.4}(x) & \text{j) } f(x) = \log_3(-5x) - 2 \\ \text{k) } f(x) = \log|x| & \text{l) } f(x) = \log|x + 2| \end{array}$$

Session 14

Properties of exponential and logarithmic functions

14.1 Algebraic properties of exponential and logarithmic functions

We recall some of the main properties of the exponential function:

$$\begin{array}{l} b^{x+y} = b^x \cdot b^y \\ b^{x-y} = \frac{b^x}{b^y} \\ (b^x)^n = b^{nx} \end{array} \quad (14.1)$$

Writing the above properties in terms of $f(x) = b^x$ we have $f(x+y) = f(x)f(y)$, $f(x-y) = f(x)/f(y)$, and $f(nx) = f(x)^n$.

Due to the fact that the logarithm is the inverse function of the exponential, we have corresponding properties whose proof follows:

Proposition 14.1. The logarithm behaves well with respect to products, quotients, and exponentiation. Indeed, for all positive real numbers $0 < b \neq 1$, $x > 0$, $y > 0$, and real numbers n , we have:

$$\begin{array}{l} \log_b(x \cdot y) = \log_b(x) + \log_b(y) \\ \log_b\left(\frac{x}{y}\right) = \log_b(x) - \log_b(y) \\ \log_b(x^n) = n \cdot \log_b(x) \end{array} \quad (14.2)$$

In terms of the logarithmic function $g(x) = \log_b(x)$, the properties in the table above can be written: $g(xy) = g(x) + g(y)$, $g(x/y) = g(x) - g(y)$, and $g(x^n) = n \cdot g(x)$.

Furthermore, for another positive real number $0 < a \neq 1$, we have the *change of base formula*:

$$\boxed{\log_b(x) = \frac{\log_a(x)}{\log_a(b)}} \quad (14.3)$$

In particular, we have the formulas from equation (13.4) on page 192 when taking the base $a = 10$ and $a = e$:

$$\log_b(x) = \frac{\log(x)}{\log(b)} \quad \text{and} \quad \log_b(x) = \frac{\ln(x)}{\ln(b)}$$

Proof. We start with the first formula $\log_b(x \cdot y) = \log_b(x) + \log_b(y)$. If we call $u = \log_b(x)$ and $v = \log_b(y)$, then the equivalent exponential formulas are $b^u = x$ and $b^v = y$. With this, we have

$$x \cdot y = b^u \cdot b^v = b^{u+v}.$$

Rewriting this in logarithmic form, we obtain

$$\log_b(x \cdot y) = u + v = \log_b(x) + \log_b(y).$$

This is what we needed to show.

Next, we prove the formula $\log_b(\frac{x}{y}) = \log_b(x) - \log_b(y)$. We abbreviate $u = \log_b(x)$ and $v = \log_b(y)$ as before, and their exponential forms are $b^u = x$ and $b^v = y$. Therefore, we have

$$\frac{x}{y} = \frac{b^u}{b^v} = b^{u-v}.$$

Rewriting this again in logarithmic form, we obtain the desired result.

$$\log_b\left(\frac{x}{y}\right) = u - v = \log_b(x) - \log_b(y)$$

For the third formula, $\log_b(x^n) = n \cdot \log_b(x)$, we write $u = \log_b(x)$, that is in exponential form $b^u = x$. Then:

$$x^n = (b^u)^n = b^{n \cdot u} \implies \log_b(x^n) = n \cdot u = n \cdot \log_b(x)$$

For the last formula (14.3), we write $u = \log_b(x)$, that is, $b^u = x$. Applying the logarithm with base a to $b^u = x$ gives $\log_a(b^u) = \log_a(x)$. As we have just shown before, $\log_a(b^u) = u \cdot \log_a(b)$. Combining these identities with the initial definition $u = \log_b(x)$, we obtain

$$\log_a(x) = \log_a(b^u) = u \cdot \log_a(b) = \log_b(x) \cdot \log_a(b)$$

Dividing both sides by $\log_a(b)$ gives the result $\frac{\log_a(x)}{\log_a(b)} = \log_b(x)$. □

Example 14.2. Combine the terms using the properties of logarithms so as to write as one logarithm.

$$\begin{array}{ll} \text{a) } \frac{1}{2} \ln(x) + \ln(y) & \text{b) } \frac{2}{3}(\log(x^2y) - \log(xy^2)) \\ \text{c) } 2 \ln(x) - \frac{1}{3} \ln(y) - \frac{7}{5} \ln(z) & \text{d) } 5 + \log_2(a^2 - b^2) - \log_2(a + b) \end{array}$$

Solution. Recall that a fractional exponent can also be rewritten with an n th root.

$$\boxed{x^{\frac{1}{2}} = \sqrt{x}} \quad \text{and} \quad \boxed{x^{\frac{1}{n}} = \sqrt[n]{x}} \quad \implies \quad x^{\frac{p}{q}} = (x^p)^{\frac{1}{q}} = \sqrt[q]{x^p}$$

We apply the rules from proposition 14.1.

$$\begin{array}{l} \text{a) } \frac{1}{2} \ln(x) + \ln(y) = \ln(x^{\frac{1}{2}}) + \ln(y) = \ln(x^{\frac{1}{2}}y) = \ln(\sqrt{x} \cdot y) \\ \text{b) } \frac{2}{3}(\log(x^2y) - \log(xy^2)) = \frac{2}{3} \left(\log \left(\frac{x^2y}{xy^2} \right) \right) = \frac{2}{3} \left(\log \left(\frac{x}{y} \right) \right) \\ \quad = \log \left(\left(\frac{x}{y} \right)^{\frac{2}{3}} \right) = \log \left(\sqrt[3]{\frac{x^2}{y^2}} \right) \\ \text{c) } 2 \ln(x) - \frac{1}{3} \ln(y) - \frac{7}{5} \ln(z) = \ln(x^2) - \ln(\sqrt[3]{y}) - \ln(\sqrt[5]{z^7}) = \ln \left(\frac{x^2}{\sqrt[3]{y} \cdot \sqrt[5]{z^7}} \right) \\ \text{d) } 5 + \log_2(a^2 - b^2) - \log_2(a + b) = \log_2(2^5) + \log_2(a^2 - b^2) - \log_2(a + b) \\ \quad = \log_2 \left(\frac{2^5 \cdot (a^2 - b^2)}{a + b} \right) = \log_2 \left(\frac{32 \cdot (a+b)(a-b)}{a+b} \right) = \log_2(32 \cdot (a - b)) \end{array}$$

□

Example 14.3. Write the expressions in terms of elementary logarithms $u = \log_b(x)$, $v = \log_b(y)$, and, in part (c), also $w = \log_b(z)$. Assume that $x, y, z > 0$.

$$\text{a) } \ln(\sqrt{x^5} \cdot y^2), \quad \text{b) } \log \left(\sqrt{\sqrt{x} \cdot y^3} \right) \quad \text{c) } \log_2 \left(\sqrt[3]{\frac{x^2}{y\sqrt{z}}} \right).$$

Solution. In a first step, we rewrite the expression with fractional exponents, and then apply the rules from proposition 14.1.

$$\begin{array}{l} \text{a) } \ln(\sqrt{x^5} \cdot y^2) = \ln(x^{\frac{5}{2}} \cdot y^2) = \ln(x^{\frac{5}{2}}) + \ln(y^2) \\ \quad = \frac{5}{2} \ln(x) + 2 \ln(y) = \frac{5}{2}u + 2v \\ \text{b) } \log \left(\sqrt{\sqrt{x} \cdot y^3} \right) = \log \left(\left(x^{\frac{1}{2}}y^3 \right)^{\frac{1}{2}} \right) = \frac{1}{2} \log \left(x^{\frac{1}{2}}y^3 \right) \\ \quad = \frac{1}{2} \left(\log(x^{\frac{1}{2}}) + \log(y^3) \right) = \frac{1}{2} \left(\frac{1}{2} \log(x) + 3 \log(y) \right) \\ \quad = \frac{1}{4} \log(x) + \frac{3}{2} \log(y) = \frac{1}{4}u + \frac{3}{2}v \end{array}$$

$$\begin{aligned}
\text{c) } \log_2 \left(\sqrt[3]{\frac{x^2}{y\sqrt{z}}} \right) &= \log_2 \left(\left(\frac{x^2}{y \cdot z^{\frac{1}{2}}} \right)^{\frac{1}{3}} \right) = \frac{1}{3} \log_2 \left(\frac{x^2}{y \cdot z^{\frac{1}{2}}} \right) \\
&= \frac{1}{3} \left(\log_2(x^2) - \log_2(y) - \log_2(z^{\frac{1}{2}}) \right) \\
&= \frac{1}{3} \left(2 \log_2(x) - \log_2(y) - \frac{1}{2} \log_2(z) \right) \\
&= \frac{2}{3} \log_2(x) - \frac{1}{3} \log_2(y) - \frac{1}{6} \log_2(z) \\
&= \frac{2}{3}u - \frac{1}{3}v - \frac{1}{6}w
\end{aligned}$$

□

14.2 Solving exponential and logarithmic equations

We can solve exponential and logarithmic equations by applying logarithms and exponentials. Since the exponential and logarithmic functions are invertible (they are inverses of each other), applying these operations can also be reversed. In short we have observed that

Observation 14.4.

$$\begin{aligned}
x = y &\implies b^x = b^y, & \text{and} & & b^x = b^y &\implies x = y \\
x = y &\implies \log_b(x) = \log_b(y), & \text{and} & & \log_b(x) = \log_b(y) &\implies x = y
\end{aligned}$$

We can use the above implications whenever we have a common basis, or when we can convert the terms to a common basis.

Example 14.5. Solve for x .

$$\begin{array}{ll}
\text{a) } 2^{x+7} = 32 & \text{b) } 10^{2x-8} = 0.01 \\
\text{c) } 7^{2x-3} = 7^{5x+4} & \text{d) } 5^{3x+1} = 25^{4x-7} \\
\text{e) } \ln(3x-5) = \ln(x-1) & \text{f) } \log_2(x+5) = \log_2(x+3) + 4 \\
\text{g) } \log_6(x) + \log_6(x+4) = \log_6(5) & \text{h) } \log_3(x-2) + \log_3(x+6) = 2
\end{array}$$

Solution. In these examples, we can always write both sides of the equation as an exponential expression with the same base.

$$\begin{aligned}
\text{a) } 2^{x+7} = 32 &\implies 2^{x+7} = 2^5 \implies x+7 = 5 \implies x = -2 \\
\text{b) } 10^{2x-8} = 0.01 &\implies 10^{2x-8} = 10^{-2} \implies 2x-8 = -2 \\
&\implies 2x = 6 \implies x = 3
\end{aligned}$$

14.2. SOLVING EXPONENTIAL AND LOGARITHMIC EQUATIONS 203

Here it is useful to recall the powers of 10, which were also used to solve the equation above.

$10^3 = 1,000$ $10^2 = 100$ $10^1 = 10$ $10^0 = 1$ $10^{-1} = 0.1$ $10^{-2} = 0.01$ $10^{-3} = 0.001$	In general ($n \geq 1$):	$\left\{ \begin{array}{l} 10^n = \underbrace{100 \cdots 00}_{n \text{ zeros}} \\ 10^{-n} = \underbrace{0.0 \cdots 001}_{n \text{ zeros}} \end{array} \right.$
---	----------------------------	---

c) $7^{2x-3} = 7^{5x+4} \implies 2x - 3 = 5x + 4 \xrightarrow{(-5x+3)} -3x = 7$
 $\implies x = -\frac{7}{3}$

d) $5^{3x+1} = 25^{4x-7} \implies 5^{3x+1} = 5^{2 \cdot (4x-7)} \implies 3x + 1 = 2 \cdot (4x - 7)$
 $\implies 3x + 1 = 8x - 14 \xrightarrow{(-8x-1)} -5x = -15$
 $\implies x = 3$

By a similar reasoning we can solve equations involving logarithms whenever the bases coincide.

e) $\ln(3x - 5) = \ln(x - 1) \implies 3x - 5 = x - 1 \xrightarrow{(-x+5)} 2x = 4$
 $\implies x = 2$

For part (f), we have to solve $\log_2(x+5) = \log_2(x+3)+4$. To combine the right-hand side, recall that 4 can be written as a logarithm, $4 = \log_2(2^4) = \log_2 16$. With this remark we can now solve the equation for x .

$$\begin{aligned} \log_2(x + 5) = \log_2(x + 3) + 4 &\implies \log_2(x + 5) = \log_2(x + 3) + \log_2(16) \\ \implies \log_2(x + 5) = \log_2(16 \cdot (x + 3)) &\implies x + 5 = 16(x + 3) \\ \implies x + 5 = 16x + 48 \xrightarrow{(-16x-5)} &-15x = 43 \implies x = -\frac{43}{15} \end{aligned}$$

Next, in part (g), we start by combining the logarithms.

$$\log_6(x) + \log_6(x + 4) = \log_6(5) \implies \log_6(x(x + 4)) = \log_6(5)$$

$$\begin{aligned}
&\stackrel{\text{remove } \log_6}{\implies} x(x+4) = 5 \\
&\implies x^2 + 4x - 5 = 0 \\
&\implies (x+5)(x-1) = 0 \\
&\implies x = -5 \text{ or } x = 1
\end{aligned}$$

Since the equation became a quadratic equation, we ended up with two possible solutions $x = -5$ and $x = 1$. However, since $x = -5$ would give a negative value inside a logarithm in our original equation $\log_6(x) + \log_6(x+4) = \log_6(5)$, we need to exclude this solution. The only solution is $x = 1$.

Similarly we can solve the next part, using that $2 = \log_3(3^2)$:

$$\begin{aligned}
\text{h) } \log_3(x-2) + \log_3(x+6) = 2 &\implies \log_3((x-2)(x+6)) = \log_3(3^2) \\
&\implies (x-2)(x+6) = 3^2 \\
&\implies x^2 + 4x - 12 = 9 \\
&\implies x^2 + 4x - 21 = 0 \\
&\implies (x+7)(x-3) = 0 \\
&\implies x = -7 \text{ or } x = 3
\end{aligned}$$

We exclude $x = -7$, since we would obtain a negative value inside a logarithm, so that the solution is $x = 3$. \square

When the two sides of an equation are not exponentials with a common base, we can solve the equation by first applying a logarithm and then solving for x . Indeed, recall from Observation 7.9 in section 7.2 on inverse functions, that since $f(x) = \log_b(x)$ and $g(x) = b^x$ are inverse functions, we have $\log_b(b^x) = x$ and $b^{\log_b(x)} = x$ whenever the compositions of the left sides make sense. That is, the action of the logarithm cancels out the action of the exponential function, and vice versa. So we can think of applying a logarithm (an exponentiation) on both sides of an equation to cancel an exponentiation (a logarithm) much like squaring both sides of an equation to cancel a square root.

Example 14.6. Solve for x .

$$\begin{array}{lll}
\text{a) } 3^{x+5} = 8 & \text{b) } 13^{2x-4} = 6 & \text{c) } 5^{x-7} = 2^x \\
\text{d) } 5.1^x = 2.7^{2x+6} & \text{e) } 17^{x-2} = 3^{x+4} & \text{f) } 7^{2x+3} = 11^{3x-6}
\end{array}$$

Solution. We solve these equations by applying a logarithm (both \log or \ln will work for solving the equation), and then we use the identity $\log(a^x) =$

$x \cdot \log(a)$.

$$\begin{aligned}
 \text{a) } 3^{x+5} = 8 &\implies \ln 3^{x+5} = \ln 8 \implies (x+5) \cdot \ln 3 = \ln 8 \\
 &\implies x+5 = \frac{\ln 8}{\ln 3} \implies x = \frac{\ln 8}{\ln 3} - 5 \approx -3.11 \\
 \text{b) } 13^{2x-4} = 6 &\implies \ln 13^{2x-4} = \ln 6 \implies (2x-4) \cdot \ln 13 = \ln 6 \\
 &\implies 2x-4 = \frac{\ln 6}{\ln 13} \implies 2x = \frac{\ln 6}{\ln 13} + 4 \\
 &\implies x = \frac{\frac{\ln 6}{\ln 13} + 4}{2} = \frac{\ln 6}{2 \cdot \ln 13} + 2 \approx 2.35 \\
 \text{c) } 5^{x-7} = 2^x &\implies \ln 5^{x-7} = \ln 2^x \implies (x-7) \cdot \ln 5 = x \cdot \ln 2
 \end{aligned}$$

At this point, the calculation will proceed differently than the calculations in parts (a) and (b). Since x appears on both sides of $(x-7) \cdot \ln 5 = x \cdot \ln 2$, we need to separate terms involving x from terms without x . That is, we need to distribute $\ln 5$ on the left and separate the terms. We have

$$\begin{aligned}
 (x-7) \cdot \ln 5 = x \cdot \ln 2 &\implies x \cdot \ln 5 - 7 \cdot \ln 5 = x \cdot \ln 2 \\
 (\text{add } +7 \cdot \ln 5 - x \cdot \ln 2) &\implies x \cdot \ln 5 - x \cdot \ln 2 = 7 \cdot \ln 5 \\
 &\implies x \cdot (\ln 5 - \ln 2) = 7 \cdot \ln 5 \\
 &\implies x = \frac{7 \cdot \ln 5}{\ln 5 - \ln 2} \approx 12.30
 \end{aligned}$$

We need to apply the same solution strategy for the remaining parts (d)-(f) as we did in (c).

$$\begin{aligned}
 \text{d) } 5.1^x = 2.7^{2x+6} &\implies \ln 5.1^x = \ln 2.7^{2x+6} \\
 &\implies x \cdot \ln 5.1 = (2x+6) \cdot \ln 2.7 \\
 &\implies x \cdot \ln 5.1 = 2x \cdot \ln 2.7 + 6 \cdot \ln 2.7 \\
 &\implies x \cdot \ln 5.1 - 2x \cdot \ln 2.7 = 6 \cdot \ln 2.7 \\
 &\implies x \cdot (\ln 5.1 - 2 \cdot \ln 2.7) = 6 \cdot \ln 2.7 \\
 &\implies x = \frac{6 \cdot \ln 2.7}{\ln 5.1 - 2 \cdot \ln 2.7} \approx -16.68 \\
 \text{e) } 17^{x-2} = 3^{x+4} &\implies \ln 17^{x-2} = \ln 3^{x+4} \\
 &\implies (x-2) \cdot \ln 17 = (x+4) \cdot \ln 3
 \end{aligned}$$

$$\begin{aligned} \implies x \cdot \ln 17 - 2 \cdot \ln 17 &= x \cdot \ln 3 + 4 \cdot \ln 3 \\ \implies x \cdot \ln 17 - x \cdot \ln 3 &= 2 \cdot \ln 17 + 4 \cdot \ln 3 \\ \implies x \cdot (\ln 17 - \ln 3) &= 2 \cdot \ln 17 + 4 \cdot \ln 3 \\ \implies x &= \frac{2 \cdot \ln 17 + 4 \cdot \ln 3}{\ln 17 - \ln 3} \approx 5.80 \end{aligned}$$

$$\begin{aligned} \text{f) } 7^{2x+3} = 11^{3x-6} &\implies \ln 7^{2x+3} = \ln 11^{3x-6} \\ &\implies (2x+3) \cdot \ln 7 = (3x-6) \cdot \ln 11 \\ &\implies 2x \cdot \ln 7 + 3 \cdot \ln 7 = 3x \cdot \ln 11 - 6 \cdot \ln 11 \\ &\implies 2x \cdot \ln 7 - 3x \cdot \ln 11 = -3 \cdot \ln 7 - 6 \cdot \ln 11 \\ &\implies x \cdot (2 \cdot \ln 7 - 3 \cdot \ln 11) = -3 \cdot \ln 7 - 6 \cdot \ln 11 \\ &\implies x = \frac{-3 \cdot \ln 7 - 6 \cdot \ln 11}{2 \cdot \ln 7 - 3 \cdot \ln 11} \approx 6.13 \end{aligned}$$

□

Note that in the problems above we could have also changed the base as we did earlier in the section. For example, in part f) above, we could have begun by writing the right hand side as $11^{3x-6} = 7^{\log_7(11^{3x-6})}$. We chose to simply apply a log to both sides instead, because the notation is somewhat simpler.

14.3 Exercises

Exercise 14.1. Combine the terms and write your answer as one logarithm.

$$\begin{array}{ll} \text{a) } 3 \ln(x) + \ln(y) & \text{b) } \log(x) - \frac{2}{3} \log(y) \\ \text{c) } \frac{1}{3} \log(x) - \log(y) + 4 \log(z) & \text{d) } \log(xy^2z^3) - \log(x^4y^3z^2) \\ \text{e) } \frac{1}{4} \ln(x) - \frac{1}{2} \ln(y) + \frac{2}{3} \ln(z) & \text{f) } -\ln(x^2 - 1) + \ln(x - 1) \\ \text{g) } 5 \ln(x) + 2 \ln(x^4) - 3 \ln(x) & \text{h) } \log_5(a^2 + 10a + 9) - \log_5(a + 9) + 2 \end{array}$$

Exercise 14.2. Write the expressions in terms of elementary logarithms $u = \log_b(x)$, $v = \log_b(y)$, and $w = \log_b(z)$ (whichever are applicable). Assume that

$x, y, z > 0$.

$$\begin{array}{lll} \text{a) } \log(x^3 \cdot y) & \text{b) } \log(\sqrt[3]{x^2} \cdot \sqrt[4]{y^7}) & \text{c) } \log(\sqrt{x \cdot \sqrt[3]{y}}) \\ \text{d) } \ln\left(\frac{x^3}{y^4}\right) & \text{e) } \ln\left(\frac{x^2}{\sqrt{y \cdot z^2}}\right) & \text{f) } \log_3\left(\sqrt{\frac{x \cdot y^3}{\sqrt{z}}}\right) \\ \text{g) } \log_2\left(\frac{\sqrt[4]{x^3 \cdot z}}{y^3}\right) & \text{h) } \log\left(\frac{100 \sqrt[5]{z}}{y^2}\right) & \text{i) } \ln\left(\sqrt[3]{\frac{\sqrt{y \cdot z^4}}{e^2}}\right) \end{array}$$

Exercise 14.3. Solve for x without using a calculator.

$$\begin{array}{ll} \text{a) } 6^{x-2} = 36 & \text{b) } 2^{3x-8} = 16 \\ \text{c) } 10^{5-x} = 0.0001 & \text{d) } 5^{5x+7} = \frac{1}{125} \\ \text{e) } 2^x = 64^{x+1} & \text{f) } 4^{x+3} = 32^x \\ \text{g) } 13^{4+2x} = 1 & \text{h) } 3^{x+2} = 27^{x-3} \\ \text{i) } 25^{7x-4} = 5^{2-3x} & \text{j) } 9^{5+3x} = 27^{8-2x} \end{array}$$

Exercise 14.4. Solve for x without using a calculator.

$$\begin{array}{ll} \text{a) } \ln(2x+4) = \ln(5x-5) & \text{b) } \ln(x+6) = \ln(x-2) + \ln(3) \\ \text{c) } \log_2(x+5) = \log_2(x) + 5 & \text{d) } \log(x) + 1 = \log(5x+380) \\ \text{e) } \log(x+5) + \log(x) = \log(6) & \text{f) } \log_2(x) + \log_2(x-6) = 4 \\ \text{g) } \log_6(x) + \log_6(x-16) = 2 & \text{h) } \log_5(x-24) + \log_5(x) = 2 \\ \text{i) } \log_4(x) + \log_4(x+6) = 2 & \text{j) } \log_2(x+3) + \log_2(x+5) = 3 \end{array}$$

Exercise 14.5. Solve for x . First find the exact answer as an expression involving logarithms. Then approximate the answer to the nearest hundredth using the calculator.

$$\begin{array}{lll} \text{a) } 4^x = 57 & \text{b) } 9^{x-2} = 7 & \text{c) } 2^{x+1} = 31 \\ \text{d) } 3.8^{2x+7} = 63 & \text{e) } 5^{x+5} = 8^x & \text{f) } 3^{x+2} = 0.4^x \\ \text{g) } 1.02^{2x-9} = 4.35^x & \text{h) } 4^{x+1} = 5^{x+2} & \text{i) } 9^{3-x} = 4^{x-6} \\ \text{j) } 2.4^{7-2x} = 3.8^{3x+4} & \text{k) } 4^{9x-2} = 9^{2x-4} & \text{l) } 1.95^{-3x-4} = 1.2^{4-7x} \end{array}$$

Session 15

Applications of the exponential and the logarithm

15.1 Applications of exponential functions

Before giving specific applications, we note that the exponential function $y = c \cdot b^x$ is uniquely determined by providing any two of its function values.

Example 15.1. Let $f(x) = c \cdot b^x$. Determine the constant c and base b under the given conditions.

$$\begin{array}{ll} \text{a) } f(0) = 5, & f(1) = 20 \\ \text{c) } f(2) = 160, & f(7) = 5 \end{array} \quad \begin{array}{ll} \text{b) } f(0) = 3, & f(4) = 48 \\ \text{d) } f(-2) = 55, & f(1) = 7 \end{array}$$

Solution. a) Applying $f(0) = 5$ to $f(x) = c \cdot b^x$, we get

$$5 = f(0) = c \cdot b^0 = c \cdot 1 = c$$

Indeed, in general, we always have $f(0) = c$ for any exponential function. The base b is then determined by substituting the second equation $f(1) = 20$.

$$20 = f(1) = c \cdot b^1 = 5 \cdot b \xrightarrow{(\div 5)} b = 4$$

Therefore, $f(x) = 5 \cdot 4^x$. Note that in the last implication, we used that the base must be positive.

b) As before, we get $3 = f(0) = c \cdot b^0 = c$, and

$$48 = f(4) = c \cdot b^4 = 3 \cdot b^4 \xrightarrow{(\div 3)} 16 = b^4 \xrightarrow{\text{(exponentiate by } \frac{1}{4})} b = 16^{\frac{1}{4}} = 2$$

Therefore, $f(x) = 3 \cdot 2^x$.

c) When $f(0)$ is not given, it is easiest to solve for b first. We can see this as follows. Since $160 = f(2) = c \cdot b^2$ and $5 = f(7) = c \cdot b^7$, the quotient of these equations eliminates c .

$$\frac{160}{5} = \frac{c \cdot b^2}{c \cdot b^7} = \frac{1}{b^5} \quad \Longrightarrow \quad 32 = b^{-5}$$

$$\xRightarrow{\text{(exponentiate by } (-\frac{1}{5}))} \quad b = 32^{-\frac{1}{5}} = \frac{1}{32^{\frac{1}{5}}} = \frac{1}{2}$$

Then c is determined by any of the original equations.

$$160 = f(2) = c \cdot b^2 = c \cdot \left(\frac{1}{2}\right)^2 = c \cdot \frac{1}{4} \quad \Longrightarrow \quad c = 4 \cdot 160 = 640$$

Therefore, $f(x) = 640 \cdot \left(\frac{1}{2}\right)^x$.

d) This solution is similar to part (c).

$$\frac{55}{7} = \frac{f(-2)}{f(1)} = \frac{c \cdot b^{-2}}{c \cdot b^1} = \frac{1}{b^3} \quad \Longrightarrow \quad b^3 = \frac{7}{55}$$

$$\Longrightarrow \quad b = \left(\frac{7}{55}\right)^{\frac{1}{3}} \approx 0.503$$

$$55 = f(-2) = c \cdot b^{-2} = c \cdot \left(\left(\frac{7}{55}\right)^{\frac{1}{3}}\right)^{-2} = c \cdot \left(\frac{7}{55}\right)^{-\frac{2}{3}}$$

$$\Longrightarrow \quad c = \frac{55}{\left(\frac{7}{55}\right)^{-\frac{2}{3}}} = 55 \cdot \left(\frac{7^{\frac{2}{3}}}{55^{\frac{2}{3}}}\right) = 55^{\frac{1}{3}} \cdot 7^{\frac{2}{3}} = \sqrt[3]{55 \cdot 7^2} = \sqrt[3]{2695} \approx 13.916$$

therefore, $f(x) = \sqrt[3]{2695} \cdot \left(\sqrt[3]{\frac{7}{55}}\right)^x$. □

Many situations are modeled by exponential functions.

Example 15.2. The mass of a bacteria sample is $2 \cdot 1.02^t$ grams after t hours.

- What is the mass of the bacteria sample after 4 hours?
- When will the mass reach 10 grams?

Solution. a) The formula for the mass y in grams after t hours is $y(t) = 2 \cdot 1.02^t$. Therefore, after 4 hours, the mass in grams is

$$y(4) = 2 \cdot 1.02^4 \approx 2.16.$$

b) We are seeking the number of hours t for which $y = 10$ grams. Therefore, we have to solve:

$$10 = 2 \cdot 1.02^t \quad \xrightarrow{(\div 2)} \quad 5 = 1.02^t$$

We need to solve for the variable in the exponent. In general, to solve for a variable in the exponent requires an application of a logarithm on both sides of the equation.

$$5 = 1.02^t \quad \xrightarrow{(\text{apply log})} \quad \log(5) = \log(1.02^t)$$

Recall one of the main properties that we need to solve for t :

$$\log(x^t) = t \cdot \log(x) \tag{15.1}$$

Using this fact, we can now solve for t :

$$\begin{aligned} \log(5) = \log(1.02^t) & \implies \log(5) = t \cdot \log(1.02) \\ & \xrightarrow{(\text{divide by } \log(1.02))} \frac{\log(5)}{\log(1.02)} = t \end{aligned}$$

Using the $\boxed{\log}$ key on the calculator, we may approximate this as

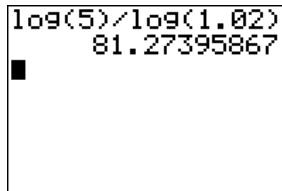

```

log(5)/log(1.02)
81.27395867

```

$$t = \frac{\log(5)}{\log(1.02)} \approx 81.3$$

After approximately 81.3 hours, the mass will be 10 grams.

Note that the formula $2 \cdot 1.02^t$ comes from the following calculations. Suppose that after each hour there is an increase of 2 percent of the mass and that the initial mass of the bacteria is 2 grams. Then after the first hour we see that the mass in grams is

$$2 + 2 \cdot (.02) = 2(1 + .02) = 2(1.02)$$

and that after the second hour the mass is

$$2(1.02) + 2(1.02)(.02) = 2(1.02)(1 + .02) = 2(1.02)^2$$

and that after three hours the mass is

$$2(1.02)^2 + 2(1.02)^2(.02) = 2(1.02)^2(1 + .02) = 2(1.02)^3.$$

Continuing in this manner we can see that, at least for whole numbers of hours t , the weight is given by

$$2 \cdot 1.02^t.$$

The same sort of idea can be used in all of the following applications. \square

Example 15.3. The population size of a country was 12.7 million in the year 2000, and 14.3 million in the year 2010.

- Assuming an exponential growth for the population size, find the formula for the population depending on the year t .
- What will the population size be in the year 2015, assuming the formula holds until then?
- When will the population reach 18 million?

Solution. a) The growth is assumed to be exponential, so that $y(t) = c \cdot b^t$ describes the population size depending on the year t , where we set $t = 0$ corresponding to the year 2000. Then the example describes $y(0) = c$ as $c = 12.7$, which we assume in units of millions. To find the base b , we substitute the data of $t = 10$ and $y(t) = 14.3$ into $y(t) = c \cdot b^t$.

$$\begin{aligned} 14.3 = 12.7 \cdot b^{10} &\implies \frac{14.3}{12.7} = b^{10} &\implies \left(\frac{14.3}{12.7}\right)^{\frac{1}{10}} = (b^{10})^{\frac{1}{10}} = b \\ &\implies b = \left(\frac{14.3}{12.7}\right)^{\frac{1}{10}} \approx 1.012 \end{aligned}$$

The formula for the population size is $y(t) \approx 12.7 \cdot 1.012^t$.

- b) We calculate the population size in the year 2015 by setting $t = 15$:

$$y(15) = 12.7 \cdot 1.012^{15} \approx 15.2$$

- c) We seek t so that $y(t) = 18$. We solve for t using the logarithm.

$$18 = 12.7 \cdot 1.012^t \implies \frac{18}{12.7} = 1.012^t \implies \log\left(\frac{18}{12.7}\right) = \log(1.012^t)$$

$$\begin{aligned} \implies \log\left(\frac{18}{12.7}\right) &= t \cdot \log(1.012) \\ \implies t &= \frac{\log\left(\frac{18}{12.7}\right)}{\log(1.012)} \approx 29.2 \end{aligned}$$

The population will reach 18 million in the year 2029. □

In many instances the exponential function $f(x) = c \cdot b^x$ is given via a rate of growth r .

Definition 15.4. An exponential function with a **rate of growth** r is a function $f(x) = c \cdot b^x$ with base

$$\boxed{b = 1 + r}.$$

For an example of why this is a reasonable definition see the note following Example 15.2.

Note 15.5. We want to point out that some authors use a different convention than the one given in definition 15.4. Indeed, sometimes a function with rate of growth r is defined as an exponential function with base $b = e^r$, whereas for us it has base $b = 1 + r$. Since e^r can be expanded as $e^r = 1 + r + \frac{r^2}{2} + \dots$, we see that the two versions only differ by an error of order 2.

Example 15.6. The number of PCs that are sold in the U.S. in the year 2011 is approximately 350 million with a rate of growth of 3.6% per year. Assuming the rate stays constant over the next years, how many PCs will be sold in the year 2015?

Solution. Since the rate of growth is $r = 3.6\% = 0.036$, we obtain a base of $b = 1 + r = 1.036$, giving the number of PCs to be modeled by $c(1.036)^t$. If we set $t = 0$ for the year 2011, we find that $c = 350$, so the number of sales is given by $y(t) = 350 \cdot 1.036^t$. Since the year 2015 corresponds to $t = 4$, we can calculate the number of sales in the year 2015 as

$$y(4) = 350 \cdot 1.036^4 \approx 403.$$

Approximately 403 million PCs will be sold in the year 2015. □

Example 15.7. The size of an ant colony is decreasing at a rate of 1% per month. How long will it take until the colony has reached 80% of its original size?

Solution. Since $r = -1\% = -0.01$, we obtain the base $b = 1 + r = 1 - 0.01 = 0.99$. We have a colony size of $y(t) = c \cdot 0.99^t$ after t months, where c is the original size. We need to find t so that the size is at 80% of its original size c , that is, $y(t) = 80\% \cdot c = 0.8 \cdot c$.

$$\begin{aligned} 0.8 \cdot c &= c \cdot 0.99^t && \xrightarrow{(\div c)} && 0.8 = 0.99^t && \implies \log(0.8) = \log(0.99^t) \\ &&& && \implies \log(0.8) = t \cdot \log(0.99) \\ &&& && \implies t = \frac{\log(0.8)}{\log(0.99)} \approx 22.2 \end{aligned}$$

After approximately 22.2 months, the ant colony has decreased to 80% of its original size. \square

Example 15.8. a) The population size of a country is increasing at a rate of 4% per year. How long does it take until the country has doubled its population size?

b) The number of new flu cases is decreasing at a rate of 5% per week. After how much time will the number of new flu cases reach a quarter of its current level?

Solution. a) The rate of change is $r = 4\% = 0.04$, so that population size is an exponential function with base $b = 1 + 0.04 = 1.04$. Therefore, $f(x) = c \cdot 1.04^x$ denotes the population size, with c being the initial population in the year corresponding to $x = 0$. In order for the population size to double, $f(x)$ has to reach twice its initial size, that is:

$$\begin{aligned} f(x) = 2c &\implies c \cdot 1.04^x = 2c && \xrightarrow{(\div c)} && 1.04^x = 2 \\ &\implies \log(1.04^x) = \log(2) && \implies && x \log(1.04) = \log(2) \\ &\implies x = \frac{\log(2)}{\log(1.04)} \approx 17.7 \end{aligned}$$

It will take about 17.7 years until the population size has doubled.

b) Since the number of new flu cases is decreasing, the rate of growth is negative, $r = -5\% = -0.05$ per week, so that we have an exponential function with base $b = 1 + r = 1 + (-0.05) = 0.95$. To reach a quarter of its initial number of flu cases, we set $f(x) = c \cdot 0.95^x$ equal to $\frac{1}{4}c$.

$$c \cdot 0.95^x = \frac{1}{4}c \quad \xrightarrow{(\div c)} \quad 0.95^x = \frac{1}{4} \quad \implies \quad x \log(0.95) = \log\left(\frac{1}{4}\right)$$

$$\implies x = \frac{\log(\frac{1}{4})}{\log(0.95)} \approx 27.0$$

It will therefore take about 27 weeks until the number of new flu cases has decreased to a quarter of its current level. \square

15.2 Exercises

Exercise 15.1. Assuming that $f(x) = c \cdot b^x$ is an exponential function, find the constants c and b from the given conditions.

- | | | | |
|---------------------|-----------------|-----------------|-------------|
| a) $f(0) = 4,$ | $f(1) = 12$ | b) $f(0) = 5,$ | $f(3) = 40$ |
| c) $f(0) = 3, 200,$ | $f(6) = 0.0032$ | d) $f(3) = 12,$ | $f(5) = 48$ |
| e) $f(-1) = 4,$ | $f(2) = 500$ | f) $f(2) = 3,$ | $f(4) = 15$ |

Exercise 15.2. The number of downloads of a certain software application was 8.4 million in the year 2005 and 13.6 million in the year 2010.

- Assuming an exponential growth for the number of downloads, find the formula for the downloads depending on the year t .
- Assuming the number of downloads will follow the formula from part (a), what will the number of downloads be in the year 2015?
- In which year will the number of downloaded applications reach the 20 million barrier?

Exercise 15.3. The population size of a city was 79,000 in the year 1990 and 136,000 in the year 2005. Assume that the population size follows an exponential function.

- Find the formula for the population size.
- What is the population size in the year 2010?
- What is the population size in the year 2015?
- When will the city reach its expected maximum capacity of 1,000,000 residents?

Exercise 15.4. The population of a city decreases at a rate of 2.3% per year. After how many years will the population be at 90% of its current size? Round your answer to the nearest tenth.

Exercise 15.5. A big company plans to expand its franchise and, with this, its number of employees. For tax reasons it is most beneficial to expand the number of employees at a rate of 5% per year. If the company currently has 4,730 employees, how many years will it take until the company has 6,000 employees? Round your answer to the nearest hundredth.

Exercise 15.6. An ant colony has a population size of 4,000 ants and is increasing at a rate of 3% per week. How long will it take until the ant population has doubled? Round your answer to the nearest tenth.

Exercise 15.7. The size of a beehive is decreasing at a rate of 15% per month. How long will it take for the beehive to be at half of its current size? Round your answer to the nearest hundredth.

Exercise 15.8. If the population size of the world is increasing at a rate of 0.5% per year, how long does it take until the world population doubles in size? Round your answer to the nearest tenth.

Session 16

More applications: Half-life and compound interest

We have already encountered applications of the logarithm in solving equations in section 15.1. In this chapter we solve more equations related to applications by using the logarithm.

16.1 Half-life

Recall from definition 15.4 on page 212 that a function with rate of growth r is an exponential function $f(x) = c \cdot b^x$ with base $b = 1 + r$. There is also another important way of determining the base of an exponential function, which is given by the notion of half-life. We start with a motivating example.

Example 16.1. Consider the function $f(x) = 200 \cdot \left(\frac{1}{2}\right)^{\frac{x}{7}}$. We calculate the function values $f(x)$, for $x = 0, 7, 14, 21$, and 28 .

$$f(0) = 200 \cdot \left(\frac{1}{2}\right)^{\frac{0}{7}} = 200 \cdot 1 = 200$$

$$f(7) = 200 \cdot \left(\frac{1}{2}\right)^{\frac{7}{7}} = 200 \cdot \frac{1}{2} = 100$$

$$f(14) = 200 \cdot \left(\frac{1}{2}\right)^{\frac{14}{7}} = 200 \cdot \frac{1}{4} = 50$$

$$f(21) = 200 \cdot \left(\frac{1}{2}\right)^{\frac{21}{7}} = 200 \cdot \frac{1}{8} = 25$$

$$f(28) = 200 \cdot \left(\frac{1}{2}\right)^{\frac{28}{7}} = 200 \cdot \frac{1}{16} = 12.5$$

From this calculation, we can see how the function values of f behave: starting from $f(0) = 200$, the function takes half of its value whenever x is increased by 7. For this reason, we say that f has a *half-life* of 7. (The general definition will be given below.) The graph of the function is displayed below.

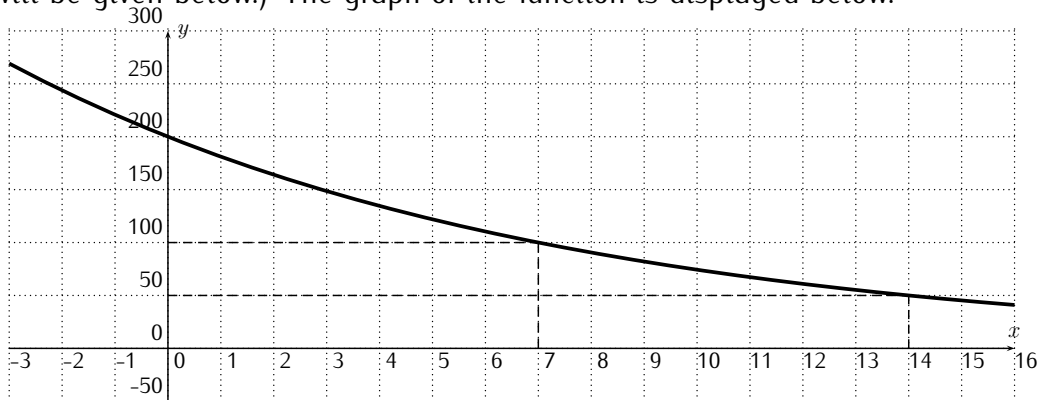

We collect the ideas that are displayed in the above example in the definition and observation below.

Definition 16.2. Let f be an exponential function $f(x) = c \cdot b^x$ with a domain of all real numbers, $D = \mathbb{R}$. Then we say that f has a **half-life** of h , if the base is given by

$$b = \left(\frac{1}{2}\right)^{\frac{1}{h}} \quad (16.1)$$

Note that we can also write h in terms of b . Converting (16.1) into a logarithmic equation gives $\frac{1}{h} = \log_{\frac{1}{2}}(b) = \frac{\log b}{\log \frac{1}{2}}$, so that $h = \frac{\log \frac{1}{2}}{\log b} = \log_b \left(\frac{1}{2}\right)$.

Observation 16.3. Let f be the exponential function given for some real constants $c > 0$ and half-life $h > 0$, that is

$$f(x) = c \cdot \left(\left(\frac{1}{2}\right)^{\frac{1}{h}}\right)^x = c \cdot \left(\frac{1}{2}\right)^{\frac{x}{h}}.$$

Then we can calculate $f(x+h)$ as follows:

$$f(x+h) = c \cdot \left(\frac{1}{2}\right)^{\frac{x+h}{h}} = c \cdot \left(\frac{1}{2}\right)^{\frac{x}{h} + \frac{h}{h}} = c \cdot \left(\frac{1}{2}\right)^{\frac{x}{h} + 1}$$

$$= c \cdot \left(\frac{1}{2}\right)^{\frac{x}{h}} \cdot \left(\frac{1}{2}\right)^1 = \frac{1}{2} \cdot f(x)$$

To summarize, f has the following property:

$$\boxed{f(x+h) = \frac{1}{2}f(x)} \quad \text{for all } x \in \mathbb{R}. \quad (16.2)$$

The above equation shows that, whenever we add an amount of h to an input x , the effect on f is that the function value decreases by half its previous value. This is also displayed in the graph below.

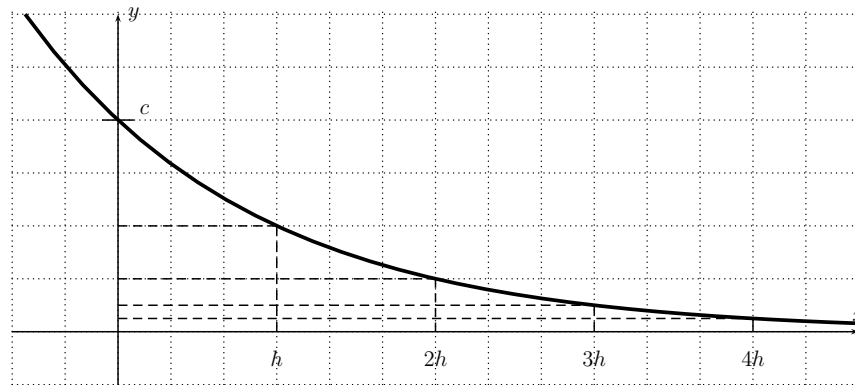

We will sometimes use a different letter for the input variable. In particular, the function $f(x) = c \cdot \left(\frac{1}{2}\right)^{\frac{x}{h}}$ is the same as the function $f(t) = c \cdot \left(\frac{1}{2}\right)^{\frac{t}{h}}$.

Many radioactive isotopes decay with well-known half-lives.

Example 16.4.

- Chromium-51 has a half-life of 27.7 days¹. How much of 3 grams of chromium-51 will remain after 90 days?
- An isotope decays within 20 hours from 5 grams to 2.17 grams. Find the half-life of the isotope.

Solution. a) We use the above formula $y = c \cdot \left(\frac{1}{2}\right)^{\frac{t}{h}}$, where $c = 3$ grams is the initial amount of chromium-51, $h = 27.7$ days is the half-life of chromium-51,

¹Half-lives are taken from: http://en.wikipedia.org/wiki/List_of_isotopes_by_half-life

and $t = 90$ days is time that the isotope decayed. Substituting these numbers into the formula for y , we obtain:

$$y = 3 \cdot \left(\frac{1}{2}\right)^{\frac{90}{27.7}} \approx 0.316$$

Therefore, after 90 days, 0.316 grams of the chromium-51 is remaining.

b) We have an initial amount of $c = 5$ grams and a remaining amount of $y = 2.17$ grams after $t = 20$ hours. The half-life can be obtained as follows.

$$\begin{aligned} 2.17 &= 5 \cdot \left(\frac{1}{2}\right)^{\frac{20}{h}} && \xrightarrow{(\div 5)} && 0.434 = \left(\frac{1}{2}\right)^{\frac{20}{h}} \\ &&& \xrightarrow{(\text{apply } \ln)} && \ln(0.434) = \ln\left(0.5^{\frac{20}{h}}\right) \\ &&& \implies && \ln(0.434) = \frac{20}{h} \cdot \ln(0.5) \\ &&& \xrightarrow{(\times \frac{h}{\ln(0.434)})} && h = \frac{20 \cdot \ln(0.5)}{\ln(0.434)} \\ &&& \implies && t \approx 16.6 \end{aligned}$$

Therefore, the half-life of the isotope is approximately 16.6 hours. \square

Note 16.5. An important isotope is the radioisotope carbon-14. It decays with a half-life of 5730 years with an accuracy of ± 40 years. For definiteness we will take 5730 years as the half-life of carbon-14.

The half-life of carbon-14 is 5730 years.

One can use the knowledge of the half-life of carbon-14 in dating organic materials via the so called **carbon dating method**. Carbon-14 is produced by a plant during the process of photosynthesis at a fixed level until the plant dies. Therefore by measuring the remaining amount of carbon-14 in a dead plant one can determine the date when the plant died. Furthermore, since humans and animals consume plants, the same argument can be applied to determine their (approximate) dates of death.

Example 16.6.

a) A dead tree trunk has 86% of its original carbon-14. (Approximately) how many years ago did the tree die?

- b) A dead animal at an archeological site has lost 41.3% of its carbon-14. When did the animal die?

Solution. a) Using the function $y = c \cdot \left(\frac{1}{2}\right)^{\frac{t}{h}}$, where c is the amount of carbon-14 that was produced by the tree until it died, y is the remaining amount to date, t is the time that has passed since the tree has died, and h is the half-life of carbon-14. Since 86% of the carbon-14 is left, we have $y = 86\% \cdot c$. Substituting the half-life $h = 5730$ of carbon-14, we can solve for t .

$$\begin{aligned}
 0.86 \cdot c &= c \cdot \left(\frac{1}{2}\right)^{\frac{t}{5730}} && \xrightarrow{(\div c)} && 0.86 &= \left(\frac{1}{2}\right)^{\frac{t}{5730}} \\
 &&& \xrightarrow{(\text{apply } \ln)} && \ln(0.86) &= \ln\left(0.5^{\frac{t}{5730}}\right) \\
 &&& \implies && \ln(0.86) &= \frac{t}{5730} \cdot \ln(0.5) \\
 &&& \xrightarrow{\left(\times \frac{5730}{\ln(0.5)}\right)} && \frac{5730}{\ln(0.5)} \cdot \ln(0.86) &= t \\
 &&& \implies && t &\approx 1247
 \end{aligned}$$

Therefore, the tree died approximately 1247 years ago.

b) Since 41.3% of the carbon-14 is gone, $100\% - 41.3\% = 58.7\%$ is remaining. Using $y = c \cdot \left(\frac{1}{2}\right)^{\frac{t}{h}}$ with $y = 58.7\% \cdot c$ and $h = 5730$, we obtain

$$\begin{aligned}
 0.587 \cdot c &= c \cdot \left(\frac{1}{2}\right)^{\frac{t}{5730}} && \xrightarrow{(\div c)} && 0.587 &= \left(\frac{1}{2}\right)^{\frac{t}{5730}} \\
 &&& \xrightarrow{(\text{apply } \ln)} && \ln(0.587) &= \ln\left(0.5^{\frac{t}{5730}}\right) \\
 &&& \implies && \ln(0.587) &= \frac{t}{5730} \cdot \ln(0.5) \\
 &&& \xrightarrow{\left(\times \frac{5730}{\ln(0.5)}\right)} && \frac{5730}{\ln(0.5)} \cdot \ln(0.587) &= t \\
 &&& \implies && t &\approx 4404
 \end{aligned}$$

The animal died 4404 years ago. □

16.2 Compound interest

There is another interesting and important application of the exponential function given by calculating the interest on an investment. We start with the

following motivating example.

Example 16.7.

- We invest an initial amount of $P = \$500$ for 1 year at a rate of $r = 6\%$. The initial amount P is also called the **principal**.

After 1 year, we receive the principal P together with the interest $r \cdot P$ generated from the principal. The final amount A after 1 year is therefore

$$A = \$500 + 6\% \cdot \$500 = \$500 \cdot (1 + 0.06) = \$530.$$

- We change the setup of the previous example by taking a quarterly compounding. This means, that instead of receiving interest on the principal once at the end of the year, we receive the interest 4 times within the year (after each quarter). However, we now receive only $\frac{1}{4}$ of the interest rate of 6%. We break down the amount received after each quarter.

$$\text{after first quarter: } 500 \cdot \left(1 + \frac{0.06}{4}\right) = 500 \cdot 1.015$$

$$\text{after second quarter: } (500 \cdot 1.015) \cdot \left(1 + \frac{0.06}{4}\right) = 500 \cdot 1.015^2$$

$$\text{after third quarter: } (500 \cdot 1.015^2) \cdot \left(1 + \frac{0.06}{4}\right) = 500 \cdot 1.015^3$$

$$\text{after fourth quarter: } A = (500 \cdot 1.015^3) \cdot \left(1 + \frac{0.06}{4}\right) = 500 \cdot 1.015^4$$

$$\implies A \approx 530.68$$

Note that in the second quarter, we receive interest on the amount we had after the first quarter, and so on. So, in fact, we keep receiving interest on the interest of the interest, etc. For this reason, the final amount received after 1 year $A = \$530.68$ is slightly higher when compounded quarterly than when compounded annually (where $A = \$530.00$).

- We make an even further variation from the above. Instead of investing money for 1 year, we invest the principal for 10 years at a quarterly compounding. We then receive interest every quarter for a total of $4 \cdot 10 = 40$ quarters.

$$\text{after first quarter: } 500 \cdot \left(1 + \frac{0.06}{4}\right) = 500 \cdot 1.015$$

$$\begin{aligned}
 \text{after second quarter:} & \quad (500 \cdot 1.015) \cdot \left(1 + \frac{0.06}{4}\right) = 500 \cdot 1.015^2 \\
 & \quad \vdots \\
 \text{after fortieth quarter:} & \quad A = (500 \cdot 1.015^{39}) \cdot \left(1 + \frac{0.06}{4}\right) = 500 \cdot 1.015^{40} \\
 & \quad \implies A \approx 907.01
 \end{aligned}$$

We state our observations from the previous example in the following general observation.

Observation 16.8. A principal (=initial amount) P is invested for t years at a rate r and compounded n times per year. The final amount A is given by

$$\boxed{A = P \cdot \left(1 + \frac{r}{n}\right)^{n \cdot t}} \quad \text{where} \quad \begin{cases} P = \text{principal (=initial) amount} \\ A = \text{final amount} \\ r = \text{annual interest rate} \\ n = \text{number of compoundings per year} \\ t = \text{number of years} \end{cases}$$

We can consider performing the compounding in smaller and smaller increments. Instead of quarterly compounding, we may take monthly compounding, or daily, hourly, secondly compounding or compounding in even smaller time intervals. Note, that in this case the number of compoundings n in the above formula tends to infinity. In the limit when the time intervals go to zero, we obtain what is called *continuous compounding*.

Observation 16.9. A principal amount P is invested for t years at a rate r and with **continuous compounding**. The final amount A is given by

$$\boxed{A = P \cdot e^{r \cdot t}} \quad \text{where} \quad \begin{cases} P = \text{principal amount} \\ A = \text{final amount} \\ r = \text{annual interest rate} \\ t = \text{number of years} \end{cases}$$

Note 16.10. The reason the exponential function appears in the above formula is that the exponential is the limit of the previous formula in observation 16.8, when n approaches infinity; compare this with equation (13.1) on page 187.

$$e^r = \lim_{n \rightarrow \infty} \left(1 + \frac{r}{n}\right)^n$$

A more detailed discussion of limits (including its definition) will be provided in a calculus course.

Example 16.11. Determine the final amount received on an investment under the given conditions.

- a) \$700, compounded monthly, at 4%, for 3 years
- b) \$2500, compounded semi-annually, at 5.5%, for 6 years
- c) \$1200, compounded continuously, at 3%, for 2 years

Solution. We can immediately use the formula by substituting the given values. For part (a), we have $P = 700$, $n = 12$, $r = 4\% = 0.04$, and $t = 3$. Therefore, we calculate

$$A = 700 \cdot \left(1 + \frac{0.04}{12}\right)^{12 \cdot 3} = 700 \cdot \left(1 + \frac{0.04}{12}\right)^{36} \approx 789.09$$

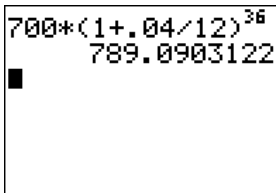

```

700*(1+.04/12)^36
789.0903122
  
```

b) We have $P = 2500$, $n = 2$, $r = 5.5\% = 0.055$, and $t = 6$.

$$A = 2500 \cdot \left(1 + \frac{0.055}{2}\right)^{2 \cdot 6} \approx 3461.96$$

c) We have $P = 1200$, $r = 3\% = 0.03$, $t = 2$, and we use the formula for continuous compounding.

$$A = 1200 \cdot e^{0.03 \cdot 2} = 1200 \cdot e^{0.06} \approx 1274.20$$

(Note that the Euler number is entered in the TI-84 via the keys 2nd and ln .)

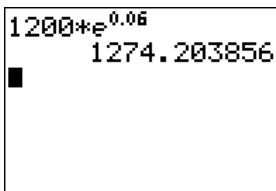

```

1200*e^0.06
1274.203856
  
```

□

Instead of asking to find the final amount, we may also ask about any of the other variables in the above formulas for investments.

Example 16.12.

- Find the amount P that needs to be invested at 4.275% compounded annually for 5 years to give a final amount of \$3000. (This amount P is also called the **present value** of the future amount of \$3000 in 5 years.)
- At what rate do we have to invest \$800 for 6 years compounded quarterly to obtain a final amount of \$1200?
- For how long do we have to invest \$1000 at a rate of 2.5% compounded continuously to obtain a final amount of \$1100?
- For how long do we have to invest at a rate of 3.2% compounded monthly until the investment doubles its value?

Solution. a) We have the following data: $r = 4.275\% = 0.04275$, $n = 1$, $t = 5$, and $A = 3000$. We want to find the present value P . Substituting the given numbers into the appropriate formula, we can solve this for P .

$$3000 = P \cdot \left(1 + \frac{0.04275}{1}\right)^{1 \cdot 5} \implies 3000 = P \cdot (1.04275)^5$$

$$\xrightarrow{\text{(divide by } 1.04275^5\text{)}} P = \frac{3000}{1.04275^5} \approx 2433.44$$

Therefore, if we invest \$2433.44 today under the given conditions, then this will be worth \$3000 in 5 years.

b) Substituting the given numbers ($P = 800$, $t = 6$, $n = 4$, $A = 1200$) into the formula gives:

$$1200 = 800 \cdot \left(1 + \frac{r}{4}\right)^{4 \cdot 6} \xrightarrow{\text{(divide by 800)}} \frac{1200}{800} = \left(1 + \frac{r}{4}\right)^{24}$$

$$\implies \left(1 + \frac{r}{4}\right)^{24} = \frac{3}{2}$$

Next, we have to get the exponent 24 to the right side. This is done by taking a power of $\frac{1}{24}$, or in other words, by taking the 24th root, $\sqrt[24]{\frac{3}{2}} = \left(\frac{3}{2}\right)^{\frac{1}{24}}$.

$$\left(\left(1 + \frac{r}{4}\right)^{24}\right)^{\frac{1}{24}} = \left(\frac{3}{2}\right)^{\frac{1}{24}} \implies \left(1 + \frac{r}{4}\right)^{24 \cdot \frac{1}{24}} = \left(\frac{3}{2}\right)^{\frac{1}{24}}$$

$$\Rightarrow 1 + \frac{r}{4} = \left(\frac{3}{2}\right)^{\frac{1}{24}} \Rightarrow \frac{r}{4} = \left(\frac{3}{2}\right)^{\frac{1}{24}} - 1 \Rightarrow r = 4 \cdot \left(\left(\frac{3}{2}\right)^{\frac{1}{24}} - 1\right)$$

We plug this into the calculator. Note that the n th root is given by pressing $\boxed{\text{math}}$ and $\boxed{5}$.

The calculator display shows the following steps and results:

- $(3/2)^{1/24}$ results in 1.017037897
- ${}^{24}\sqrt{3/2}$ (highlighted) results in 1.017037897
- $4 * ({}^{24}\sqrt{3/2} - 1)$ results in $.0681515864$

More precisely, the 24th root of $3/2$ (highlighted above) can be entered by pressing the following keys:

$$\boxed{2} \boxed{4} \boxed{\text{math}} \boxed{5} \boxed{3} \boxed{\div} \boxed{2} \boxed{\text{enter}}$$

Therefore our answer is $r \approx 0.06815 = 6.815\%$.

c) Again we substitute the given values, $P = 1000$, $r = 2.5\% = 0.025$, $A = 1100$, but now we use the formula for continuous compounding.

$$1100 = 1000 \cdot e^{0.025 \cdot t} \Rightarrow \frac{1100}{1000} = e^{0.025 \cdot t} \Rightarrow e^{0.025 \cdot t} = 1.1$$

To solve for the variable t in the exponent, we need to apply the logarithm. Here, it is most convenient to apply the natural logarithm, because $\ln(x)$ is inverse to e^x (which appears in the equation) and this logarithm is directly implemented on the calculator via the $\boxed{\ln}$ key. By applying \ln to both sides, since $\ln(x)$ is inverse to e^x , we see that $.025t = \ln(1.1)$.

Alternatively,

$$\ln(e^{0.025 \cdot t}) = \ln(1.1) \Rightarrow 0.025 \cdot t \cdot \ln(e) = \ln(1.1)$$

Here we have used that $\log_b(x^n) = n \cdot \log_b(x)$ for any number n as we have seen in proposition 14.1. Observing that $\ln(e) = 1$, which is the special case of the second equation in (13.3) on page 192 for the base $b = e$, the above becomes

$$0.025 \cdot t = \ln(1.1) \Rightarrow t = \frac{\ln(1.1)}{0.025} \approx 3.81$$

Therefore, we have to wait 4 years until the investment is worth (more than) \$1100.

d) We are given that $r = 3.2\% = 0.032$ and $n = 12$, but no initial amount P is provided. We are seeking to find the time t when the investment doubles. This means that the final amount A is twice the initial amount P , or as a formula: $A = 2 \cdot P$. Substituting this into the investment formula and solving gives the wanted answer.

$$\begin{aligned}
 2P &= P \cdot \left(1 + \frac{0.032}{12}\right)^{12 \cdot t} && \xrightarrow{\text{(divide by } P)} && 2 = \left(1 + \frac{0.032}{12}\right)^{12 \cdot t} \\
 \xrightarrow{\text{(apply } \ln)} & \ln(2) = \ln\left(\left(1 + \frac{0.032}{12}\right)^{12 \cdot t}\right) && \implies && \ln(2) = 12 \cdot t \cdot \ln\left(1 + \frac{0.032}{12}\right) \\
 & \xrightarrow{\text{(divide by } 12 \cdot \ln(1 + \frac{0.032}{12}))} && && t = \frac{\ln(2)}{12 \cdot \ln\left(1 + \frac{0.032}{12}\right)} \approx 21.69
 \end{aligned}$$

So, after approximately 21.69 years, the investment will have doubled in value.

□

16.3 Exercises

Exercise 16.1. An unstable element decays at a rate of 5.9% per minute. If 40mg of this element has been produced, then how long will it take until 2mg of the element are left? Round your answer to the nearest thousandth.

Exercise 16.2. A substance decays radioactively with a half-life of 232.5 days. How much of 6.8 grams of this substance is left after 1 year?

Exercise 16.3. Fermium-252 decays in 10 minutes to 76.1% of its original mass. Find the half-life of fermium-252.

Exercise 16.4. How long do you have to wait until 15mg of beryllium-7 have decayed to 4mg, if the half-life of beryllium-7 is 53.12 days?

Exercise 16.5. If Pharaoh Ramses II died in the year 1213 BC, then what percent of the carbon-14 was left in the mummy of Ramses II in the year 2000?

Exercise 16.6. In order to determine the age of a piece of wood, the amount of carbon-14 was measured. It was determined that the wood had lost 33.1% of its carbon-14. How old is this piece of wood?

Exercise 16.7. Archaeologists uncovered a bone at an ancient resting ground. It was determined that 62% of the carbon-14 was left in the bone. How old is the bone?

Exercise 16.8. An investment of \$5,000 was locked in for 30 years. According to the agreed conditions, the investment will be worth $\$5,000 \cdot 1.08^t$ after t years.

- How much is the investment worth after 5 years?
- After how many years will the investment be worth \$20,000?

Exercise 16.9. Determine the final amount in a savings account under the given conditions.

- \$700, compounded quarterly, at 3%, for 7 years
- \$1400, compounded annually, at 2.25%, for 5 years
- \$1400, compounded continuously, at 2.25%, for 5 years
- \$500, compounded monthly, at 3.99%, for 2 years
- \$5000, compounded continuously, at 7.4%, for 3 years
- \$1600, compounded daily, at 3.333%, for 1 year
- \$750, compounded semi-annually, at 4.9%, for 4 years

Exercise 16.10.

- Find the amount P that needs to be invested at a rate of 5% compounded quarterly for 6 years to give a final amount of \$2000.
- Find the present value P of a future amount of $A = \$3500$ invested at 6% compounded annually for 3 years.
- Find the present value P of a future amount of \$1000 invested at a rate of 4.9% compounded continuously for 7 years.
- At what rate do we have to invest \$1900 for 4 years compounded monthly to obtain a final amount of \$2250?
- At what rate do we have to invest \$1300 for 10 years compounded continuously to obtain a final amount of \$2000?
- For how long do we have to invest \$3400 at a rate of 5.125% compounded annually to obtain a final amount of \$3700?
- For how long do we have to invest \$1000 at a rate of 2.5% compounded continuously to obtain a final amount of \$1100?

- h) How long do you have to invest a principal at a rate of 6.75% compounded daily until the investment doubles its value?
- i) An certain amount of money has tripled its value while being in a savings account that has an interest rate of 8% compounded continuously. For how long was the money in the savings account?

Review of exponential and logarithmic functions

Exercise III.1. The population of a country grows exponentially at a rate of 1% per year. If the population was 35.7 million in the year 2010, then what is the population size of this country in the year 2015?

Exercise III.2. A radioactive substance decays exponentially at a rate of 7% per hour. How long do you have to wait until the substance has decayed to $\frac{1}{4}$ of its original size?

Exercise III.3. Combine to an expression with only one logarithm.

$$\text{a) } \frac{2}{3} \ln(x) + 4 \ln(y), \quad \text{b) } \frac{1}{2} \log_2(x) - \frac{3}{4} \log_2(y) + 3 \log_2(z)$$

Exercise III.4. Assuming that $x, y > 0$, write the following expressions in terms of $u = \log(x)$ and $v = \log(y)$:

$$\text{a) } \log\left(\frac{\sqrt[3]{x^4}}{y^2}\right), \quad \text{b) } \log\left(x\sqrt{y^5}\right), \quad \text{c) } \log\left(\sqrt[5]{xy^4}\right)$$

Exercise III.5. Solve without using the calculator: $\log_3(x) + \log_3(x-8) = 2$

Exercise III.6.

- a) Find the exact solution of the equation: $6^{x+2} = 7^x$
b) Use the calculator to approximate your solution from part (a).

Exercise III.7. 45mg of fluorine-18 decay in 3 hours to 14.4mg. Find the half-life of fluorine-18.

Exercise III.8. A bone has lost 35% of its carbon-14. How old is the bone?

Exercise III.9. How much do you have to invest today at 3% compounded quarterly to obtain \$2,000 in return in 3 years?

Exercise III.10. \$500 is invested with continuous compounding. If \$692.01 is returned after 5 years, what is the interest rate?

Part IV

Trigonometric functions

Session 17

Trigonometric functions

17.1 Review of basic trigonometric definitions and facts

In this part, we will investigate trigonometric functions, such as $y = \sin(x)$, $y = \cos(x)$, and $y = \tan(x)$ in terms of their function theoretic aspects. Before we graph these functions, we recall the basic definitions and the main facts, which we will consider as known background material.

Definition 17.1. An angle can be expressed in **degree** or in **radian** measure. The relationship between degrees and radians is given by

$$\boxed{\pi = 180^\circ} \quad (17.1)$$

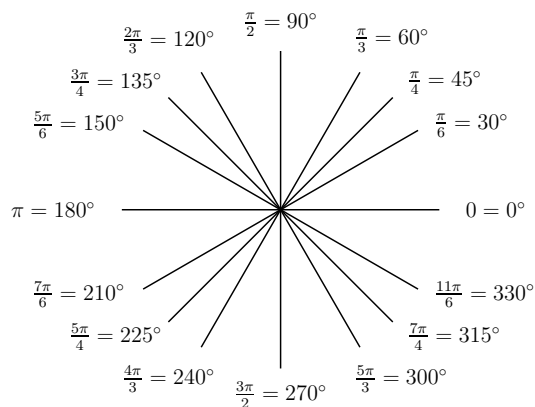

Definition 17.2. Let x be an angle. Consider the terminal side of the angle x , and assume that the point $P(a, b)$ is a point on the terminal side of x . If r is the distance from P to the origin $(0, 0)$, then we define the **sine**, **cosine**, **tangent**, **cosecant**, **secant**, and **cotangent** as follows:

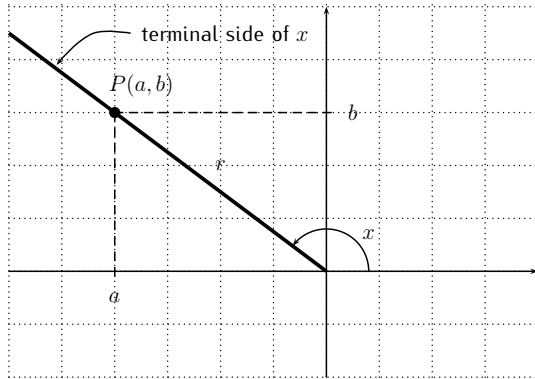

$$a^2 + b^2 = r^2$$

$$\Rightarrow \boxed{r = \sqrt{a^2 + b^2}}$$

$\sin(x) = \frac{b}{r}$	$\csc(x) = \frac{r}{b}$
$\cos(x) = \frac{a}{r}$	$\sec(x) = \frac{r}{a}$
$\tan(x) = \frac{b}{a}$	$\cot(x) = \frac{a}{b}$

There are some immediate consequences from the above definition.

$$\boxed{\csc(x) = \frac{1}{\sin(x)}}$$

$$\boxed{\sec(x) = \frac{1}{\cos(x)}}$$

$$\boxed{\tan(x) = \frac{\sin(x)}{\cos(x)}}$$

$$\boxed{\cot(x) = \frac{\cos(x)}{\sin(x)} = \frac{1}{\tan(x)}}$$

If we take $r = 1$ in the above we have the following 'unit circle' definition of sin and cos:

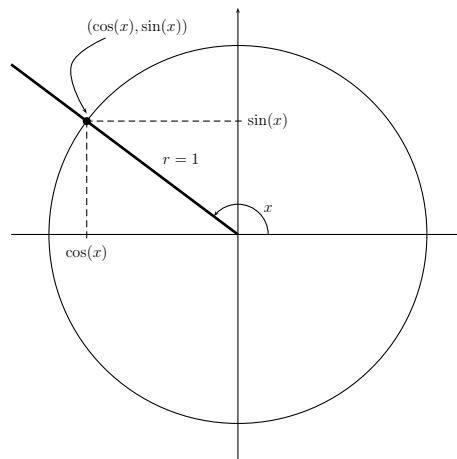

That is to say, that the point where the terminal side of the angle x intersects the unit circle is $(\cos(x), \sin(x))$ (which can serve as a definition of \cos and \sin as functions of x).

For the following, we use the short hand notation:

Definition 17.3. Define

$$\sin^2 \alpha := (\sin \alpha)^2, \quad \cos^2 \alpha := (\cos \alpha)^2, \quad \text{and} \quad \tan^2 \alpha := (\tan \alpha)^2.$$

From these definitions, we obtain that

$$\boxed{\sin^2(x) + \cos^2(x) = 1} \quad \boxed{\sec^2(x) = 1 + \tan^2(x)} \quad (17.2)$$

since $\sin^2(x) + \cos^2(x) = \left(\frac{b}{r}\right)^2 + \left(\frac{a}{r}\right)^2 = \frac{b^2+a^2}{r^2} = \frac{r^2}{r^2} = 1$, and, similarly, $1 + \tan^2(x) = 1 + \left(\frac{b}{a}\right)^2 = \frac{a^2+b^2}{a^2} = \frac{r^2}{a^2} = \left(\frac{r}{a}\right)^2 = \sec^2(x)$. Furthermore, we can see from the definition that

$$\begin{array}{ccc} \boxed{\sin(x + 2\pi) = \sin(x)} & \boxed{\sin(-x) = -\sin(x)} & \boxed{\sin(\pi - x) = \sin(x)} \\ \boxed{\cos(x + 2\pi) = \cos(x)} & \boxed{\cos(-x) = \cos(x)} & \boxed{\cos(\pi - x) = -\cos(x)} \end{array} \quad (17.3)$$

For a point $P(a, b)$ the x -coordinate a is positive when P is in quadrant I and IV, whereas the y -coordinate b is positive when P is in quadrant I and II. The length of the hypotenuse r is always positive. Thus the trigonometric functions are positive/negative according to the chart:

	Quadrant II	Quadrant I
$\sin(x)$ is positive	$\sin(x)$ is positive	$\sin(x)$ is positive
$\cos(x)$ is negative	$\cos(x)$ is negative	$\cos(x)$ is positive
$\tan(x)$ is negative	$\tan(x)$ is negative	$\tan(x)$ is positive
	Quadrant III	Quadrant IV
$\sin(x)$ is negative	$\sin(x)$ is negative	$\sin(x)$ is negative
$\cos(x)$ is negative	$\cos(x)$ is negative	$\cos(x)$ is positive
$\tan(x)$ is positive	$\tan(x)$ is positive	$\tan(x)$ is negative

There are two basic triangles that are used to calculate exact values of the trigonometric functions. These two triangles are the $45^\circ - 45^\circ - 90^\circ$ and $30^\circ - 60^\circ - 90^\circ$ triangles, which can be described with specific side lengths.

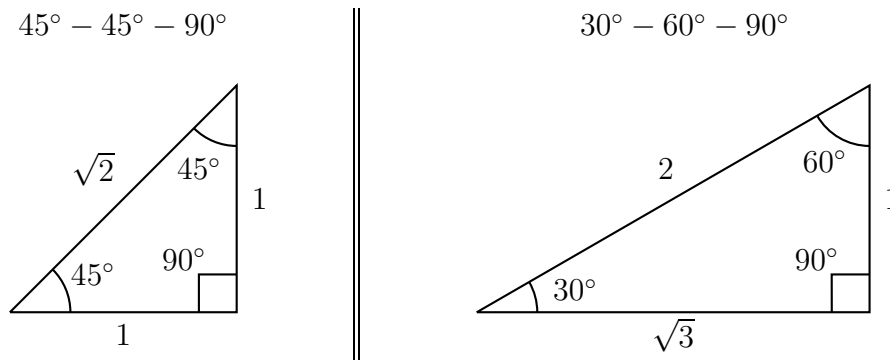

These basic triangles may be used to calculate the trigonometric functions of certain angles.

Example 17.4. Find $\sin(x)$, $\cos(x)$, and $\tan(x)$ for the angles

$$x = 30^\circ, \quad x = 45^\circ, \quad x = 60^\circ, \quad x = 90^\circ, \quad x = 0^\circ.$$

Solution. We draw the angle $x = 30^\circ$ in the plane, and use the special triangle to find a point on the terminal side of the angle. From this, we then read off the trigonometric functions. Here are the function values for 30° , 45° , and 60° .

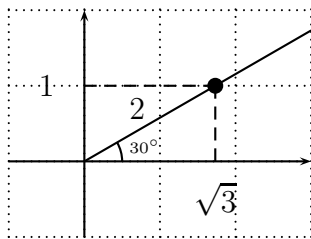

$$\sin(30^\circ) = \frac{b}{r} = \frac{1}{2}$$

$$\cos(30^\circ) = \frac{a}{r} = \frac{\sqrt{3}}{2}$$

$$\tan(30^\circ) = \frac{b}{a} = \frac{1}{\sqrt{3}} = \frac{\sqrt{3}}{3}$$

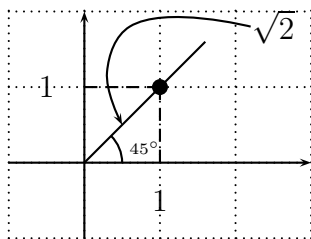

$$\sin(45^\circ) = \frac{b}{r} = \frac{1}{\sqrt{2}} = \frac{\sqrt{2}}{2}$$

$$\cos(45^\circ) = \frac{a}{r} = \frac{1}{\sqrt{2}} = \frac{\sqrt{2}}{2}$$

$$\tan(45^\circ) = \frac{b}{a} = \frac{1}{1} = 1$$

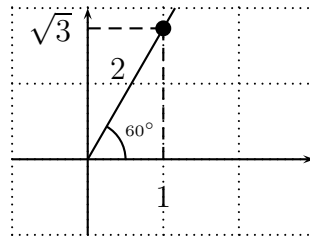

$$\sin(60^\circ) = \frac{b}{r} = \frac{\sqrt{3}}{2}$$

$$\cos(60^\circ) = \frac{a}{r} = \frac{1}{2}$$

$$\tan(60^\circ) = \frac{b}{a} = \frac{\sqrt{3}}{1} = \sqrt{3}$$

Here are the trigonometric functions for 90° and 0° .

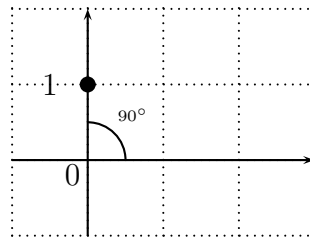

$$\sin(90^\circ) = \frac{b}{r} = \frac{1}{1} = 1$$

$$\cos(90^\circ) = \frac{a}{r} = \frac{0}{1} = 0$$

$$\tan(90^\circ) = \frac{b}{a} = \frac{1}{0} \text{ is undefined}$$

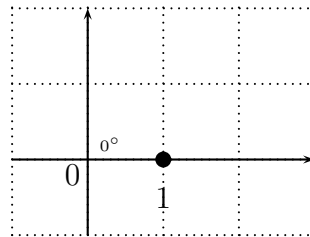

$$\sin(0^\circ) = \frac{b}{r} = \frac{0}{1} = 0$$

$$\cos(0^\circ) = \frac{a}{r} = \frac{1}{1} = 1$$

$$\tan(0^\circ) = \frac{b}{a} = \frac{0}{1} = 0$$

□

We collect the results of the previous example in a table:

x	$0 = 0^\circ$	$\frac{\pi}{6} = 30^\circ$	$\frac{\pi}{4} = 45^\circ$	$\frac{\pi}{3} = 60^\circ$	$\frac{\pi}{2} = 90^\circ$
$\sin(x)$	0	$\frac{1}{2}$	$\frac{\sqrt{2}}{2}$	$\frac{\sqrt{3}}{2}$	1
$\cos(x)$	1	$\frac{\sqrt{3}}{2}$	$\frac{\sqrt{2}}{2}$	$\frac{1}{2}$	0
$\tan(x)$	0	$\frac{\sqrt{3}}{3}$	1	$\sqrt{3}$	undef.

Note 17.5. There is an easy way to remember the function value given in the above table by writing the numerator of $\sin(x)$ as $\sqrt{0}, \sqrt{1}, \sqrt{2}, \sqrt{3}, \sqrt{4}$ in increasing order, and for $\cos(x)$ in decreasing order:

x	$0 = 0^\circ$	$\frac{\pi}{6} = 30^\circ$	$\frac{\pi}{4} = 45^\circ$	$\frac{\pi}{3} = 60^\circ$	$\frac{\pi}{2} = 90^\circ$
$\sin(x)$	$\frac{\sqrt{0}}{2}$	$\frac{\sqrt{1}}{2}$	$\frac{\sqrt{2}}{2}$	$\frac{\sqrt{3}}{2}$	$\frac{\sqrt{4}}{2}$
$\cos(x)$	$\frac{\sqrt{4}}{2}$	$\frac{\sqrt{3}}{2}$	$\frac{\sqrt{2}}{2}$	$\frac{\sqrt{1}}{2}$	$\frac{\sqrt{0}}{2}$

The values of $\tan(x)$ are then determined from this by $\tan(x) = \frac{\sin(x)}{\cos(x)}$:

x	$0 = 0^\circ$	$\frac{\pi}{6} = 30^\circ$	$\frac{\pi}{4} = 45^\circ$	$\frac{\pi}{3} = 60^\circ$	$\frac{\pi}{2} = 90^\circ$
$\tan(x)$	$\frac{0}{1} = 0$	$\frac{\frac{1}{2}}{\frac{\sqrt{3}}{2}} = \frac{1}{\sqrt{3}} = \frac{\sqrt{3}}{3}$	$\frac{\frac{\sqrt{2}}{2}}{\frac{\sqrt{2}}{2}} = 1$	$\frac{\frac{\sqrt{3}}{2}}{\frac{1}{2}} = \sqrt{3}$	" $\frac{1}{0}$ " is undef.

We can use the special $45^\circ - 45^\circ - 90^\circ$ and $30^\circ - 60^\circ - 90^\circ$ triangles to also find other values of the trigonometric functions.

Example 17.6. Find $\sin(x)$, $\cos(x)$, and $\tan(x)$ for the following angles.

a) $x = 240^\circ$, b) $x = 495^\circ$, c) $x = \frac{11\pi}{6}$, d) $x = \frac{-9\pi}{4}$

Solution. a) We graph the angle $x = 240^\circ$, and identify a special $30^\circ - 60^\circ - 90^\circ$ triangle using the terminal side of x .

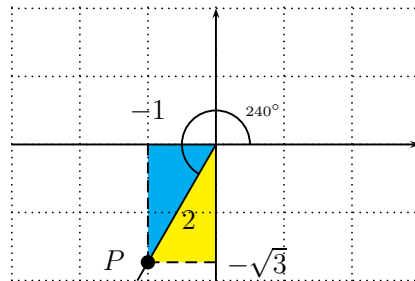

We identify a point P on the terminal side of x . This point P has coordinates $P(-1, -\sqrt{3})$, which can be seen by considering one of two $30^\circ - 60^\circ - 90^\circ$ triangles in the plane (shaded above). The length of the line segment from P to the origin $(0, 0)$ is 2. Thus, $a = -1$, $b = -\sqrt{3}$, $r = 2$. We get

$$\sin(240^\circ) = \frac{-\sqrt{3}}{2}, \quad \cos(240^\circ) = \frac{-1}{2}, \quad \tan(240^\circ) = \frac{-\sqrt{3}}{-1} = \sqrt{3}$$

b) The angle $x = 495^\circ$ is greater than 360° . However, the trigonometric functions are invariant under addition or subtraction of 360° :

$$\boxed{\sin(x \pm 360^\circ) = \sin(x)} \quad \boxed{\cos(x \pm 360^\circ) = \cos(x)} \quad \boxed{\tan(x \pm 360^\circ) = \tan(x)}$$

Since $495^\circ - 360^\circ = 135^\circ$, we have $\sin(495^\circ) = \sin(135^\circ)$, and similarly for \cos and \tan . Graphing the terminal side of x , and identifying a special

$45^\circ - 45^\circ - 90^\circ$ triangle, we find the coordinates of a point P on the terminal side with coordinates $P(-1, 1)$.

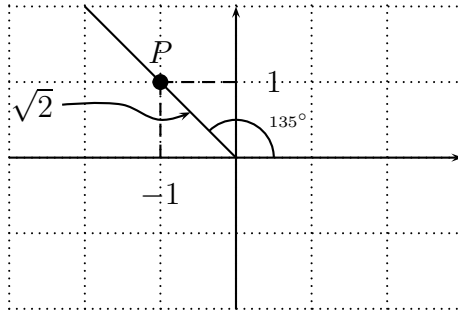

Therefore, $a = -1$, $b = 1$, $r = \sqrt{2}$. We obtain

$$\sin(495^\circ) = \frac{1}{\sqrt{2}} = \frac{\sqrt{2}}{2}, \quad \cos(495^\circ) = \frac{-1}{\sqrt{2}} = \frac{-\sqrt{2}}{2}, \quad \tan(495^\circ) = \frac{1}{-1} = -1$$

c) Converting $\frac{11\pi}{6}$ into degrees, we have

$$x = \frac{11\pi}{6} = \frac{11\pi}{6} \cdot \frac{180^\circ}{\pi} = 11 \cdot 30^\circ = 330^\circ.$$

Drawing the terminal side, we obtain the point P .

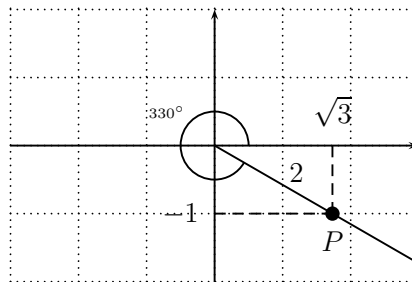

The point P has coordinates $P(\sqrt{3}, -1)$. Therefore, $a = \sqrt{3}$, $b = -1$, $r = 2$, and

$$\sin\left(\frac{11\pi}{6}\right) = \frac{-1}{2}, \quad \cos\left(\frac{11\pi}{6}\right) = \frac{\sqrt{3}}{2}, \quad \tan\left(\frac{11\pi}{6}\right) = \frac{-1}{\sqrt{3}} = \frac{-\sqrt{3}}{3}$$

d) Converting the angle $x = \frac{-9\pi}{4} = \frac{-9\pi}{4} \cdot \frac{180^\circ}{\pi} = -9 \cdot 45^\circ = -405^\circ$, we see that the trigonometric functions of x are the same as of $-405^\circ + 360^\circ = -45^\circ$,

and also of $-45^\circ + 360^\circ = 315^\circ$. We can draw either -45° or 315° to find a point P on the terminal side of x .

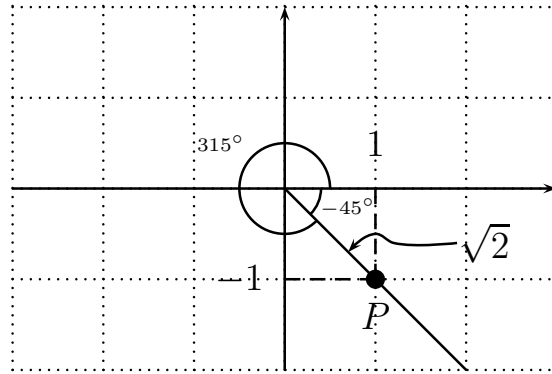

The point $P(1, -1)$ determines $a = 1$, $b = -1$, $r = \sqrt{2}$, and so

$$\begin{aligned}\sin\left(\frac{-9\pi}{4}\right) &= \frac{-1}{\sqrt{2}} = \frac{-\sqrt{2}}{2}, & \cos\left(\frac{-9\pi}{4}\right) &= \frac{1}{\sqrt{2}} = \frac{\sqrt{2}}{2}, \\ \tan\left(\frac{-9\pi}{4}\right) &= \frac{-1}{1} = -1\end{aligned}$$

□

17.2 sin, cos, and tan as functions

We now turn to function theoretic aspects of the trigonometric functions defined in the last section. In particular, we will be interested in understanding the graphs of the functions $y = \sin(x)$, $y = \cos(x)$, and $y = \tan(x)$. With an eye toward calculus, we will take the angles x in *radian* measure.

Example 17.7. We graph the functions $y = \sin(x)$, $y = \cos(x)$, and $y = \tan(x)$.

One way to proceed is to calculate and collect various function values in a table and then graph them. However, this is quite elaborate, as the following table shows.

x	0	$\frac{\pi}{6}$	$\frac{\pi}{4}$	$\frac{\pi}{3}$	$\frac{\pi}{2}$	$\frac{2\pi}{3}$	$\frac{3\pi}{4}$	$\frac{5\pi}{6}$	π	...
$\sin(x)$	0	$\frac{1}{2}$	$\frac{\sqrt{2}}{2}$	$\frac{\sqrt{3}}{2}$	1	$\frac{\sqrt{3}}{2}$	$\frac{\sqrt{2}}{2}$	$\frac{1}{2}$	0	...
$\cos(x)$	1	$\frac{\sqrt{3}}{2}$	$\frac{\sqrt{2}}{2}$	$\frac{1}{2}$	0	$-\frac{1}{2}$	$-\frac{\sqrt{2}}{2}$	$-\frac{\sqrt{3}}{2}$	-1	...
$\tan(x)$	0	$\frac{\sqrt{3}}{3}$	1	$\sqrt{3}$	undef.	$-\sqrt{3}$	-1	$-\frac{\sqrt{3}}{3}$	0	...

An easier approach is to use the TI-84 to graph each function. Before entering the function, we need to make sure that the calculator is in radian mode. For this, press the `mode` key, and in case the third item is set on *degree*, switch to *radian*, and press `enter`.

```

NORMAL SCI ENG
FLOAT 0 1 2 3 4 5 6 7 8 9
RADIAN DEGREE
FUNC PAR POL SEQ
CONNECTED DOT
SEQUENTIAL SIMUL
REAL a+bi re^θi
FULL HORIZ G-T
↓NEXT↓

```

```

NORMAL SCI ENG
FLOAT 0 1 2 3 4 5 6 7 8 9
RADIAN DEGREE
FUNC PAR POL SEQ
CONNECTED DOT
SEQUENTIAL SIMUL
REAL a+bi re^θi
FULL HORIZ G-T
↓NEXT↓

```

We may now enter the function $y = \sin(x)$ and study its graph.

```

Plot1 Plot2 Plot3
Y1= sin(X)
Y2=
Y3=
Y4=
Y5=
Y6=
Y7=

```

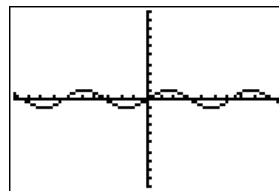

From this, we can make some immediate observations (which can also be seen using definition 17.2). First, the graph is bounded between -1 and $+1$, because by definition 17.2, we have $\sin(x) = \frac{b}{r}$ with $-r \leq b \leq r$, so that

$$-1 \leq \sin(x) \leq 1, \quad \text{for all } x.$$

We therefore change the window of the graph to display y 's between -2 and 2 , to get a closer view.

$$y = \sin(x)$$

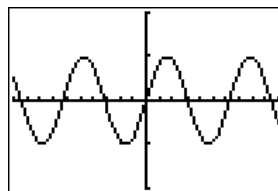

Second, we see that $y = \sin(x)$ is a *periodic* function with period 2π , since the function doesn't change its value when adding $360^\circ = 2\pi$ to its argument (and this is the smallest non-zero number with that property):

$$\sin(x + 2\pi) = \sin(x)$$

The graph of $y = \sin(x)$ has the following specific values:

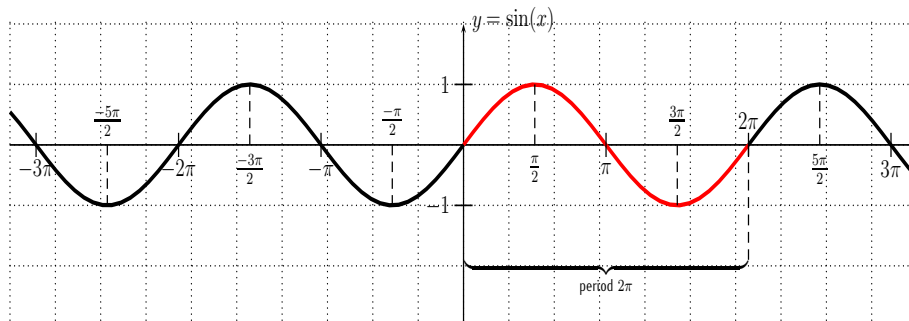

The graph of $y = \sin(x)$ has a period of 2π , and an amplitude of 1.

Similarly, we can graph the function $y = \cos(x)$. Since $-1 \leq \cos(x) \leq 1$ for all x , we graph it also with the zoomed window setting.

$$y = \cos(x)$$

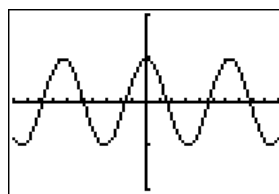

We see that $y = \cos(x)$ is also periodic with period 2π , that is

$$\cos(x + 2\pi) = \cos(x),$$

and $y = \cos(x)$ also has an amplitude of 1, since $-1 \leq \cos(x) \leq 1$.

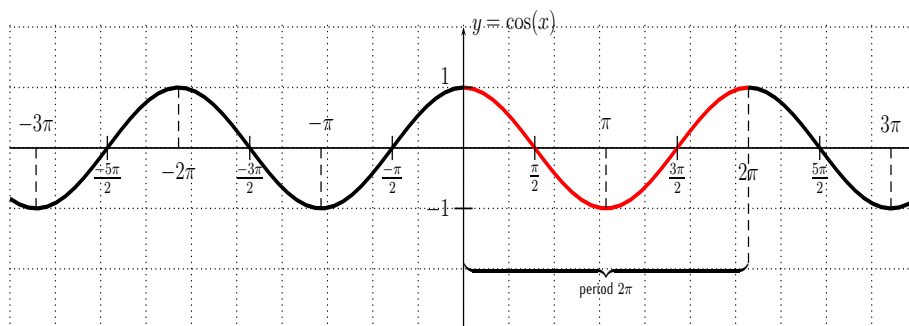

Indeed, the graph of $y = \cos(x)$ is that of $y = \sin(x)$ shifted to the left by $\frac{\pi}{2}$. The reason for this is that

$$\cos(x) = \sin\left(x + \frac{\pi}{2}\right) \quad (17.4)$$

Many other properties of \sin and \cos can be observed from the graph (or from the unit circle definition). For example, recalling Observation 5.11 from page 72, we see that the sine function is an odd function, since the graph of $y = \sin(x)$ is symmetric with respect to the origin. Similarly, the cosine function is an even function, since the graph of $y = \cos(x)$ is symmetric with respect to the y -axis. Algebraically, Definition 5.9 from page 71 therefore shows that these functions satisfy the following relations:

$$\boxed{\sin(-x) = -\sin(x)} \quad \text{and} \quad \boxed{\cos(-x) = \cos(x)} \quad (17.5)$$

Finally, we come to the graph of $y = \tan(x)$. Graphing this function in the standard window, we obtain:

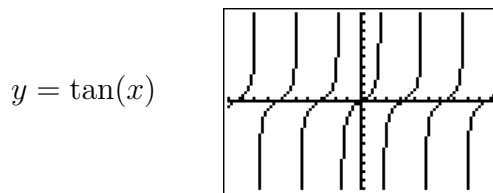

Zooming into this graph, we see that $y = \tan(x)$ has vertical asymptotes $x = \frac{\pi}{2} \approx 1.6$ and $x = -\frac{\pi}{2} \approx -1.6$.

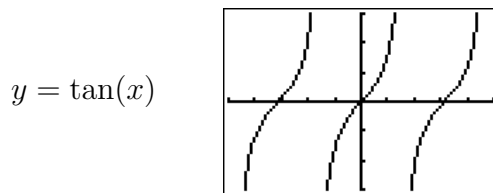

This is also supported by the fact that $\tan(\frac{\pi}{2})$ and $\tan(-\frac{\pi}{2})$ are undefined. The graph of $y = \tan(x)$ with some more specific function values is shown

below.

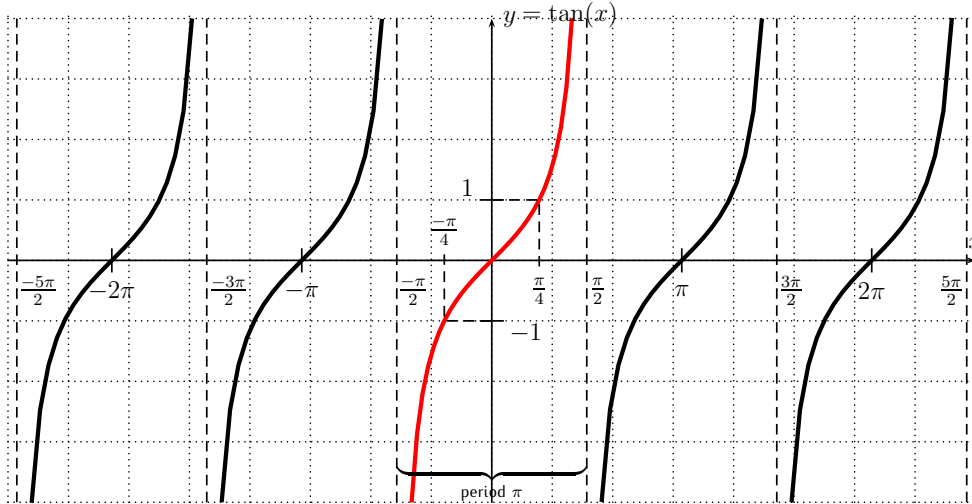

We see that the tangent is periodic with a period of π :

$$\tan(x + \pi) = \tan(x) \quad (17.6)$$

There are vertical asymptotes: $x = \frac{\pi}{2}, \frac{-\pi}{2}, \frac{3\pi}{2}, \frac{-3\pi}{2}, \frac{5\pi}{2}, \frac{-5\pi}{2}, \dots$, or, in short

$$\text{asymptotes of } y = \tan(x) : \quad x = n \cdot \frac{\pi}{2}, \text{ where } n = \pm 1, \pm 3, \pm 5, \dots$$

Furthermore, the tangent is an odd function, since it is symmetric with respect to the origin (see Observation 5.11):

$$\boxed{\tan(-x) = -\tan(x)} \quad (17.7)$$

Recall from section 5.2 how changing the formula of a function affects the graph of the function, such as:

- the graph of $c \cdot f(x)$ (for $c > 0$) is the graph of $f(x)$ stretched away from the x -axis by a factor c (or compressed when $0 < c < 1$)
- the graph of $f(c \cdot x)$ (for $c > 0$) is the graph of $f(x)$ compressed towards the y -axis by a factor c (or stretched away the y -axis when $0 < c < 1$)
- graph of $f(x) + c$ is the graph of $f(x)$ shifted up by c (or down when $c < 0$)

- graph of $f(x + c)$ is the graph of $f(x)$ shifted to the left by c (or to the right when $c < 0$)

With this we can graph some variations of the basic trigonometric functions.

Example 17.8. Graph the functions:

$$f(x) = \sin(x) + 3, \quad g(x) = 4 \cdot \sin(x), \quad h(x) = \sin(x + 2), \quad i(x) = \sin(3x),$$

$$j(x) = 2 \cdot \cos(x) + 3, \quad k(x) = \cos(2x - \pi), \quad l(x) = \tan(x + 2) + 3$$

Solution. The functions f , g , h , and i have graphs that are variations of the basic $y = \sin(x)$ graph. The graph of $f(x) = \sin(x) + 3$, shifts the graph of $y = \sin(x)$ up by 3, whereas the graph of $g(x) = 4 \cdot \sin(x)$ stretches $y = \sin(x)$ away from the x -axis.

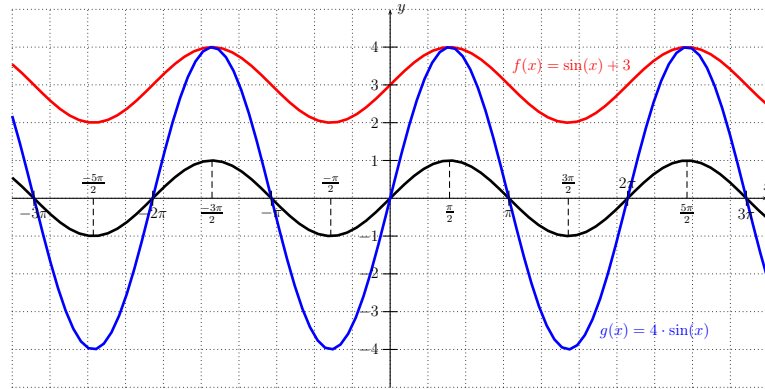

The graph of $h(x) = \sin(x + 2)$ shifts the graph of $y = \sin(x)$ to the left by 2, and $i(x) = \sin(3x)$ compresses $y = \sin(x)$ towards the y -axis.

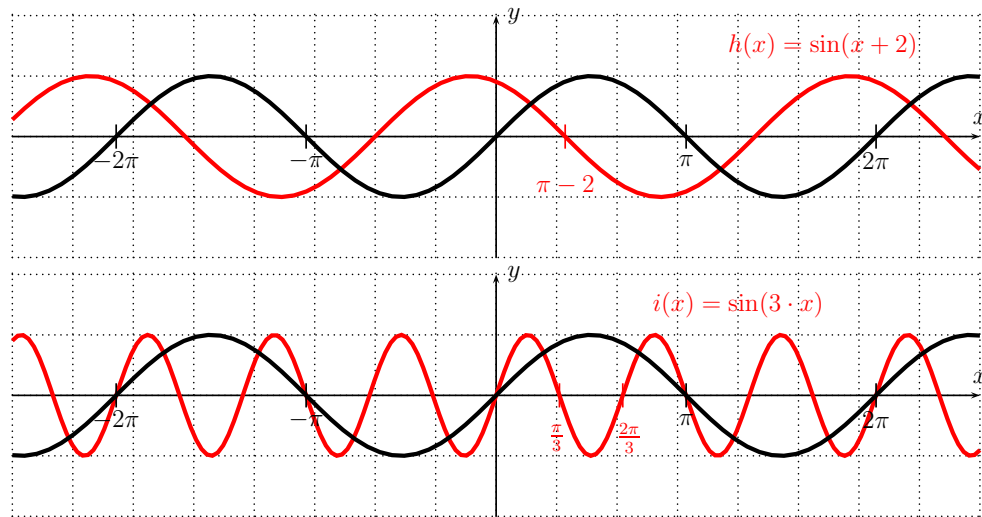

Next, $j(x) = 2 \cdot \cos(x) + 3$ has a graph of $y = \cos(x)$ stretched by a factor 2 away from the x -axis, and shifted up by 3.

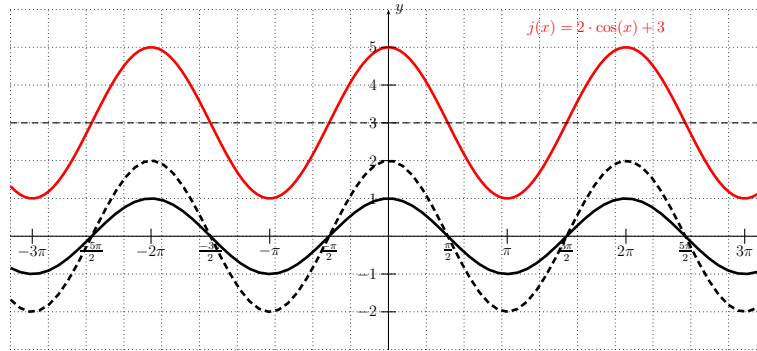

For the graph of $k(x) = \cos(2x - \pi) = \cos(2 \cdot (x - \frac{\pi}{2}))$, we need to compress the graph of $y = \cos(x)$ by a factor 2 (we obtain the graph of the function $y = \cos(2x)$) and then shift this by $\frac{\pi}{2}$ to the right.

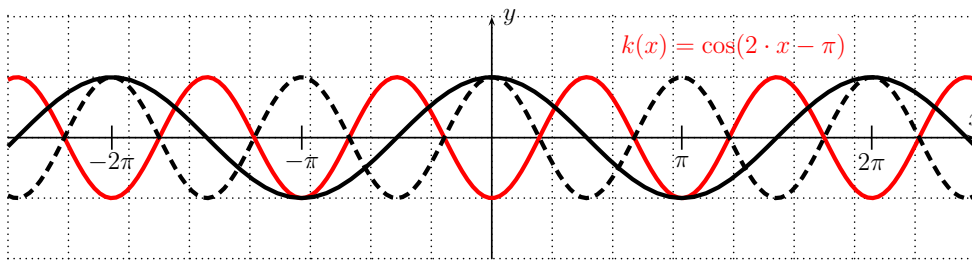

We will explore this case below in more generality. In fact, whenever $y = \cos(b \cdot x + c) = \cos(b \cdot (x - \frac{-c}{b}))$, the graph of $y = \cos(x)$ is shifted to the right by $\frac{-c}{b}$, and compressed by a factor b , so that it has a period of $\frac{2\pi}{b}$.

Finally, $l(x) = \tan(x + 2) + 3$ shifts the graph of $y = \tan(x)$ up by 3 and to the left by 2.

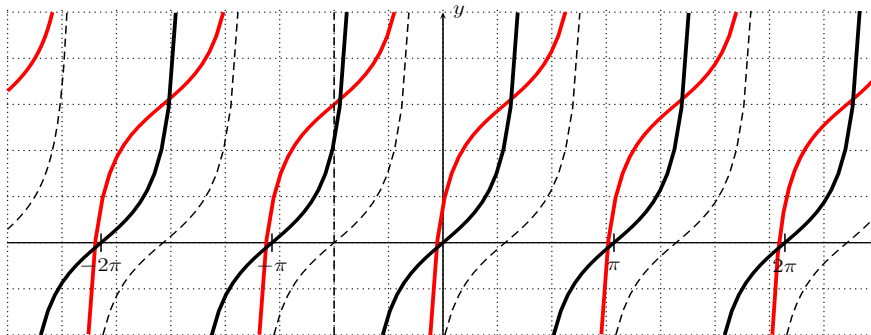

□

We collect some of the observations that were made in the above examples in the following definition.

Definition 17.9. Let f be one of the functions:

$$f(x) = a \cdot \sin(b \cdot x + c) \quad \text{or} \quad f(x) = a \cdot \cos(b \cdot x + c)$$

The number $|a|$ is called the **amplitude**, the number $|\frac{2\pi}{b}|$ is the **period**, and the number $\frac{-c}{b}$ is called the **phase shift**.

In physical applications, the period is sometimes denoted by $T = |\frac{2\pi}{b}|$ and the **frequency** is the reciprocal

$$f = \frac{1}{T}.$$

Using the amplitude, period and phase-shift, we can draw the graph of, for example, a function $f(x) = a \cdot \sin(b \cdot x + c)$ over one period by shifting the graph of $\sin(x)$ by the phase-shift $\frac{-c}{b}$ to the right, then marking one full period of length $|\frac{2\pi}{b}|$, and then drawing the basic $\sin(x)$ graph with an amplitude of a (or the reflected graph of $-\sin(x)$ when a is negative).

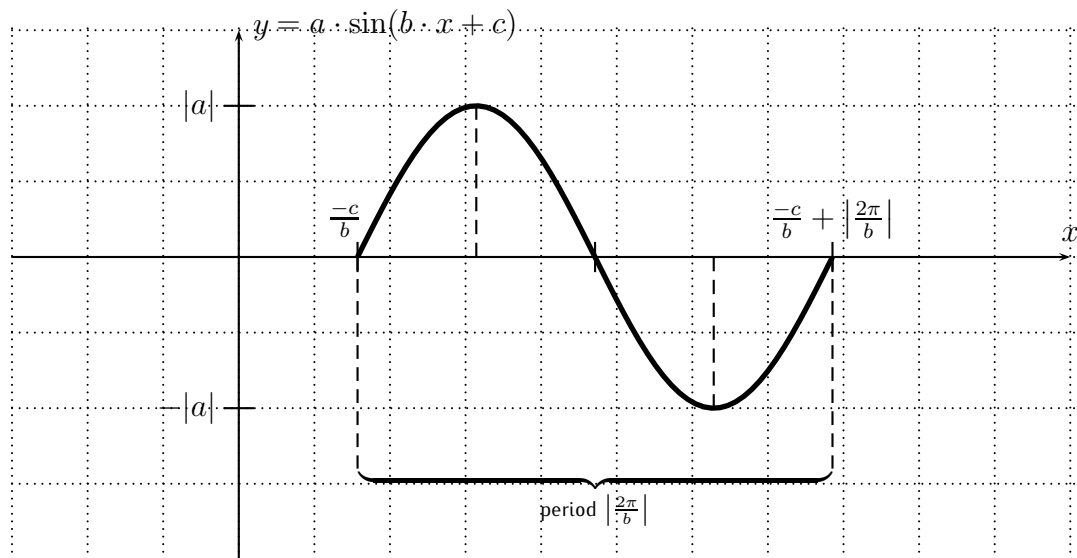

The zero(s), maxima, and minima of the graph within the drawn period can be found by calculating the midpoint between $(\frac{-c}{b}, 0)$ and $(\frac{-c}{b} + \frac{2\pi}{b}, 0)$ and midpoints between these and the resulting midpoint.

A similar graph can be obtained for $f(x) = a \cdot \cos(b \cdot x + c)$ by replacing the $\sin(x)$ graph with the $\cos(x)$ graph over one period.

Example 17.10. Find the amplitude, period, and phase-shift, and sketch the graph over one full period.

- a) $f(x) = 3 \sin(2x)$ b) $f(x) = -2 \cos(\pi \cdot x)$
 c) $f(x) = \cos(x - 2)$ d) $f(x) = \cos(2x + \pi)$
 e) $f(x) = -4 \cdot \sin\left(\frac{x}{2} + 3\right)$ f) $f(x) = 3 \sin(-2x)$

Solution. a) The amplitude is $|3| = 3$, and since $f(x) = 3 \cdot \sin(2 \cdot x + 0)$, it is $b = 2$ and $c = 0$, so that the period is $\left|\frac{2\pi}{2}\right| = \pi$ and the phase-shift is $\frac{-0}{2} = 0$. This is also supported by graphing the function with the calculator; in particular the graph repeats after one full period, which is at $\pi \approx 3.1$.

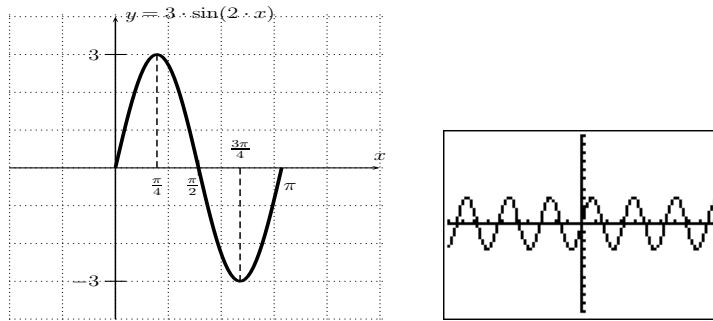

b) For $f(x) = -2 \cos(\pi \cdot x)$, the amplitude is $|-2| = 2$, the period is $\left|\frac{2\pi}{\pi}\right| = 2$, and the phase-shift is 0. Note, that the first coefficient is negative, so that the $\cos(x)$ has to be reflected about the x -axis. One full period is graphed below with a solid line (and the continuation of the graph is dashed). This graph is again supported by the graph and table as given by the calculator.

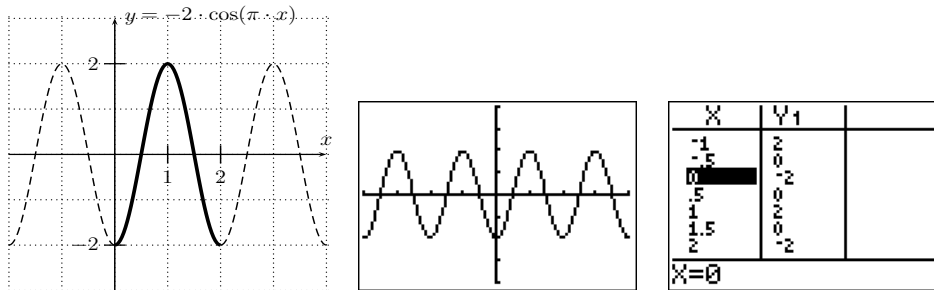

c) The amplitude of $f(x) = \cos(x - 2)$ is 1, the period is 2π , and the

phase-shift is $\frac{-(-2)}{1} = 2$. The graph over one period is displayed below.

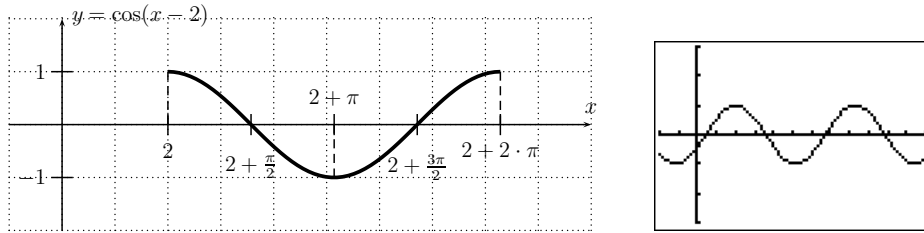

The minimum of the function f in this period is given by taking the value in the middle of the interval $[2, 2 + 2\pi]$, that is at $2 + \pi$. With this, the zeros are given by taking the value in the middle of the intervals $[2, 2 + \pi]$ and $[2 + \pi, 2 + 2\pi]$, which are at $2 + \frac{\pi}{2}$ and $2 + \frac{3\pi}{2}$.

d) The function $f(x) = \cos(2x + \pi)$ has amplitude 1, period $\frac{2\pi}{2} = \pi$, and phase-shift $\frac{-\pi}{2}$. We may thus draw the graph over one period from $\frac{-\pi}{2}$ to $\frac{-\pi}{2} + \pi = \frac{\pi}{2}$; see graph on the left below. However, we may also graph the function over another full period, such as $[0, \pi]$ (see the graph on the right).

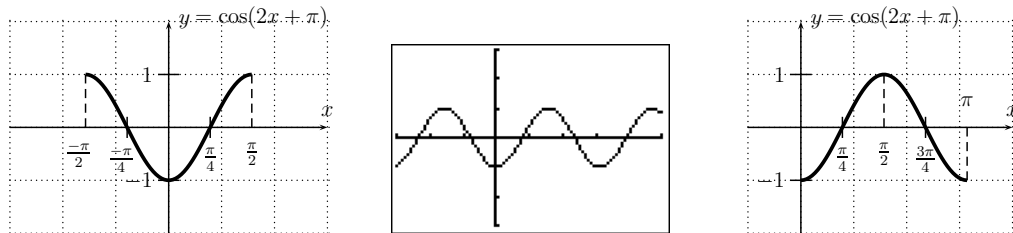

e) The graph of $f(x) = -4 \cdot \sin\left(\frac{x}{2} + 3\right)$ has an amplitude of $|-4| = 4$, a period of $\frac{2\pi}{\frac{1}{2}} = 4\pi$, and a phase shift of $\frac{-3}{\frac{1}{2}} = -6$. Using this information, and confirming this with the calculator, we can draw one full period of the graph of f .

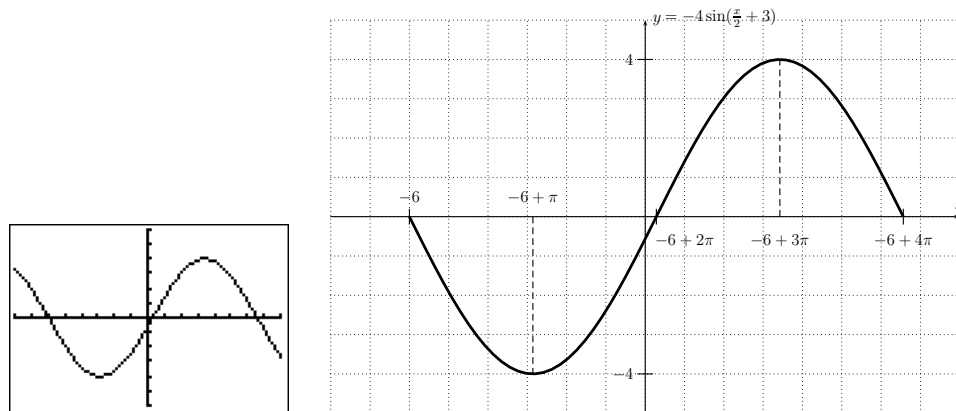

f) For $f(x) = 3 \sin(-2x)$, we have an amplitude of 3, a period of $\left| \frac{2\pi}{-2} \right| = \pi$ and a phase-shift of $\frac{-0}{-2} = 0$. Comparing this with example (a) above, we see that we have the same data as for the function $y = 3 \sin(2x)$ from part (a). However, in this case, we have to draw the sine function over one period moving to the left, which means that the graph has to start the period as a decreasing function. This can also be seen by observing that the sine function is an odd function, that is equation (17.5), so that

$$f(x) = 3 \sin(-2x) = -3 \sin(2x).$$

The graph is therefore drawn as follows.

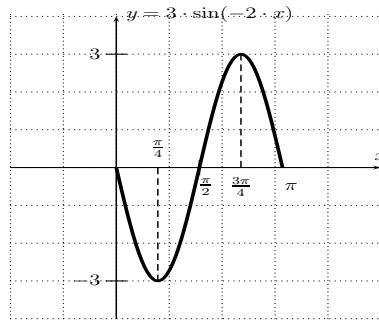

□

17.3 Exercises

Exercise 17.1. Find $\sin(x)$, $\cos(x)$, and $\tan(x)$ for the following angles.

- a) $x = 120^\circ$, b) $x = 390^\circ$, c) $x = -150^\circ$, d) $x = -45^\circ$
 e) $x = 1050^\circ$, f) $x = -810^\circ$, g) $x = \frac{5\pi}{4}$, h) $x = \frac{5\pi}{6}$
 i) $x = \frac{10\pi}{3}$, j) $x = \frac{15\pi}{2}$, k) $x = \frac{-\pi}{6}$, l) $x = \frac{-54\pi}{8}$

Exercise 17.2. Graph the function, and describe how the graph can be obtained from one of the basic graphs $y = \sin(x)$, $y = \cos(x)$, or $y = \tan(x)$.

- a) $f(x) = \sin(x) + 2$ b) $f(x) = \cos(x - \pi)$ c) $f(x) = \tan(x) - 4$
 d) $f(x) = 5 \cdot \sin(x)$ e) $f(x) = \cos(2 \cdot x)$ f) $f(x) = \sin(x - 2) - 5$

Exercise 17.3. Identify the formulas with the graphs.

$$f(x) = \sin(x) + 2, \quad g(x) = \tan(x - 1), \quad h(x) = 3 \sin(x),$$

$$i(x) = 3 \cos(x), \quad j(x) = \cos(x - \pi), \quad k(x) = \tan(x) - 1,$$

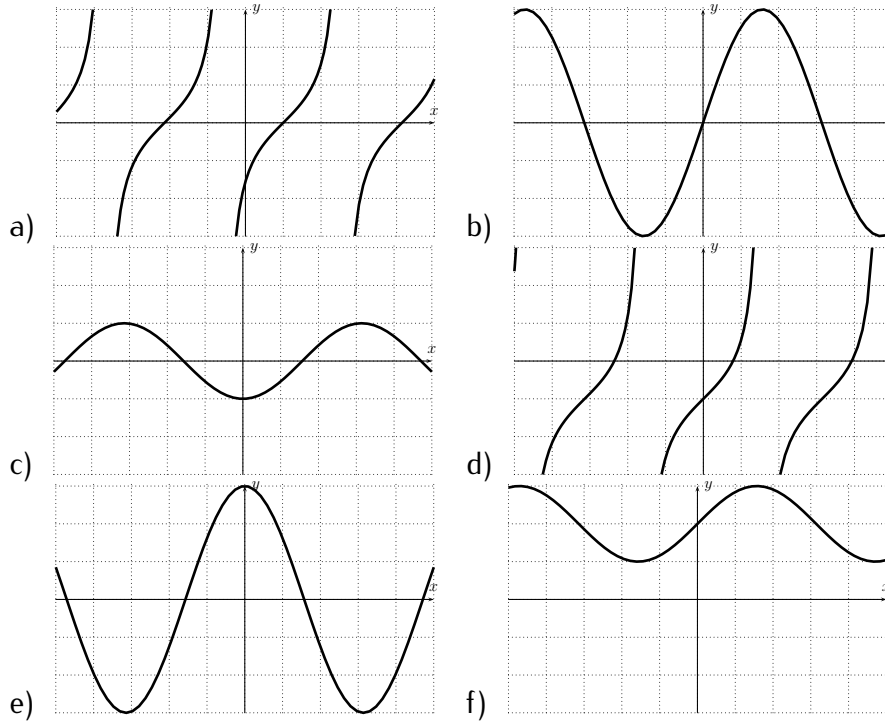

Exercise 17.4. Find the formula of a function whose graph is the one displayed below.

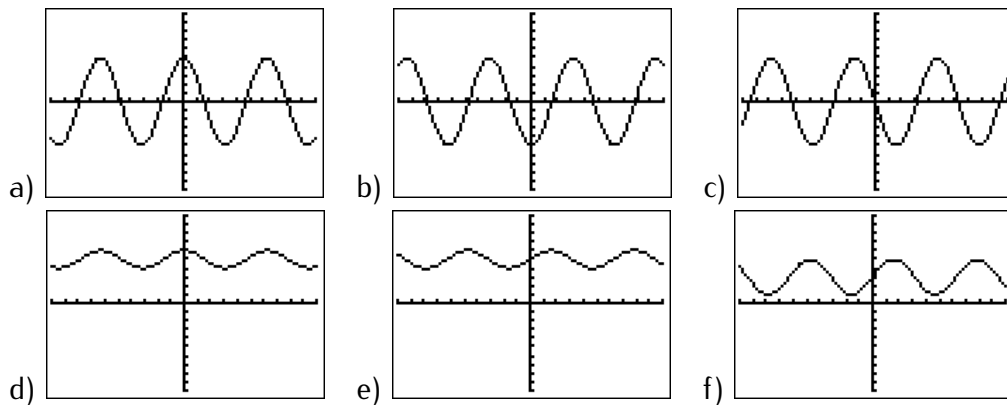

Exercise 17.5. Find the amplitude, period, and phase-shift of the function.

a) $f(x) = 5 \sin(2x + 3)$ b) $f(x) = \sin(\pi x - 5)$ c) $f(x) = 6 \sin(4x)$
d) $f(x) = -2 \cos(x + \frac{\pi}{4})$ e) $f(x) = 8 \cos(2x - 6)$ f) $f(x) = 3 \sin(\frac{x}{4})$
g) $f(x) = -\cos(x + 2)$ h) $f(x) = 7 \sin(\frac{2\pi}{5}x - \frac{6\pi}{5})$ i) $f(x) = \cos(-2x)$

Exercise 17.6. Find the amplitude, period, and phase-shift of the function. Use this information to graph the function over a full period. Label all maxima, minima, and zeros of the function.

a) $y = 5 \cos(2x)$ b) $y = 4 \sin(\pi x)$ c) $y = 2 \sin(\frac{2\pi}{3}x)$
d) $y = \cos(2x - \pi)$ e) $y = \cos(\pi x - \pi)$ f) $y = -6 \cos(-\frac{x}{4})$
g) $y = -\cos(4x + \pi)$ h) $y = 7 \sin(x + \frac{\pi}{4})$ i) $y = 5 \cos(x + \frac{3\pi}{2})$
j) $y = 4 \sin(5x - \pi)$ k) $y = -3 \cos(2\pi x - 4)$ l) $y = 7 \sin(\frac{1}{4}x + \frac{\pi}{4})$
m) $y = \cos(3x - 4\pi)$ n) $y = 2 \sin(\frac{1}{5}x - \frac{\pi}{10})$ o) $y = \frac{1}{3} \cos(\frac{14}{5}x - \frac{6\pi}{5})$

Session 18

Addition of angles and multiple angle formulas

18.1 Addition and subtraction of angles

In the previous section we found exact values of the trigonometric functions for specific angles of $0, \frac{\pi}{3}, \frac{\pi}{4}, \frac{\pi}{6}$ plus possibly any multiple of $\frac{\pi}{2}$. Using these values, we can find many other values of trigonometric functions via the following addition and subtraction of angles formulas, which we state now.

Proposition 18.1. For any angles α and β , we have

$$\begin{aligned}\sin(\alpha + \beta) &= \sin \alpha \cos \beta + \cos \alpha \sin \beta \\ \sin(\alpha - \beta) &= \sin \alpha \cos \beta - \cos \alpha \sin \beta \\ \cos(\alpha + \beta) &= \cos \alpha \cos \beta - \sin \alpha \sin \beta \\ \cos(\alpha - \beta) &= \cos \alpha \cos \beta + \sin \alpha \sin \beta \\ \tan(\alpha + \beta) &= \frac{\tan \alpha + \tan \beta}{1 - \tan \alpha \tan \beta} \\ \tan(\alpha - \beta) &= \frac{\tan \alpha - \tan \beta}{1 + \tan \alpha \tan \beta}\end{aligned}$$

Proof. We start with the proof of the formulas for $\sin(\alpha + \beta)$ and $\cos(\alpha + \beta)$ when α and β are angles between 0 and $\frac{\pi}{2} = 90^\circ$. We prove the addition formulas (for $\alpha, \beta \in (0, \frac{\pi}{2})$) in a quite elementary way, and then show that the addition formulas also hold for arbitrary angles α and β .

To find $\sin(\alpha + \beta)$, consider the following setup.

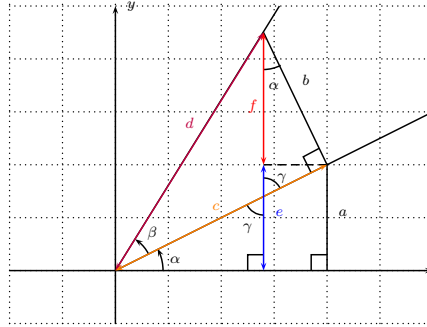

Note, that there are vertically opposite angles, labelled by γ , which are therefore equal. These angles are angles in two right triangles, with the third angle being α . We therefore see that the angle α appears again as the angle among the sides b and f . With this, we can now calculate $\sin(\alpha + \beta)$.

$$\begin{aligned}\sin(\alpha + \beta) &= \frac{\text{opposite}}{\text{hypotenuse}} = \frac{e + f}{d} = \frac{e}{d} + \frac{f}{d} = \frac{a}{d} + \frac{f}{d} = \frac{a}{c} \cdot \frac{c}{d} + \frac{f}{b} \cdot \frac{b}{d} \\ &= \sin(\alpha) \cos(\beta) + \cos(\alpha) \sin(\beta)\end{aligned}$$

The above figure displays the situation when $\alpha + \beta \leq \frac{\pi}{2}$. There is a similar figure for $\frac{\pi}{2} < \alpha + \beta < \pi$. (We recommend as an exercise to draw the corresponding figure for the case of $\frac{\pi}{2} < \alpha + \beta < \pi$.)

Next, we prove the addition formula for $\cos(\alpha + \beta)$. The following figure depicts the relevant objects.

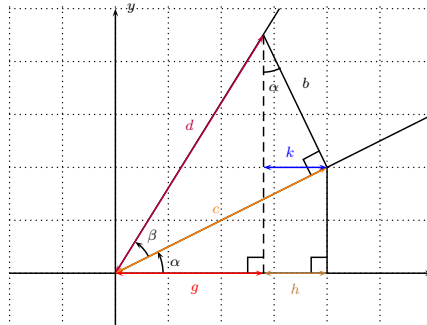

We calculate $\cos(\alpha + \beta)$ as follows.

$$\begin{aligned}\cos(\alpha + \beta) &= \frac{\text{adjacent}}{\text{hypotenuse}} = \frac{g}{d} = \frac{g + h}{d} - \frac{h}{d} = \frac{g + h}{d} - \frac{k}{d} = \frac{g + h}{c} \cdot \frac{c}{d} - \frac{k}{b} \cdot \frac{b}{d} \\ &= \cos(\alpha) \cos(\beta) - \sin(\alpha) \sin(\beta)\end{aligned}$$

Again, there is a corresponding figure when the angle $\alpha + \beta$ is greater than $\frac{\pi}{2}$. (We encourage the student to check the addition formula for this situation as well.)

We therefore have proved the addition formulas for $\sin(\alpha + \beta)$ and $\cos(\alpha + \beta)$ when α and β are angles between 0 and $\frac{\pi}{2}$, which we will now extend to all angles α and β . First, note that the addition formulas are trivially true when α or β are 0. (Check this!) Now, by observing that $\sin(x)$ and $\cos(x)$ can be converted to each other via shifts of $\frac{\pi}{2}$, (or, alternatively, by using the identities (17.3) and (17.4)), we obtain, that

$$\sin\left(x + \frac{\pi}{2}\right) = \cos x, \quad \cos\left(x + \frac{\pi}{2}\right) = -\sin(x),$$

254 SESSION 18. ADDITION OF ANGLES AND MULTIPLE ANGLES

$$\sin\left(x - \frac{\pi}{2}\right) = -\cos x, \quad \cos\left(x - \frac{\pi}{2}\right) = \sin(x).$$

With this, we extend the addition identities for α by $\pm \frac{\pi}{2}$ as follows:

$$\begin{aligned} \sin\left(\left(\alpha + \frac{\pi}{2}\right) + \beta\right) &= \sin\left(\alpha + \beta + \frac{\pi}{2}\right) = \cos(\alpha + \beta) = \cos(\alpha)\cos(\beta) - \sin(\alpha)\sin(\beta) \\ &= \sin\left(\alpha + \frac{\pi}{2}\right)\cos(\beta) + \cos\left(\alpha + \frac{\pi}{2}\right)\sin(\beta), \\ \sin\left(\left(\alpha - \frac{\pi}{2}\right) + \beta\right) &= \sin\left(\alpha + \beta - \frac{\pi}{2}\right) = -\cos(\alpha + \beta) = -\cos(\alpha)\cos(\beta) + \sin(\alpha)\sin(\beta) \\ &= \sin\left(\alpha - \frac{\pi}{2}\right)\cos(\beta) + \cos\left(\alpha - \frac{\pi}{2}\right)\sin(\beta), \\ \cos\left(\left(\alpha + \frac{\pi}{2}\right) + \beta\right) &= \cos\left(\alpha + \beta + \frac{\pi}{2}\right) = -\sin(\alpha + \beta) = -\sin(\alpha)\cos(\beta) - \cos(\alpha)\sin(\beta) \\ &= \cos\left(\alpha + \frac{\pi}{2}\right)\cos(\beta) - \sin\left(\alpha + \frac{\pi}{2}\right)\sin(\beta), \\ \cos\left(\left(\alpha - \frac{\pi}{2}\right) + \beta\right) &= \cos\left(\alpha + \beta - \frac{\pi}{2}\right) = \sin(\alpha + \beta) = \sin(\alpha)\cos(\beta) + \cos(\alpha)\sin(\beta) \\ &= \cos\left(\alpha - \frac{\pi}{2}\right)\cos(\beta) - \sin\left(\alpha - \frac{\pi}{2}\right)\sin(\beta). \end{aligned}$$

There are similar proofs to extend the identities for β . An induction argument shows the validity of the addition formulas for arbitrary angles α and β .

The remaining formulas now follow via the use of trigonometric identities.

$$\tan(\alpha + \beta) = \frac{\sin(\alpha + \beta)}{\cos(\alpha + \beta)} = \frac{\sin \alpha \cos \beta + \cos \alpha \sin \beta}{\cos \alpha \cos \beta - \sin \alpha \sin \beta} = \frac{\frac{\sin \alpha \cos \beta + \cos \alpha \sin \beta}{\cos \alpha \cos \beta}}{\frac{\cos \alpha \cos \beta - \sin \alpha \sin \beta}{\cos \alpha \cos \beta}} = \frac{\frac{\sin \alpha}{\cos \alpha} + \frac{\sin \beta}{\cos \beta}}{1 - \frac{\sin \alpha \sin \beta}{\cos \alpha \cos \beta}}$$

This shows that $\tan(\alpha + \beta) = \frac{\tan \alpha + \tan \beta}{1 - \tan \alpha \tan \beta}$. For the relations with $\alpha - \beta$, we use the fact that \sin and \tan are odd functions, whereas \cos is an even function, see identities (17.5) and (17.7).

$$\begin{aligned} \sin(\alpha - \beta) &= \sin(\alpha + (-\beta)) = \sin(\alpha)\cos(-\beta) + \cos(\alpha)\sin(-\beta) = \sin \alpha \cos \beta - \cos \alpha \sin \beta, \\ \cos(\alpha - \beta) &= \cos(\alpha + (-\beta)) = \cos(\alpha)\cos(-\beta) - \sin(\alpha)\sin(-\beta) = \cos \alpha \cos \beta + \sin \alpha \sin \beta, \\ \tan(\alpha - \beta) &= \tan(\alpha + (-\beta)) = \frac{\tan(\alpha) + \tan(-\beta)}{1 - \tan(\alpha)\tan(-\beta)} = \frac{\tan \alpha - \tan \beta}{1 + \tan \alpha \tan \beta}. \end{aligned}$$

This completes the proof of the proposition. □

Before giving examples of the above proposition, we recall the elementary function values of the \sin , \cos , and \tan from the previous section:

x	$0 = 0^\circ$	$\frac{\pi}{6} = 30^\circ$	$\frac{\pi}{4} = 45^\circ$	$\frac{\pi}{3} = 60^\circ$	$\frac{\pi}{2} = 90^\circ$	$\pi = 180^\circ$
$\sin(x)$	0	$\frac{1}{2}$	$\frac{\sqrt{2}}{2}$	$\frac{\sqrt{3}}{2}$	1	0
$\cos(x)$	1	$\frac{\sqrt{3}}{2}$	$\frac{\sqrt{2}}{2}$	$\frac{1}{2}$	0	-1
$\tan(x)$	0	$\frac{\sqrt{3}}{3}$	1	$\sqrt{3}$	undef.	0

Example 18.2. Find the exact values of the trigonometric functions.

$$\text{a) } \cos\left(\frac{\pi}{12}\right) \quad \text{b) } \tan\left(\frac{5\pi}{12}\right) \quad \text{c) } \cos\left(\frac{11\pi}{12}\right)$$

Solution. a) The key is to realize the angle $\frac{\pi}{12}$ as a sum or difference of angles with known trigonometric function values. Note, that $\frac{\pi}{3} - \frac{\pi}{4} = \frac{4\pi - 3\pi}{12} = \frac{\pi}{12}$, so that

$$\begin{aligned} \cos\left(\frac{\pi}{12}\right) &= \cos\left(\frac{\pi}{3} - \frac{\pi}{4}\right) = \cos\frac{\pi}{3} \cos\frac{\pi}{4} + \sin\frac{\pi}{3} \sin\frac{\pi}{4} \\ &= \frac{1}{2} \cdot \frac{\sqrt{2}}{2} + \frac{\sqrt{3}}{2} \cdot \frac{\sqrt{2}}{2} = \frac{\sqrt{2}}{4} + \frac{\sqrt{6}}{4} = \frac{\sqrt{2} + \sqrt{6}}{4} \end{aligned}$$

We remark that the last expression is in the simplest form and *cannot* be simplified any further.

b) Again we can write the angle $\frac{5\pi}{12}$ as a sum involving only special angles given in the table above: $\frac{5\pi}{12} = \frac{2\pi}{12} + \frac{3\pi}{12} = \frac{\pi}{6} + \frac{\pi}{4}$. Therefore,

$$\begin{aligned} \tan\left(\frac{5\pi}{12}\right) &= \tan\left(\frac{\pi}{6} + \frac{\pi}{4}\right) = \frac{\tan\frac{\pi}{6} + \tan\frac{\pi}{4}}{1 - \tan\frac{\pi}{6} \tan\frac{\pi}{4}} = \frac{\frac{\sqrt{3}}{3} + 1}{1 - \frac{\sqrt{3}}{3} \cdot 1} \\ &= \frac{\frac{\sqrt{3}+3}{3}}{\frac{3-\sqrt{3}}{3}} = \frac{\sqrt{3}+3}{3} \cdot \frac{3}{3-\sqrt{3}} = \frac{\sqrt{3}+3}{3-\sqrt{3}} \end{aligned}$$

Here, we may simplify the last expression further by rationalizing the denominator. This is done by multiplying $(3 + \sqrt{3})$ to numerator and denominator.

$$\begin{aligned} \tan\left(\frac{5\pi}{12}\right) &= \frac{(\sqrt{3}+3) \cdot (3+\sqrt{3})}{(3-\sqrt{3}) \cdot (3+\sqrt{3})} = \frac{3\sqrt{3} + \sqrt{3}^2 + 9 + 3\sqrt{3}}{3^2 - \sqrt{3}^2} \\ &= \frac{3 + 9 + 6\sqrt{3}}{9 - 3} = \frac{12 + 6\sqrt{3}}{6} = 2 + \sqrt{3} \end{aligned}$$

c) Again we need to write the angle $\frac{11\pi}{12}$ as a sum or difference of the above angles. In fact, we can do so in at least two different ways: $\frac{11\pi}{12} = \frac{6\pi}{12} + \frac{5\pi}{12}$ and also $\frac{11\pi}{12} = \frac{12\pi}{12} - \frac{\pi}{12} = \pi - \frac{\pi}{12}$. In either case, we first need to calculate some other trigonometric functions, namely those for either $\frac{5\pi}{12}$ or $\frac{\pi}{12}$. We choose the second solution, and using part (a), we have

$$\cos\left(\frac{\pi}{12}\right) = \frac{\sqrt{2} + \sqrt{6}}{4}, \text{ and,}$$

$$\begin{aligned}\sin\left(\frac{\pi}{12}\right) &= \sin\left(\frac{\pi}{3} - \frac{\pi}{4}\right) = \sin\frac{\pi}{3}\cos\frac{\pi}{4} - \cos\frac{\pi}{3}\sin\frac{\pi}{4} \\ &= \frac{\sqrt{3}}{2} \cdot \frac{\sqrt{2}}{2} - \frac{1}{2} \cdot \frac{\sqrt{2}}{2} = \frac{\sqrt{6}}{4} - \frac{\sqrt{2}}{4} = \frac{\sqrt{6} - \sqrt{2}}{4}\end{aligned}$$

With this, we have

$$\begin{aligned}\cos\left(\frac{11\pi}{12}\right) &= \cos\left(\pi - \frac{\pi}{12}\right) = \cos\pi\cos\frac{\pi}{12} + \sin\pi\sin\frac{\pi}{12} \\ &= (-1) \cdot \frac{\sqrt{2} + \sqrt{6}}{4} + 0 \cdot \frac{\sqrt{6} - \sqrt{2}}{4} = \frac{-(\sqrt{2} + \sqrt{6})}{4}\end{aligned}$$

□

Generalizing the previous example, we can obtain any multiple of $\frac{\pi}{12}$ as a sum or difference of known angles coming from the $30^\circ - 60^\circ - 90^\circ$ and $45^\circ - 45^\circ - 90^\circ$ triangles:

Note 18.3. Starting from the angles $\frac{\pi}{6} = \frac{2\pi}{12}$, $\frac{\pi}{4} = \frac{3\pi}{12}$, $\frac{\pi}{3} = \frac{4\pi}{12}$, and $\frac{\pi}{2} = \frac{6\pi}{12}$, we obtain multiples of the angle $\frac{\pi}{12}$ by addition and subtraction, such as:

$$\begin{aligned}\frac{\pi}{12} &= \frac{4\pi}{12} - \frac{3\pi}{12}, & \frac{5\pi}{12} &= \frac{2\pi}{12} + \frac{3\pi}{12}, & \frac{7\pi}{12} &= \frac{4\pi}{12} + \frac{3\pi}{12}, \\ \frac{8\pi}{12} &= \frac{4\pi}{12} + \frac{4\pi}{12}, & \frac{9\pi}{12} &= \frac{6\pi}{12} + \frac{3\pi}{12}, & \frac{10\pi}{12} &= \frac{6\pi}{12} + \frac{4\pi}{12}, \\ \text{and } \frac{11\pi}{12} &= \frac{6\pi}{12} + \frac{5\pi}{12} = \frac{12\pi}{12} - \frac{\pi}{12}.\end{aligned}$$

Here, the trigonometric function values of the last fraction is obtained from the previously obtained trigonometric values, as in part (c) of example 18.2. Higher multiples of $\frac{\pi}{12}$ can be obtained from the above list by adding multiples of π to it. Note also that in many instances there are several ways of writing an angle as a sum or difference. For example: $\frac{8\pi}{12} = \frac{4\pi}{12} + \frac{4\pi}{12} = \frac{6\pi}{12} + \frac{2\pi}{12} = \frac{12\pi}{12} - \frac{4\pi}{12}$

Using proposition 18.1 we can prove other related trigonometric identities with the addition and subtraction formulas.

Example 18.4. We rewrite $\cos\left(x + \frac{\pi}{2}\right)$ by using the subtraction formula.

$$\cos\left(x + \frac{\pi}{2}\right) = \cos x \cdot \cos\frac{\pi}{2} - \sin x \cdot \sin\frac{\pi}{2} = \cos x \cdot 0 + \sin x \cdot 1 = \sin(x)$$

18.2 Double and half angles

We can write formulas for the trigonometric functions of twice an angle and half an angle.

Proposition 18.5. Let α be an angle. Then we have the half-angle formulas:

$$\begin{aligned}\sin \frac{\alpha}{2} &= \pm \sqrt{\frac{1 - \cos \alpha}{2}} \\ \cos \frac{\alpha}{2} &= \pm \sqrt{\frac{1 + \cos \alpha}{2}} \\ \tan \frac{\alpha}{2} &= \frac{1 - \cos \alpha}{\sin \alpha} = \frac{\sin \alpha}{1 + \cos \alpha} = \pm \sqrt{\frac{1 - \cos \alpha}{1 + \cos \alpha}}\end{aligned}$$

Here, the signs “ \pm ” are determined by the quadrant in which the angle $\frac{\alpha}{2}$ lies. (For more on the signs, see also page 234.)

Furthermore, we have the double angle formulas:

$$\begin{aligned}\sin(2\alpha) &= 2 \sin \alpha \cos \alpha \\ \cos(2\alpha) &= \cos^2 \alpha - \sin^2 \alpha = 1 - 2 \sin^2 \alpha = 2 \cos^2 \alpha - 1 \\ \tan(2\alpha) &= \frac{2 \tan \alpha}{1 - \tan^2 \alpha}\end{aligned}$$

Proof. We start with the double angle formulas, which we prove using Proposition 18.1.

$$\begin{aligned}\sin(2\alpha) &= \sin(\alpha + \alpha) = \sin \alpha \cos \alpha + \cos \alpha \sin \alpha = 2 \sin \alpha \cos \alpha \\ \cos(2\alpha) &= \cos(\alpha + \alpha) = \cos \alpha \cos \alpha - \sin \alpha \sin \alpha = \cos^2 \alpha - \sin^2 \alpha \\ \tan(2\alpha) &= \tan(\alpha + \alpha) = \frac{\tan \alpha + \tan \alpha}{1 - \tan \alpha \tan \alpha} = \frac{2 \tan \alpha}{1 - \tan^2 \alpha}\end{aligned}$$

Notice that $\cos(2\alpha) = \cos^2 \alpha - \sin^2 \alpha$ can be rewritten using $\sin^2 \alpha + \cos^2 \alpha = 1$ as follows:

$$\begin{aligned}\cos^2 \alpha - \sin^2 \alpha &= (1 - \sin^2 \alpha) - \sin^2 \alpha = 1 - 2 \sin^2 \alpha \\ \text{and } \cos^2 \alpha - \sin^2 \alpha &= \cos^2 \alpha - (1 - \cos^2 \alpha) = 2 \cos^2 \alpha - 1\end{aligned}$$

This shows the double angle formulas. These formulas can now be used to prove the half-angle formulas.

$$\begin{aligned}\cos(2\alpha) &= 1 - 2 \sin^2 \alpha \implies 2 \sin^2 \alpha = 1 - \cos(2\alpha) \implies \sin^2 \alpha = \frac{1 - \cos(2\alpha)}{2} \\ &\implies \sin \alpha = \pm \sqrt{\frac{1 - \cos(2\alpha)}{2}} \xrightarrow{\text{replace } \alpha \text{ by } \frac{\alpha}{2}} \sin \frac{\alpha}{2} = \pm \sqrt{\frac{1 - \cos \alpha}{2}} \\ \cos(2\alpha) &= 2 \cos^2 \alpha - 1 \implies 2 \cos^2 \alpha = 1 + \cos(2\alpha) \implies \cos^2 \alpha = \frac{1 + \cos(2\alpha)}{2} \\ &\implies \cos \alpha = \pm \sqrt{\frac{1 + \cos(2\alpha)}{2}} \xrightarrow{\text{replace } \alpha \text{ by } \frac{\alpha}{2}} \cos \frac{\alpha}{2} = \pm \sqrt{\frac{1 + \cos \alpha}{2}} \\ \text{in particular: } \tan \frac{\alpha}{2} &= \frac{\sin(\frac{\alpha}{2})}{\cos(\frac{\alpha}{2})} = \frac{\pm \sqrt{\frac{1 - \cos \alpha}{2}}}{\pm \sqrt{\frac{1 + \cos \alpha}{2}}} = \pm \sqrt{\frac{1 - \cos \alpha}{1 + \cos \alpha}}\end{aligned}$$

258 SESSION 18. ADDITION OF ANGLES AND MULTIPLE ANGLES

For the first two formulas for $\tan \frac{\alpha}{2}$ we simplify $\sin(2\alpha) \cdot \tan(\alpha)$ and $(1 + \cos(2\alpha)) \cdot \tan(\alpha)$ as follows.

$$\begin{aligned} \sin(2\alpha) \cdot \tan(\alpha) &= 2 \sin \alpha \cos \alpha \cdot \frac{\sin \alpha}{\cos \alpha} = 2 \sin^2 \alpha = 1 - \cos(2\alpha) \\ &\implies \tan(\alpha) = \frac{1 - \cos(2\alpha)}{\sin(2\alpha)} \xrightarrow{\text{replace } \alpha \text{ by } \frac{\alpha}{2}} \tan\left(\frac{\alpha}{2}\right) = \frac{1 - \cos(\alpha)}{\sin(\alpha)} \\ (1 + \cos(2\alpha)) \cdot \tan(\alpha) &= 2 \cos^2 \alpha \cdot \frac{\sin \alpha}{\cos \alpha} = 2 \sin \alpha \cos \alpha = \sin(2\alpha) \\ &\implies \tan(\alpha) = \frac{\sin(2\alpha)}{1 + \cos(2\alpha)} \xrightarrow{\text{replace } \alpha \text{ by } \frac{\alpha}{2}} \tan\left(\frac{\alpha}{2}\right) = \frac{\sin(\alpha)}{1 + \cos(\alpha)} \end{aligned}$$

This completes the proof of the proposition. \square

Here is an example involving the half-angle identities.

Example 18.6. Find the trigonometric functions using the half-angle formulas.

a) $\sin\left(\frac{\pi}{8}\right)$ b) $\cos\left(\frac{9\pi}{8}\right)$ c) $\tan\left(\frac{\pi}{24}\right)$

Solution. a) Since $\frac{\pi}{8} = \frac{\frac{\pi}{4}}{2}$, we use the half-angle formula with $\alpha = \frac{\pi}{4}$.

$$\begin{aligned} \sin\left(\frac{\pi}{8}\right) &= \sin\left(\frac{\frac{\pi}{4}}{2}\right) = \pm \sqrt{\frac{1 - \cos \frac{\pi}{4}}{2}} = \pm \sqrt{\frac{1 - \frac{\sqrt{2}}{2}}{2}} = \pm \sqrt{\frac{2 - \sqrt{2}}{2}} \\ &= \pm \sqrt{\frac{2 - \sqrt{2}}{4}} = \pm \frac{\sqrt{2 - \sqrt{2}}}{2}. \end{aligned}$$

Since $\frac{\pi}{8} = \frac{180^\circ}{8} = 22.5^\circ$ is in the first quadrant, the sine is positive, so that $\sin\left(\frac{\pi}{8}\right) = \frac{\sqrt{2 - \sqrt{2}}}{2}$.

b) Note that $\frac{9\pi}{8} = \frac{9\pi}{4}$. So we use $\alpha = \frac{9\pi}{4}$. Now, $\frac{9\pi}{8} = \frac{9 \cdot 180^\circ}{8} = 202.5^\circ$ is in the third quadrant, so that the cosine is negative. We have:

$$\cos\left(\frac{9\pi}{8}\right) = \cos\left(\frac{\frac{9\pi}{4}}{2}\right) = -\sqrt{\frac{1 + \cos \frac{9\pi}{4}}{2}}.$$

Now, $\cos\left(\frac{9\pi}{4}\right) = \cos\left(\frac{8\pi + \pi}{4}\right) = \cos\left(2\pi + \frac{\pi}{4}\right) = \cos\left(\frac{\pi}{4}\right) = \frac{\sqrt{2}}{2}$, so that

$$\cos\left(\frac{9\pi}{8}\right) = -\sqrt{\frac{1 + \frac{\sqrt{2}}{2}}{2}} = -\sqrt{\frac{2 + \sqrt{2}}{2}} = -\sqrt{\frac{2 + \sqrt{2}}{4}} = -\frac{\sqrt{2 + \sqrt{2}}}{2}.$$

c) Note that $\frac{\pi}{24} = \frac{\frac{\pi}{12}}{2}$, and we already calculated the trigonometric function values of $\alpha = \frac{\pi}{12}$ in example 18.2(c). So that we obtain:

$$\begin{aligned}\tan\left(\frac{\pi}{24}\right) &= \tan\left(\frac{\frac{\pi}{12}}{2}\right) = \frac{1 - \cos \frac{\pi}{12}}{\sin \frac{\pi}{12}} = \frac{1 - \frac{\sqrt{2} + \sqrt{6}}{4}}{\frac{\sqrt{6} - \sqrt{2}}{4}} = \frac{\frac{4 - \sqrt{2} - \sqrt{6}}{4}}{\frac{\sqrt{6} - \sqrt{2}}{4}} \\ &= \frac{4 - \sqrt{2} - \sqrt{6}}{4} \cdot \frac{4}{\sqrt{6} - \sqrt{2}} = \frac{4 - \sqrt{2} - \sqrt{6}}{\sqrt{6} - \sqrt{2}}\end{aligned}$$

We can rationalize the denominator by multiplying numerator and denominator by $(\sqrt{6} + \sqrt{2})$.

$$\begin{aligned}\tan\left(\frac{\pi}{24}\right) &= \frac{4 - \sqrt{2} - \sqrt{6}}{\sqrt{6} - \sqrt{2}} \cdot \frac{\sqrt{6} + \sqrt{2}}{\sqrt{6} + \sqrt{2}} \\ &= \frac{4\sqrt{6} + 4\sqrt{2} - \sqrt{12} - \sqrt{4} - \sqrt{36} - \sqrt{12}}{6 - 2} = \frac{4\sqrt{6} + 4\sqrt{2} - 2\sqrt{12} - 2 - 6}{4} \\ &= \frac{4\sqrt{6} + 4\sqrt{2} - 4\sqrt{3} - 8}{4} = \sqrt{6} + \sqrt{2} - \sqrt{3} - 2.\end{aligned}$$

Although we used the first formula for $\tan \frac{\alpha}{2}$ from the proposition, we could as well have used the other two formulas. \square

Example 18.7. Find the trigonometric functions of 2α when α has the properties below.

- a) $\sin(\alpha) = \frac{3}{5}$, and α is in quadrant II
- b) $\tan(\alpha) = \frac{12}{5}$, and α is in quadrant III

Solution. a) From $\sin^2(\alpha) + \cos^2(\alpha) = 1$, we find that $\cos^2(\alpha) = 1 - \sin^2(\alpha)$, and since α is in the second quadrant, $\cos(\alpha)$ is negative, so that

$$\begin{aligned}\cos(\alpha) &= -\sqrt{1 - \sin^2(\alpha)} = -\sqrt{1 - \left(\frac{3}{5}\right)^2} = -\sqrt{1 - \frac{9}{25}} \\ &= -\sqrt{\frac{25 - 9}{25}} = -\sqrt{\frac{16}{25}} = -\frac{4}{5},\end{aligned}$$

and

$$\tan(\alpha) = \frac{\sin \alpha}{\cos \alpha} = \frac{\frac{3}{5}}{-\frac{4}{5}} = \frac{3}{5} \cdot \frac{5}{-4} = -\frac{3}{4}$$

From this we can calculate the solution by plugging these values into the double angle formulas.

$$\sin(2\alpha) = 2 \sin \alpha \cos \alpha = 2 \cdot \frac{3}{5} \cdot \frac{(-4)}{5} = \frac{-24}{25}$$

$$\cos(2\alpha) = \cos^2(\alpha) - \sin^2(\alpha) = \left(\frac{-4}{5}\right)^2 - \left(\frac{3}{5}\right)^2 = \frac{16}{25} - \frac{9}{25} = \frac{7}{25}$$

$$\tan(2\alpha) = \frac{2 \tan \alpha}{1 - \tan^2 \alpha} = \frac{2 \cdot \left(\frac{-3}{4}\right)}{1 - \left(\frac{-3}{4}\right)^2} = \frac{\frac{-3}{2}}{1 - \frac{9}{16}} = \frac{\frac{-3}{2}}{\frac{16-9}{16}} = \frac{-3}{2} \cdot \frac{16}{7} = \frac{-24}{7}$$

b) Similar to the calculation in part (a), we first calculate $\sin(\alpha)$ and $\cos(\alpha)$, which are both negative in the third quadrant. Recall from equation (17.2) on page 234 that $\sec^2 \alpha = 1 + \tan^2 \alpha$, where $\sec \alpha = \frac{1}{\cos \alpha}$. Therefore,

$$\sec^2 \alpha = 1 + \left(\frac{12}{5}\right)^2 = 1 + \frac{144}{25} = \frac{25 + 144}{25} = \frac{169}{25} \implies \sec \alpha = \pm \frac{13}{5}$$

Since $\cos(\alpha)$ is negative (in quadrant III), so is $\sec(\alpha)$, so that we get,

$$\cos \alpha = \frac{1}{\sec \alpha} = \frac{1}{-\frac{13}{5}} = -\frac{5}{13}$$

Furthermore, $\sin^2 \alpha = 1 - \cos^2 \alpha$, and $\sin \alpha$ is negative (in quadrant III), we have

$$\begin{aligned} \sin \alpha &= -\sqrt{1 - \cos^2 \alpha} = -\sqrt{1 - \left(-\frac{5}{13}\right)^2} = -\sqrt{1 - \frac{25}{169}} \\ &= -\sqrt{\frac{169 - 25}{169}} = -\sqrt{\frac{144}{169}} = -\frac{12}{13} \end{aligned}$$

Thus, we obtain the solution as follows:

$$\sin(2\alpha) = 2 \sin \alpha \cos \alpha = 2 \cdot \frac{(-12)}{13} \cdot \frac{(-5)}{13} = \frac{120}{169}$$

$$\cos(2\alpha) = \cos^2(\alpha) - \sin^2(\alpha) = \left(\frac{-5}{13}\right)^2 - \left(\frac{-12}{13}\right)^2 = \frac{25}{169} - \frac{144}{169} = \frac{-119}{169}$$

$$\begin{aligned} \tan(2\alpha) &= \frac{2 \tan \alpha}{1 - \tan^2 \alpha} = \frac{2 \cdot \frac{12}{5}}{1 - \left(\frac{12}{5}\right)^2} = \frac{\frac{24}{5}}{1 - \frac{144}{25}} = \frac{\frac{24}{5}}{\frac{25-144}{25}} \\ &= \frac{24}{5} \cdot \frac{25}{-119} = \frac{120}{-119} \end{aligned}$$

□

18.3 Exercises

Exercise 18.1. Find the trigonometric function values.

$$\begin{array}{llll} \text{a) } \sin\left(\frac{5\pi}{12}\right) & \text{b) } \cos\left(\frac{5\pi}{12}\right) & \text{c) } \tan\left(\frac{\pi}{12}\right) & \text{d) } \sin\left(\frac{7\pi}{12}\right) \\ \text{e) } \cos\left(\frac{11\pi}{12}\right) & \text{f) } \sin\left(\frac{2\pi}{3}\right) & \text{g) } \sin\left(\frac{5\pi}{6}\right) & \text{h) } \cos\left(\frac{3\pi}{4}\right) \\ \text{i) } \tan\left(\frac{13\pi}{12}\right) & \text{j) } \cos\left(-\frac{\pi}{12}\right) & \text{k) } \sin\left(\frac{11\pi}{12}\right) & \text{l) } \sin\left(\frac{29\pi}{12}\right) \end{array}$$

Exercise 18.2. Simplify the function f using the addition and subtraction formulas.

$$\begin{array}{lll} \text{a) } f(x) = \sin\left(x + \frac{\pi}{2}\right) & \text{b) } f(x) = \cos\left(x - \frac{\pi}{4}\right) & \text{c) } f(x) = \tan(\pi - x) \\ \text{d) } f(x) = \sin\left(\frac{\pi}{6} - x\right) & \text{e) } f(x) = \cos\left(x + \frac{11\pi}{12}\right) & \text{f) } f(x) = \cos\left(\frac{2\pi}{3} - x\right) \end{array}$$

Exercise 18.3. Find the exact values of the trigonometric functions applied to the given angles by using the half-angle formulas.

$$\begin{array}{llll} \text{a) } \cos\left(\frac{\pi}{12}\right) & \text{b) } \tan\left(\frac{\pi}{8}\right) & \text{c) } \sin\left(\frac{\pi}{24}\right) & \text{d) } \cos\left(\frac{\pi}{24}\right) \\ \text{e) } \sin\left(\frac{9\pi}{8}\right) & \text{f) } \tan\left(\frac{3\pi}{8}\right) & \text{g) } \sin\left(\frac{-\pi}{8}\right) & \text{h) } \sin\left(\frac{13\pi}{24}\right) \end{array}$$

Exercise 18.4. Find the exact values of the trigonometric functions of $\frac{\alpha}{2}$ and of 2α by using the half-angle and double angle formulas.

$$\begin{array}{l} \text{a) } \sin(\alpha) = \frac{4}{5}, \text{ and } \alpha \text{ in quadrant I} \\ \text{b) } \cos(\alpha) = \frac{7}{13}, \text{ and } \alpha \text{ in quadrant IV} \\ \text{c) } \sin(\alpha) = \frac{-3}{5}, \text{ and } \alpha \text{ in quadrant III} \\ \text{d) } \tan(\alpha) = \frac{4}{3}, \text{ and } \alpha \text{ in quadrant III} \\ \text{e) } \tan(\alpha) = \frac{-5}{12}, \text{ and } \alpha \text{ in quadrant II} \\ \text{f) } \cos(\alpha) = \frac{-2}{3}, \text{ and } \alpha \text{ in quadrant II} \end{array}$$

Session 19

Inverse trigonometric functions

19.1 The functions \sin^{-1} , \cos^{-1} , and \tan^{-1}

The inverse trigonometric functions are the inverse functions of the $y = \sin x$, $y = \cos x$, and $y = \tan x$ functions restricted to appropriate domains. In this section we give a precise definition of these functions.

The function $y = \tan^{-1}(x)$

We start with the inverse to the tangent function $y = \tan(x)$. Recall that the graph of $y = \tan(x)$ is the following:

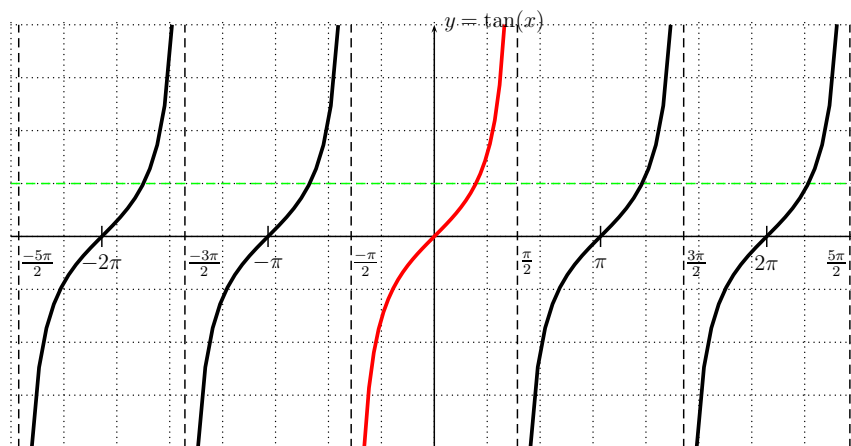

It has vertical asymptotes at $x = \pm\frac{\pi}{2}, \pm\frac{3\pi}{2}, \pm\frac{5\pi}{2}, \dots$. Note, that $y = \tan(x)$ is not a one-to-one function in the sense of definition 7.1 on page 86. (For

example, the horizontal line $y = 1$ intersects the graph at $x = \frac{\pi}{4}$, $x = \frac{\pi}{4} \pm \pi$, $x = \frac{\pi}{4} \pm 2\pi$, etc.) However, when we restrict the function to the domain $D = (-\frac{\pi}{2}, \frac{\pi}{2})$ the restricted function is one-to-one, and, for this restricted function, we may take its inverse function.

Definition 19.1. The inverse of the function $y = \tan(x)$ with restricted domain $D = (-\frac{\pi}{2}, \frac{\pi}{2})$ and range $R = \mathbb{R}$ is called the **inverse tangent** or **arctangent** function. It is denoted by

$$y = \tan^{-1}(x) \quad \text{or} \quad y = \arctan(x) \quad \iff \quad \tan(y) = x, \quad y \in \left(-\frac{\pi}{2}, \frac{\pi}{2}\right)$$

The arctangent reverses the input and output of the tangent function, so that the arctangent has domain $D = \mathbb{R}$ and range $R = (-\frac{\pi}{2}, \frac{\pi}{2})$. The graph is displayed below.

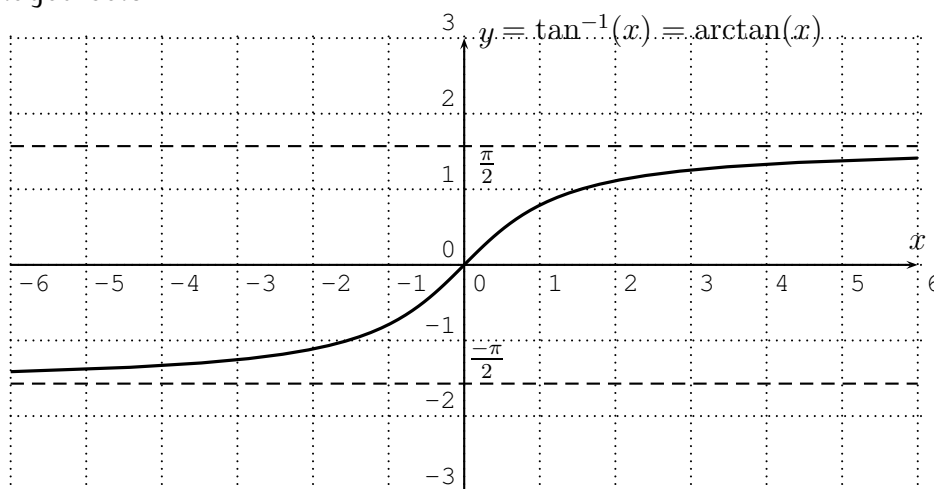

Warning 19.2. The notation of $\tan^{-1}(x)$ and $\tan^2(x)$ is slightly inconsistent, since the exponentiation symbol is used above in two different ways. In fact, $\tan^{-1}(x) = \arctan(x)$ refers to the *inverse function* of the $\tan(x)$ function. However, when we write $\tan^2(x)$, we mean

$$\tan^2(x) = (\tan(x))^2 = \tan(x) \cdot \tan(x)$$

Therefore, $\tan^{-1}(x)$ is the inverse function of $\tan(x)$ with respect to the *composition* operation, whereas $\tan^2(x)$ is the square with respect to the *usual product* in \mathbb{R} . Note also that the inverse function of the tangent with respect to the product in \mathbb{R} is $y = \frac{1}{\tan(x)} = \cot(x)$, which is the cotangent.

Observation 19.3. The inverse tangent function is an odd function:

$$\boxed{\tan^{-1}(-x) = -\tan^{-1}(x)} \quad (19.1)$$

This can be seen by observing that the tangent $y = \tan(x)$ is an odd function (that is $\tan(-x) = -\tan(x)$), or directly from the symmetry of the graph with respect to the origin $(0, 0)$.

The next example calculates function values of the inverse tangent function.

Example 19.4. Recall the exact values of the tangent function from section 17.1:

x	$0 = 0^\circ$	$\frac{\pi}{6} = 30^\circ$	$\frac{\pi}{4} = 45^\circ$	$\frac{\pi}{3} = 60^\circ$	$\frac{\pi}{2} = 90^\circ$
$\tan(x)$	0	$\frac{\sqrt{3}}{3}$	1	$\sqrt{3}$	undef.

From this, we can deduce function values by reversing inputs and outputs, such as:

$$\begin{aligned}\tan\left(\frac{\pi}{6}\right) = \frac{\sqrt{3}}{3} &\implies \tan^{-1}\left(\frac{\sqrt{3}}{3}\right) = \frac{\pi}{6} \\ \tan\left(\frac{\pi}{4}\right) = 1 &\implies \tan^{-1}(1) = \frac{\pi}{4}\end{aligned}$$

Also, since $\tan^{-1}(-x) = -\tan^{-1}(x)$, we obtain the inverse tangent of negative numbers.

$$\begin{aligned}\tan^{-1}(-\sqrt{3}) &= -\tan^{-1}(\sqrt{3}) = -\frac{\pi}{3} \\ \tan^{-1}(-1) &= -\tan^{-1}(1) = -\frac{\pi}{4}\end{aligned}$$

We may calculate the inverse tangent of specific values with the calculator using the **2nd** and **tan** keys. For example, $\tan^{-1}(4.3) \approx 1.34$.

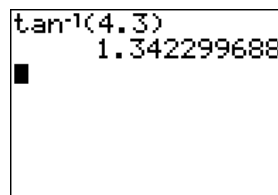

Note, that the answer differs, when changing the mode from radians to degree, since $\tan^{-1}(4.3) \approx 76.9^\circ \approx 1.34$.

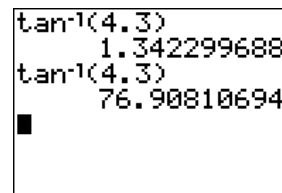
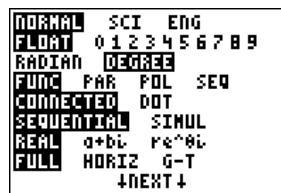

The function $y = \sin^{-1}(x)$

Next, we define the inverse sine function. For this, we again first recall the graph of the $y = \sin(x)$ function, and note that it is also *not* one-to-one.

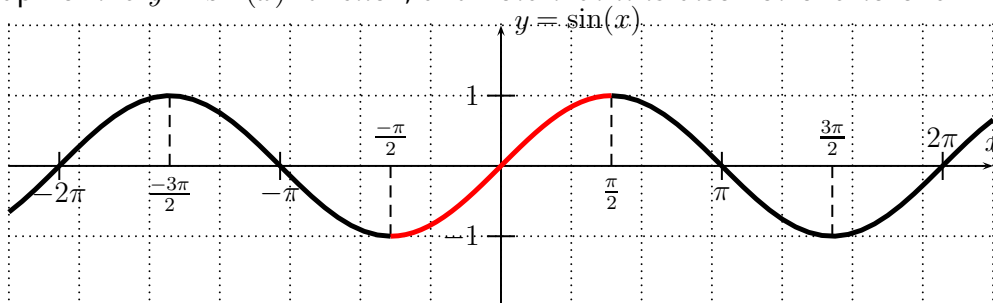

However, when restricting the sine to the domain $[-\frac{\pi}{2}, \frac{\pi}{2}]$, the restricted function *is* one-to-one. Note furthermore, that when restricting the domain to $[-\frac{\pi}{2}, \frac{\pi}{2}]$, the range is $[-1, 1]$, and therefore we cannot extend this to a larger domain in a way such that the function remains a one-to-one function. We use the domain $[-\frac{\pi}{2}, \frac{\pi}{2}]$ to define the inverse sine function.

Definition 19.5. The inverse of the function $y = \sin(x)$ with restricted domain $D = [-\frac{\pi}{2}, \frac{\pi}{2}]$ and range $R = [-1, 1]$ is called the **inverse sine** or **arcsine** function. It is denoted by

$$y = \sin^{-1}(x) \quad \text{or} \quad y = \arcsin(x) \quad \iff \quad \sin(y) = x, \quad y \in \left[-\frac{\pi}{2}, \frac{\pi}{2}\right]$$

The arcsine reverses the input and output of the sine function, so that the arcsine has domain $D = [-1, 1]$ and range $R = [-\frac{\pi}{2}, \frac{\pi}{2}]$. The graph of the arcsine is drawn below.

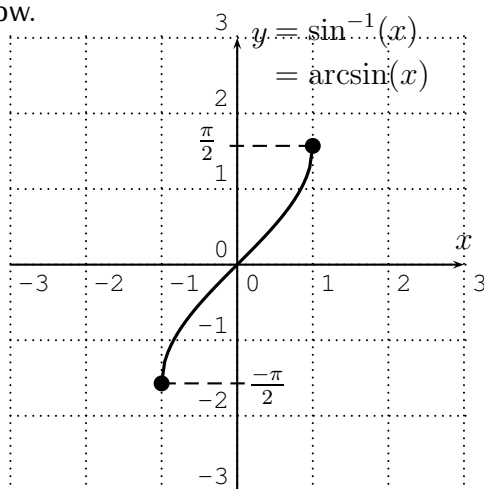

Observation 19.6. The inverse sine function is odd:

$$\boxed{\sin^{-1}(-x) = -\sin^{-1}(x)} \quad (19.2)$$

This can again be seen by observing that the sine $y = \sin(x)$ is an odd function (that is $\sin(-x) = -\sin(x)$), or alternatively directly from the symmetry of the graph with respect to the origin $(0, 0)$.

We now calculate specific function values of the inverse sine.

Example 19.7. We first recall the known values of the sine.

x	$0 = 0^\circ$	$\frac{\pi}{6} = 30^\circ$	$\frac{\pi}{4} = 45^\circ$	$\frac{\pi}{3} = 60^\circ$	$\frac{\pi}{2} = 90^\circ$
$\sin(x)$	0	$\frac{1}{2}$	$\frac{\sqrt{2}}{2}$	$\frac{\sqrt{3}}{2}$	1

These values together with the fact that the inverse sine is odd, that is $\sin^{-1}(-x) = -\sin^{-1}(x)$, provides us with examples of its function values.

$$\begin{aligned} \sin^{-1}\left(\frac{\sqrt{2}}{2}\right) &= \frac{\pi}{4}, & \sin^{-1}(1) &= \frac{\pi}{2}, \\ \sin^{-1}(0) &= 0, & \sin^{-1}\left(\frac{-1}{2}\right) &= -\sin^{-1}\left(\frac{1}{2}\right) = -\frac{\pi}{6}. \end{aligned}$$

Note, that the domain of $y = \sin^{-1}(x)$ is $D = [-1, 1]$, so that input numbers that are not in this interval give undefined outputs of the inverse sine:

$$\sin^{-1}(3) \text{ is undefined}$$

Input values that are not in the above table may be found with the calculator via the keys. We point out, that the output values depend on whether the calculator is set to radian or degree mode. (Recall that the mode may be changed via the key).

```
NORMAL SCI ENG
FLOAT 0123456789
RADIAN DEGREE
FUNC PAR POL SEQ
CONNECTED DOT
SEQUENTIAL SIMUL
REAL a+b% P%*%
FULL HORIZ G-T
↓NEXT↓
```

```
sin-1(0.91)
1.143284062
sin-1(√3/2)
1.047197551
sin-1(-1)
-1.570796327
```

```
NORMAL SCI ENG
FLOAT 0123456789
RADIAN DEGREE
FUNC PAR POL SEQ
CONNECTED DOT
SEQUENTIAL SIMUL
REAL a+b% P%*%
FULL HORIZ G-T
↓NEXT↓
```

```
sin-1(0.91)
65.50535153
sin-1(√3/2)
60
sin-1(-1)
-90
```

The function $y = \cos^{-1}(x)$

Finally, we define the inverse cosine. Recall the graph of $y = \cos(x)$, and note again that the function is *not* one-to-one.

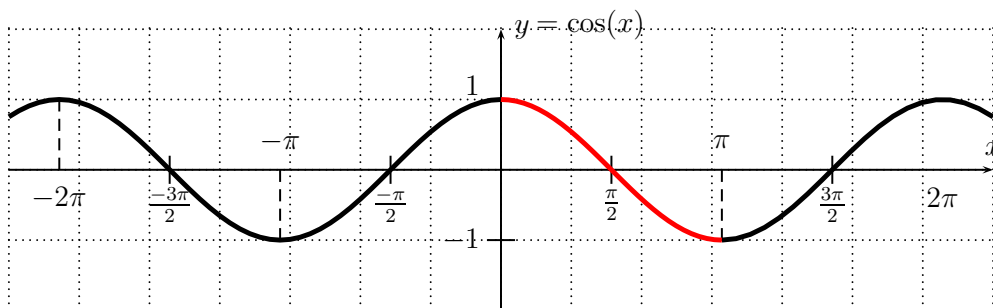

In this case, the way to restrict the cosine to a one-to-one function is not as clear as in the previous cases for the sine and tangent. By convention, the cosine is restricted to the domain $[0, \pi]$. This provides a function that is one-to-one, which is used to define the inverse cosine.

Definition 19.8. The inverse of the function $y = \cos(x)$ with restricted domain $D = [0, \pi]$ and range $R = [-1, 1]$ is called the **inverse cosine** or **arccosine** function. It is denoted by

$$y = \cos^{-1}(x) \quad \text{or} \quad y = \arccos(x) \quad \iff \quad \cos(y) = x, \quad y \in [0, \pi]$$

The arccosine reverses the input and output of the cosine function, so that the arccosine has domain $D = [-1, 1]$ and range $R = [0, \pi]$. The graph of the arccosine is drawn below.

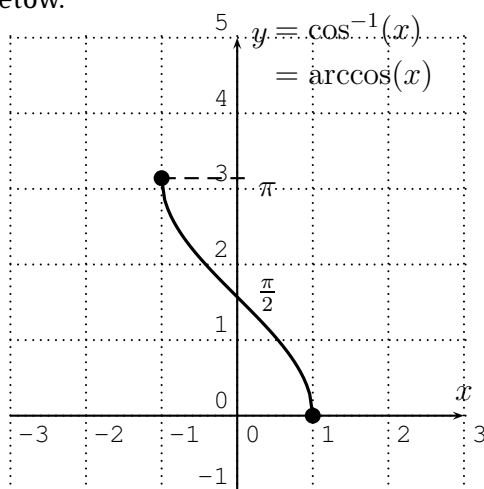

Observation 19.9. The inverse cosine function is *neither even nor odd*. That is, the function $\cos^{-1}(-x)$ *cannot* be computed by simply taking $\pm \cos^{-1}(x)$. But it does have some symmetry given algebraically by the more complicated relation

$$\boxed{\cos^{-1}(-x) = \pi - \cos^{-1}(x)} \quad (19.3)$$

Proof. We can see that if we shift the graph down by $\frac{\pi}{2}$ the resulting function is odd. That is to say the function with the rule $\cos^{-1}(x) - \frac{\pi}{2}$ is odd:

$$\cos^{-1}(-x) - \frac{\pi}{2} = -(\cos^{-1}(x) - \frac{\pi}{2}),$$

which yields 19.3 upon distributing and adding $\frac{\pi}{2}$.

Another, more formal approach is as follows. The bottom right relation of (17.3) on page 234 states, that we have the relation $\cos(\pi - y) = -\cos(y)$ for all y . Let $-1 \leq x \leq 1$, and denote by $y = \cos^{-1}(x)$. That is y is the number $0 \leq y \leq \pi$ with $\cos(y) = x$. Then we have

$$-x = -\cos(y) = \cos(\pi - y) \quad (\text{by equation (17.3)})$$

Applying \cos^{-1} to both sides gives:

$$\cos^{-1}(-x) = \cos^{-1}(\cos(\pi - y)) = \pi - y$$

The last equality follows, since \cos and \cos^{-1} are inverse to each other, and $0 \leq y \leq \pi$, so that $0 \leq \pi - y \leq \pi$ are also in the range of the \cos^{-1} . Rewriting $y = \cos^{-1}(x)$ gives the wanted result:

$$\cos^{-1}(-x) = \pi - \cos^{-1}(x)$$

This is the equation (19.3) which we wanted to prove. □

We now calculate specific function values of the inverse cosine.

Example 19.10. We first recall the known values of the cosine.

x	$0 = 0^\circ$	$\frac{\pi}{6} = 30^\circ$	$\frac{\pi}{4} = 45^\circ$	$\frac{\pi}{3} = 60^\circ$	$\frac{\pi}{2} = 90^\circ$
$\cos(x)$	1	$\frac{\sqrt{3}}{2}$	$\frac{\sqrt{2}}{2}$	$\frac{1}{2}$	0

Here are some examples for function values of the inverse cosine.

$$\cos^{-1}\left(\frac{\sqrt{3}}{2}\right) = \frac{\pi}{6}, \quad \cos^{-1}(1) = 0, \quad \cos^{-1}(0) = \frac{\pi}{2}.$$

Negative inputs to the arccosine can be calculated with equation (19.3), that is $\cos^{-1}(-x) = \pi - \cos^{-1}(x)$, or by going back to the unit circle definition.

$$\cos^{-1}\left(-\frac{1}{2}\right) = \pi - \cos^{-1}\left(\frac{1}{2}\right) = \pi - \frac{\pi}{3} = \frac{3\pi - \pi}{3} = \frac{2\pi}{3},$$

$$\cos^{-1}(-1) = \pi - \cos^{-1}(1) = \pi - 0 = \pi.$$

Furthermore, the domain of $y = \cos^{-1}(x)$ is $D = [-1, 1]$, so that input numbers not in this interval give undefined outputs of the inverse cosine.

$\cos^{-1}(17)$ is undefined

Other input values can be obtained with the calculator by pressing the `2nd` `cos` keys. For example, we obtain the following function values (here using radian measure).

```
cos-1(0.654)
.8579363495
cos-1(1)
0
cos-1(-1)
3.141592654
■
```

```
cos-1(0)
1.570796327
cos-1(2)
Error
cos-1(-0.1)
1.670963748
■
```

19.2 Exercises

Exercise 19.1. Graph the function with the calculator. Use both radian and degree mode to display your graph. Zoom to an appropriate window for each mode to display a graph which includes the main features of the graph.

a) $y = \sin^{-1}(x)$ b) $y = \cos^{-1}(x)$ c) $y = \tan^{-1}(x)$

Exercise 19.2. Find the exact value of the inverse trigonometric function.

a) $\tan^{-1}(\sqrt{3})$ b) $\sin^{-1}(\frac{1}{2})$ c) $\cos^{-1}(\frac{1}{2})$ d) $\tan^{-1}(0)$
 e) $\cos^{-1}(\frac{\sqrt{2}}{2})$ f) $\cos^{-1}(-\frac{\sqrt{2}}{2})$ g) $\sin^{-1}(-1)$ h) $\tan^{-1}(-\sqrt{3})$
 i) $\cos^{-1}(-\frac{\sqrt{3}}{2})$ j) $\sin^{-1}(-\frac{\sqrt{2}}{2})$ k) $\sin^{-1}(-\frac{\sqrt{3}}{2})$ l) $\tan^{-1}(-\frac{1}{\sqrt{3}})$

Exercise 19.3. Find the inverse trigonometric function value using the calculator. Approximate your answer to the nearest hundredth.

- For parts (a)-(f), write your answer in radian mode.

a) $\cos^{-1}(0.2)$ b) $\sin^{-1}(-0.75)$ c) $\cos^{-1}(\frac{1}{3})$
 d) $\tan^{-1}(100,000)$ e) $\tan^{-1}(-2)$ f) $\cos^{-1}(-2)$

- For parts (g)-(l), write your answer in degree mode.

g) $\cos^{-1}(0.68)$ h) $\tan^{-1}(-1)$ i) $\sin^{-1}(\frac{\sqrt{2}+\sqrt{6}}{4})$
 j) $\tan^{-1}(100,000)$ k) $\cos^{-1}(\frac{\sqrt{2-\sqrt{2}}}{2})$ l) $\tan^{-1}(2 + \sqrt{3} - \sqrt{6} - \sqrt{2})$

Session 20

Trigonometric equations

20.1 Basic trigonometric equations

In this section we solve equations such as:

$$\sin(x) = 0.5$$

We know that $x = \frac{\pi}{6}$ solves this equation. However, there are also other solutions such as $x = \frac{5\pi}{6}$ or $x = \frac{13\pi}{6}$ that can easily be checked with the calculator. Below, we will study how to find all solutions of equations of the form

$$\sin(x) = c, \quad \cos(x) = c, \quad \text{and} \quad \tan(x) = c.$$

We start with equations involving the tangent.

The equation $\tan(x) = c$

Example 20.1. Solve for x : $\tan(x) = \sqrt{3}$

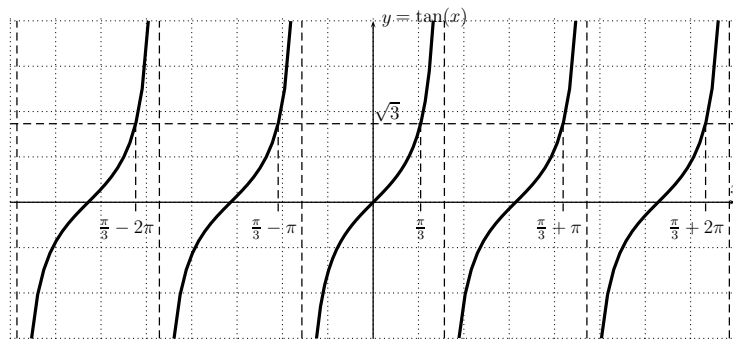

Solution. There is an obvious solution given by $x = \tan^{-1}(\sqrt{3}) = \frac{\pi}{3}$, as we studied in the last section. However, we can look for all solutions of $\tan(x) = \sqrt{3}$ by studying the graph of the tangent function, that is, by finding all points where the graph of the $y = \tan(x)$ intersects with the horizontal line $y = \sqrt{3}$. Since the function $y = \tan(x)$ is periodic with period π , we see that the other solutions of $\tan(x) = \sqrt{3}$ besides $x = \frac{\pi}{3}$ are

$$\frac{\pi}{3} + \pi, \quad \frac{\pi}{3} + 2\pi, \quad \frac{\pi}{3} + 3\pi, \dots, \quad \text{and} \quad \frac{\pi}{3} - \pi, \quad \frac{\pi}{3} - 2\pi, \quad \frac{\pi}{3} - 3\pi, \dots$$

In general, we write the solution as

$$x = \frac{\pi}{3} + n \cdot \pi, \quad \text{where } n = 0, \pm 1, \pm 2, \pm 3, \dots$$

The graph also shows that these are indeed all solutions of $\tan(x) = \sqrt{3}$. \square

By the same argument we also get the general solution of $\tan(x) = c$.

Observation 20.2. To solve $\tan(x) = c$, we first determine one solution $x = \tan^{-1}(c)$. Then the general solution is given by

$$\boxed{x = \tan^{-1}(c) + n \cdot \pi} \quad \text{where } n = 0, \pm 1, \pm 2, \pm 3, \dots \quad (20.1)$$

Example 20.3. Solve for x :

a) $\tan(x) = 1$, b) $\tan(x) = -1$, c) $\tan(x) = 5.1$, d) $\tan(x) = -3.7$

Solution. a) First, we find $\tan^{-1}(1) = \frac{\pi}{4}$. The general solution is thus:

$$x = \frac{\pi}{4} + n \cdot \pi \quad \text{where } n = 0, \pm 1, \pm 2, \pm 3, \dots$$

b) First, we need to find $\tan^{-1}(-1)$. Recall from equation (19.1) that $\tan^{-1}(-c) = -\tan^{-1}(c)$, and recall further that $\tan^{-1}(1) = \frac{\pi}{4}$. With this we have

$$\tan^{-1}(-1) = -\tan^{-1}(1) = -\frac{\pi}{4}$$

The general solution of $\tan(x) = -1$ is therefore,

$$x = -\frac{\pi}{4} + n \cdot \pi, \quad \text{where } n = 0, \pm 1, \pm 2, \dots$$

For parts (c) and (d), we do not have an exact solution, so that the solution can only be approximated with the calculator.

c) $x = \tan^{-1}(5.1) + n\pi \approx 1.377 + n\pi, \quad \text{where } n = 0, \pm 1, \pm 2, \dots$

d) $x = \tan^{-1}(-3.7) + n\pi \approx -1.307 + n\pi, \quad \text{where } n = 0, \pm 1, \pm 2, \dots$

\square

The equation $\cos(x) = c$

We start again with an example.

Example 20.4. Solve for x : $\cos(x) = \frac{1}{2}$

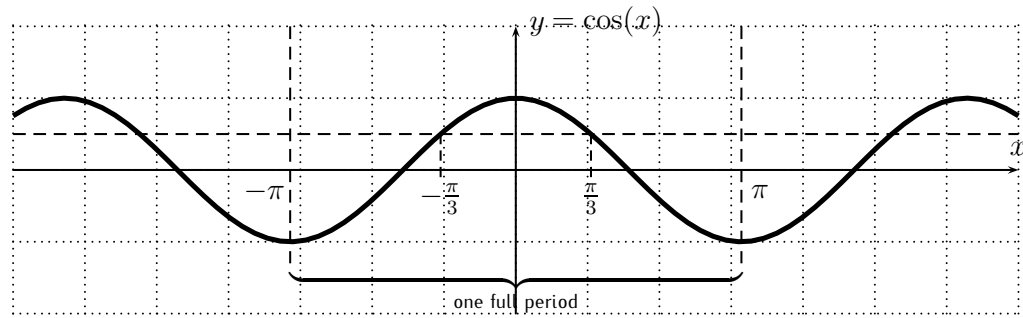

Solution. We have the obvious solution to the equation $x = \cos^{-1}(\frac{1}{2}) = \frac{\pi}{3}$. However, since $\cos(-x) = \cos(x)$, there is another solution given by taking $x = -\frac{\pi}{3}$:

$$\cos\left(-\frac{\pi}{3}\right) = \cos\left(\frac{\pi}{3}\right) = \frac{1}{2}$$

Moreover, the $y = \cos(x)$ function is periodic with period 2π , that is, we have $\cos(x + 2\pi) = \cos(x)$. Thus, all of the following numbers are solutions of the equation $\cos(x) = \frac{1}{2}$:

$$\begin{aligned} & \dots, \quad \frac{\pi}{3} - 4\pi, \quad \frac{\pi}{3} - 2\pi, \quad \frac{\pi}{3}, \quad \frac{\pi}{3} + 2\pi, \quad \frac{\pi}{3} + 4\pi, \quad \dots, \\ \text{and: } & \dots, \quad -\frac{\pi}{3} - 4\pi, \quad -\frac{\pi}{3} - 2\pi, \quad -\frac{\pi}{3}, \quad -\frac{\pi}{3} + 2\pi, \quad -\frac{\pi}{3} + 4\pi, \quad \dots \end{aligned}$$

From the graph we see that there are only two solutions of $\cos(x) = \frac{1}{2}$ within one period. Thus, the above list constitutes *all* solutions of the equation. With this observation, we may write the general solution as:

$$x = \frac{\pi}{3} + 2n \cdot \pi, \text{ or } x = -\frac{\pi}{3} + 2n \cdot \pi, \quad \text{where } n = 0, \pm 1, \pm 2, \pm 3, \dots$$

In short, we write this as: $x = \pm \frac{\pi}{3} + 2n \cdot \pi$ with $n = 0, \pm 1, \pm 2, \pm 3, \dots$ \square

We generalize this example as follows.

Observation 20.5. To solve $\cos(x) = c$, we first determine one solution $x = \cos^{-1}(c)$. Then the general solution is given by

$$x = \cos^{-1}(c) + 2n \cdot \pi, \text{ or } x = -\cos^{-1}(c) + 2n \cdot \pi, \quad \text{where } n = 0, \pm 1, \pm 2, \pm 3, \dots$$

In short, we write

$$\boxed{x = \pm \cos^{-1}(c) + 2n \cdot \pi} \quad \text{where } n = 0, \pm 1, \pm 2, \pm 3, \dots \quad (20.2)$$

Example 20.6. Solve for x .

a) $\cos(x) = -\frac{\sqrt{2}}{2}$, b) $\cos(x) = 0.6$, c) $\cos(x) = -3$, d) $\cos(x) = -1$

Solution. a) First, we need to find $\cos^{-1}(-\frac{\sqrt{2}}{2})$. From equation (19.3) we know that $\cos^{-1}(-c) = \pi - \cos^{-1}(c)$, so that:

$$\cos^{-1}\left(-\frac{\sqrt{2}}{2}\right) = \pi - \cos^{-1}\left(\frac{\sqrt{2}}{2}\right) = \pi - \frac{\pi}{4} = \frac{4\pi - \pi}{4} = \frac{3\pi}{4}$$

The solution is therefore,

$$x = \pm \frac{3\pi}{4} + 2n\pi, \quad \text{where } n = 0, \pm 1, \pm 2, \pm 3, \dots$$

b) We calculate $\cos^{-1}(0.6) \approx 0.927$ with the calculator. The general solution is therefore,

$$x = \pm \cos^{-1}(0.6) + 2n\pi \approx \pm 0.927 + 2n\pi, \quad \text{where } n = 0, \pm 1, \pm 2, \pm 3, \dots$$

c) Since the cosine is always $-1 \leq \cos(x) \leq 1$, the cosine can never be -3 . Therefore, there is *no solution* to the equation $\cos(x) = -3$. This can also be seen from the graph which does not intersect with the horizontal line $y = -3$.

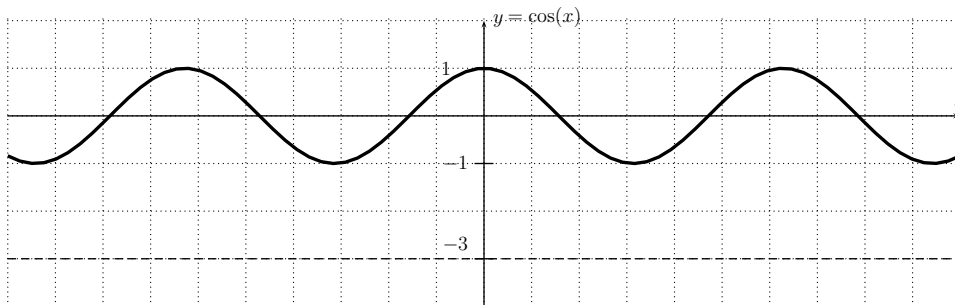

d) A special solution of $\cos(x) = -1$ is

$$\cos^{-1}(-1) = \pi - \cos^{-1}(1) = \pi - 0 = \pi,$$

so that the general solution is

$$x = \pm\pi + 2n\pi, \quad \text{where } n = 0, \pm 1, \pm 2, \pm 3, \dots$$

However, since $-\pi + 2\pi = +\pi$, the solutions $\pi + 2n\pi$ and $-\pi + 2n\pi$ (for $n = 0, \pm 1, \pm 2, \dots$) can be identified with each other, and there is only *one* solution in each period. Thus, the general solution can be written as

$$x = \pi + 2n\pi, \quad \text{where } n = 0, \pm 1, \pm 2, \pm 3, \dots$$

The graphs of $y = \cos(x)$ and $y = -1$ confirm these considerations.

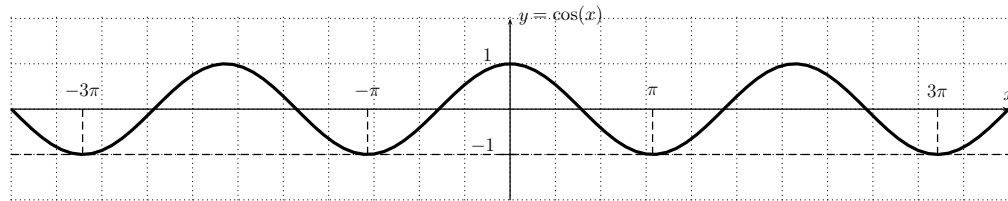

□

The equation $\sin(x) = c$

Example 20.7. Solve for x : $\sin(x) = \frac{\sqrt{2}}{2}$

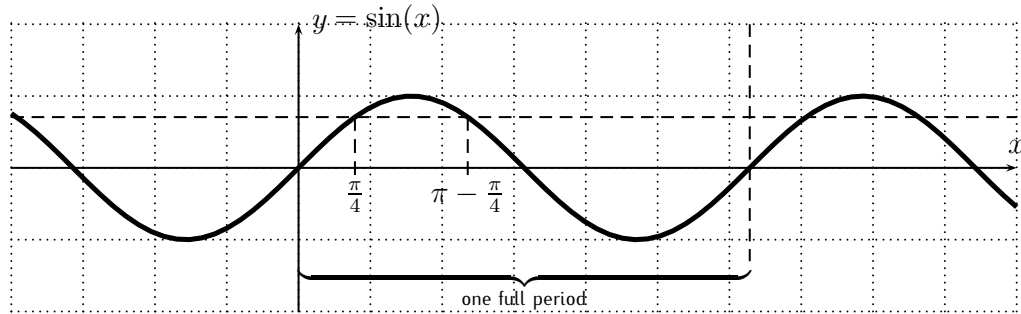

Solution. First, we can find one obvious solution $x = \sin^{-1}\left(\frac{\sqrt{2}}{2}\right) = \frac{\pi}{4}$. Furthermore, from the top right equation in (17.3), we have that $\sin(\pi - x) = \sin(x)$, so that another solution is given by $\pi - \frac{\pi}{4}$:

$$\sin\left(\pi - \frac{\pi}{4}\right) = \sin\left(\frac{\pi}{4}\right) = \frac{\sqrt{2}}{2}$$

(This can also be seen by going back to the unit circle definition.) These are all solutions within one period, as can be checked from the graph above. The

function $y = \sin(x)$ is periodic with period 2π , so that adding $2n \cdot \pi$ for any $n = 0, \pm 1, \pm 2, \dots$ gives all solutions of $\sin(x) = \frac{\sqrt{2}}{2}$. This means that the general solution is:

$$x = \frac{\pi}{4} + 2n \cdot \pi, \text{ or } x = \left(\pi - \frac{\pi}{4}\right) + 2n \cdot \pi, \quad \text{for } n = 0, \pm 1, \pm 2, \pm 3, \dots$$

We rewrite these solutions to obtain one single formula for the solutions. Note, that $\pi - \frac{\pi}{4} + 2n \cdot \pi = -\frac{\pi}{4} + (2n + 1) \cdot \pi$. Therefore, all solutions are of the form

$$x = \pm \frac{\pi}{4} + k \cdot \pi$$

where, for even $k = 2n$, the sign in front of $\frac{\pi}{4}$ is "+," and, for odd $k = 2n + 1$, the sign in front of $\frac{\pi}{4}$ is "-." This can be summarized as:

$$x = (-1)^k \cdot \frac{\pi}{4} + k \cdot \pi$$

Renaming the indexing variable k to the usual n , we obtain the final version for the solutions of $\sin(x) = \frac{\sqrt{2}}{2}$.

$$x = (-1)^n \cdot \frac{\pi}{4} + n \cdot \pi, \quad \text{where } n = 0, \pm 1, \pm 2, \pm 3, \dots$$

□

We have the following general statement.

Observation 20.8. To solve $\sin(x) = c$, we first determine one solution $x = \sin^{-1}(c)$. Then the general solution is given by

$$\boxed{x = (-1)^n \cdot \sin^{-1}(c) + n \cdot \pi} \quad \text{where } n = 0, \pm 1, \pm 2, \pm 3, \dots \quad (20.3)$$

Example 20.9. Solve for x .

$$\text{a) } \sin(x) = \frac{1}{2} \quad \text{b) } \sin(x) = -\frac{1}{2} \quad \text{c) } \sin(x) = -\frac{5}{7} \quad \text{d) } \sin(x) = 1$$

Solution. a) First, we calculate $\sin^{-1}\left(\frac{1}{2}\right) = \frac{\pi}{6}$. The general solution is therefore,

$$x = (-1)^n \cdot \frac{\pi}{6} + n \cdot \pi, \quad \text{where } n = 0, \pm 1, \pm 2, \pm 3, \dots$$

b) First, we need to find $\sin^{-1}(-\frac{1}{2})$. From equation (19.2) we know that $\sin^{-1}(-c) = -\sin^{-1}(c)$, so that $\sin^{-1}(-\frac{1}{2}) = -\sin^{-1}(\frac{1}{2}) = -\frac{\pi}{6}$. We thus state the general solution as

$$x = (-1)^n \cdot \left(-\frac{\pi}{6}\right) + n \cdot \pi = -(-1)^n \cdot \frac{\pi}{6} + n \cdot \pi = (-1)^{n+1} \cdot \frac{\pi}{6} + n \cdot \pi,$$

where $n = 0, \pm 1, \pm 2, \pm 3, \dots$

c) We do not have an exact value of $\sin^{-1}(-\frac{5}{7})$, so that we either need to leave it as this, or approximate this with the calculator $\sin^{-1}(-\frac{5}{7}) \approx -0.796$. We get the solution:

$$x \approx (-1)^n \cdot (-0.796) + n \cdot \pi = (-1)^{n+1} \cdot 0.796 + n \cdot \pi,$$

where $n = 0, \pm 1, \pm 2, \pm 3, \dots$

d) We calculate $\sin^{-1}(1) = \frac{\pi}{2}$. The general solution x can be written as

$$x = (-1)^n \cdot \frac{\pi}{2} + n \cdot \pi, \quad \text{where } n = 0, \pm 1, \pm 2, \pm 3, \dots \quad (20.4)$$

Now, if we look at the graph, we see that each period only has one solution.

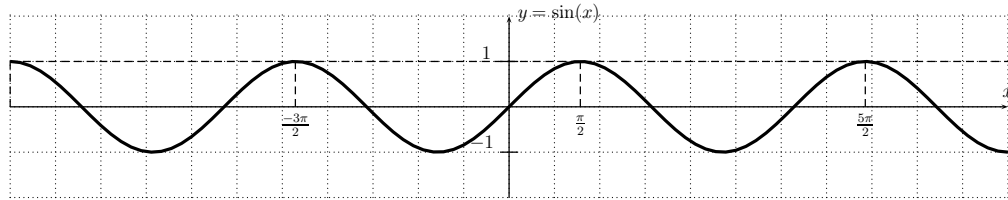

Algebraically, we can see this as follows. For an even number n , the solution $x = (-1)^n \cdot \frac{\pi}{2} + n \cdot \pi$ coincides with the solution coming from the index $n + 1$, that is:

$$\begin{aligned} (-1)^n \cdot \frac{\pi}{2} + n \cdot \pi &= +\frac{\pi}{2} + n \cdot \pi, \text{ and} \\ (-1)^{n+1} \cdot \frac{\pi}{2} + (n+1) \cdot \pi &= -\frac{\pi}{2} + (n+1) \cdot \pi = -\frac{\pi}{2} + n \cdot \pi + \pi \\ &= +\frac{\pi}{2} + n \cdot \pi \end{aligned}$$

Therefore, we can write the solution more efficiently by removing the odd solutions (since they coincide with the even solutions), and state this as

$$x = (-1)^n \cdot \frac{\pi}{2} + n \cdot \pi, \quad \text{where } n = 0, \pm 2, \pm 4, \dots$$

Since $(-1)^n = +1$ for even n , we can just write this as

$$x = \frac{\pi}{2} + 2n \cdot \pi, \quad \text{where } n = 0, \pm 1, \pm 2, \pm 3, \dots \quad (20.5)$$

Writing the solutions as $x = \frac{\pi}{2} + 2n \cdot \pi$ as in (20.5) instead of the original $x = (-1)^n \cdot \frac{\pi}{2} + n \cdot \pi$ from (20.4) for $n = 0, \pm 1, \pm 2, \dots$ certainly does not change the overall solution set. However, writing the solutions as in (20.5) is more efficient, since it *does not repeat* any of the solutions, and is therefore a simplified and preferred way of presenting the solutions. \square

Summary

We summarize the different formulas we used to solve the basic trigonometric equations in the following table.

Solve: $\sin(x) = c$	Solve: $\cos(x) = c$	Solve: $\tan(x) = c$
First, find one solution, that is: $\sin^{-1}(c)$. Use: $\sin^{-1}(-c) = -\sin^{-1}(c)$	First, find one solution, that is: $\cos^{-1}(c)$. Use: $\cos^{-1}(-c) = \pi - \cos^{-1}(c)$	First, find one solution, that is: $\tan^{-1}(c)$. Use: $\tan^{-1}(-c) = -\tan^{-1}(c)$
The general solution is: $x = (-1)^n \sin^{-1}(c) + n\pi$ where $n = 0, \pm 1, \pm 2, \dots$	The general solution is: $x = \pm \cos^{-1}(c) + 2n\pi$ where $n = 0, \pm 1, \pm 2, \dots$	The general solution is: $x = \tan^{-1}(c) + n\pi$ where $n = 0, \pm 1, \pm 2, \dots$

Example 20.10. Find the general solution of the equation, and state at least 5 distinct solutions.

$$\text{a) } \sin(x) = -\frac{1}{2} \qquad \text{b) } \cos(x) = -\frac{\sqrt{3}}{2}$$

Solution. a) We already calculated the general solution in example 20.9 (b). It is

$$x = (-1)^{n+1} \cdot \frac{\pi}{6} + n \cdot \pi, \quad \text{where } n = 0, \pm 1, \pm 2, \pm 3, \dots$$

We simplify the solutions for $n = 0, 1, -1, 2, -2$.

$$\begin{aligned} n = 0: \quad x &= (-1)^{0+1} \cdot \frac{\pi}{6} + 0 \cdot \pi = -\frac{\pi}{6} \\ n = 1: \quad x &= (-1)^{1+1} \cdot \frac{\pi}{6} + 1 \cdot \pi = \frac{\pi}{6} + \pi = \frac{\pi + 6\pi}{6} = \frac{7\pi}{6} \end{aligned}$$

$$n = -1: x = (-1)^{-1+1} \cdot \frac{\pi}{6} + (-1) \cdot \pi = \frac{\pi}{6} - \pi = \frac{\pi - 6\pi}{6} = \frac{-5\pi}{6}$$

$$n = 2: x = (-1)^{2+1} \cdot \frac{\pi}{6} + 2 \cdot \pi = -\frac{\pi}{6} + 2\pi = \frac{-\pi + 12\pi}{6} = \frac{11\pi}{6}$$

$$n = -2: x = (-1)^{-2+1} \cdot \frac{\pi}{6} + (-2) \cdot \pi = -\frac{\pi}{6} - 2\pi = \frac{-\pi - 12\pi}{6} = \frac{-13\pi}{6}$$

b) It is $\cos^{-1}\left(-\frac{\sqrt{3}}{2}\right) = \pi - \cos^{-1}\left(\frac{\sqrt{3}}{2}\right) = \pi - \frac{\pi}{6} = \frac{6\pi - \pi}{6} = \frac{5\pi}{6}$. The solutions of $\cos(x) = -\frac{\sqrt{3}}{2}$ are:

$$x = \pm \frac{5\pi}{6} + 2n\pi, \quad \text{where } n = 0, \pm 1, \pm 2, \pm 3, \dots$$

We write the 6 solutions with $n = 0, +1, -1$, and for each use the two distinct first terms $+\frac{5\pi}{6}$ and $-\frac{5\pi}{6}$.

$$n = 0: x = +\frac{5\pi}{6} + 2 \cdot 0 \cdot \pi = \frac{5\pi}{6}$$

$$n = 0: x = -\frac{5\pi}{6} + 2 \cdot 0 \cdot \pi = -\frac{5\pi}{6}$$

$$n = 1: x = +\frac{5\pi}{6} + 2 \cdot 1 \cdot \pi = \frac{5\pi}{6} + 2\pi = \frac{5\pi + 12\pi}{6} = \frac{17\pi}{6}$$

$$n = 1: x = -\frac{5\pi}{6} + 2 \cdot 1 \cdot \pi = -\frac{5\pi}{6} + 2\pi = \frac{-5\pi + 12\pi}{6} = \frac{7\pi}{6}$$

$$n = -1: x = +\frac{5\pi}{6} + 2 \cdot (-1) \cdot \pi = \frac{5\pi}{6} - 2\pi = \frac{5\pi - 12\pi}{6} = \frac{-7\pi}{6}$$

$$n = -1: x = -\frac{5\pi}{6} + 2 \cdot (-1) \cdot \pi = -\frac{5\pi}{6} - 2\pi = \frac{-5\pi - 12\pi}{6} = \frac{-17\pi}{6}$$

Further solutions can be found by taking values $n = +2, -2, +3, -3, \dots$ \square

20.2 Equations involving trigonometric functions

The previous section showed how to solve the basic trigonometric equations

$$\sin(x) = c, \quad \cos(x) = c, \quad \text{and} \quad \tan(x) = c.$$

The next examples can be reduced to these basic equations.

Example 20.11. Solve for x .

$$\text{a) } 2 \sin(x) - 1 = 0 \quad \text{b) } \sec(x) = -\sqrt{2} \quad \text{c) } 7 \cot(x) + 3 = 0$$

Solution. a) Solving for $\sin(x)$, we get

$$2 \sin(x) - 1 = 0 \xrightarrow{(+1)} 2 \sin(x) = 1 \xrightarrow{(\div 2)} \sin(x) = \frac{1}{2}$$

One solution of $\sin(x) = \frac{1}{2}$ is $\sin^{-1}(\frac{1}{2}) = \frac{\pi}{6}$. The general solution is

$$x = (-1)^n \cdot \frac{\pi}{6} + n\pi, \quad \text{where } n = 0, \pm 1, \pm 2, \dots$$

b) Recall that $\sec(x) = \frac{1}{\cos(x)}$. Therefore,

$$\sec(x) = -\sqrt{2} \implies \frac{1}{\cos(x)} = -\sqrt{2} \xrightarrow{\text{(reciprocal)}} \cos(x) = -\frac{1}{\sqrt{2}} = -\frac{\sqrt{2}}{2}$$

A special solution of $\cos(x) = -\frac{\sqrt{2}}{2}$ is

$$\cos^{-1}\left(-\frac{\sqrt{2}}{2}\right) = \pi - \cos^{-1}\left(\frac{\sqrt{2}}{2}\right) = \pi - \frac{\pi}{4} = \frac{4\pi - \pi}{4} = \frac{3\pi}{4}.$$

The general solution is

$$x = \pm \frac{3\pi}{4} + 2n\pi, \quad \text{where } n = 0, \pm 1, \pm 2, \dots$$

c) Recall that $\cot(x) = \frac{1}{\tan(x)}$. So

$$\begin{aligned} 7 \cot(x) + 3 = 0 &\xrightarrow{(-3)} 7 \cot(x) = -3 \xrightarrow{(\div 7)} \cot(x) = -\frac{3}{7} \\ &\implies \frac{1}{\tan(x)} = -\frac{3}{7} \xrightarrow{\text{(reciprocal)}} \tan(x) = -\frac{7}{3} \end{aligned}$$

The solution is

$$x = \tan^{-1}\left(-\frac{7}{3}\right) + n\pi \approx -1.166 + n\pi, \quad \text{where } n = 0, \pm 1, \pm 2, \dots$$

□

For some of the more advanced problems it can be helpful to substitute u for a trigonometric expression first, then solve for u , and finally apply the rules from the previous section to solve for the wanted variable. This method is used in the next example.

Example 20.12. Solve for x .

$$\text{a) } \tan^2(x) + 2 \tan(x) + 1 = 0 \quad \text{b) } 2 \cos^2(x) - 1 = 0$$

Solution. a) Substituting $u = \tan(x)$, we have to solve the equation

$$u^2 + 2u + 1 = 0 \xrightarrow{\text{(factor)}} (u + 1)(u + 1) = 0 \implies u + 1 = 0 \xrightarrow{(-1)} u = -1$$

Resubstituting $u = \tan(x)$, we have to solve $\tan(x) = -1$. Using the fact that $\tan^{-1}(-1) = -\tan^{-1}(1) = -\frac{\pi}{4}$, we have the general solution

$$x = -\frac{\pi}{4} + n\pi, \quad \text{where } n = 0, \pm 1, \pm 2, \dots$$

b) We substitute $u = \cos(x)$, then we have

$$\begin{aligned} 2u^2 - 1 = 0 &\xrightarrow{(+1)} 2u^2 = 1 \xrightarrow{(\div 2)} u^2 = \frac{1}{2} \\ &\implies u = \pm \sqrt{\frac{1}{2}} = \pm \frac{1}{\sqrt{2}} = \pm \frac{\sqrt{2}}{2} \\ &\implies u = +\frac{\sqrt{2}}{2} \quad \text{or} \quad u = -\frac{\sqrt{2}}{2} \end{aligned}$$

For each of the two cases we need to solve the corresponding equation after replacing $u = \cos(x)$.

$$\begin{array}{l|l} \begin{array}{l} \cos(x) = \frac{\sqrt{2}}{2} \\ \text{with } \cos^{-1}\left(\frac{\sqrt{2}}{2}\right) = \frac{\pi}{4} \\ \implies x = \pm \frac{\pi}{4} + 2n\pi \\ \text{where } n = 0, \pm 1, \pm 2, \dots \end{array} & \begin{array}{l} \cos(x) = -\frac{\sqrt{2}}{2} \\ \text{with } \cos^{-1}\left(-\frac{\sqrt{2}}{2}\right) = \pi - \cos^{-1}\left(\frac{\sqrt{2}}{2}\right) \\ \quad = \pi - \frac{\pi}{4} = \frac{3\pi}{4} \\ \implies x = \pm \frac{3\pi}{4} + 2n\pi \\ \text{where } n = 0, \pm 1, \pm 2, \dots \end{array} \end{array}$$

Thus, the general solution is

$$x = \pm \frac{\pi}{4} + 2n\pi, \quad \text{or} \quad x = \pm \frac{3\pi}{4} + 2n\pi, \quad \text{where } n = 0, \pm 1, \pm 2, \dots$$

□

Example 20.13. Solve the equation with the calculator. Approximate the solution to the nearest thousandth.

a) $2 \sin(x) = 4 \cos(x) + 3$ b) $5 \cos(2x) = \tan(x)$

Solution. a) We rewrite the equation as $2 \sin(x) - 4 \cos(x) - 3 = 0$, and use the calculator to find the graph of the function $f(x) = 2 \sin(x) - 4 \cos(x) - 3$. The zeros of the function f are the solutions of the initial equation. The graph that we obtain is displayed below.

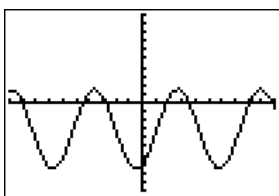

The graph indicates that the function $f(x) = 2 \sin(x) - 4 \cos(x) - 3$ is periodic. This can be confirmed by observing that both $\sin(x)$ and $\cos(x)$ are periodic with period 2π , and thus also $f(x)$.

$$f(x + 2\pi) = 2 \sin(x + 2\pi) - 4 \cos(x + 2\pi) - 3 = 2 \sin(x) - 4 \cos(x) - 3 = f(x)$$

The solution of $f(x) = 0$ can be obtained by finding the “zeros,” that is by pressing , then choosing a left- and right-bound, and making a guess for the zero. Repeating this procedure gives the following two approximate solutions within one period.

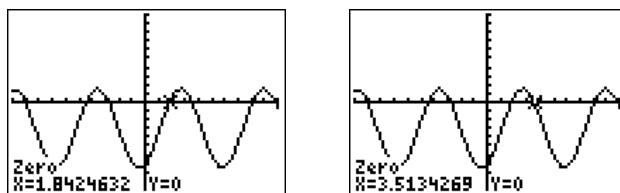

The general solution is thus

$$x \approx 1.842 + 2n\pi \quad \text{or} \quad x \approx 3.513 + 2n\pi, \quad \text{where } n = 0, \pm 1, \pm 2, \dots$$

b) We rewrite the equation as $5 \cos(2x) - \tan(x) = 0$ and graph the

function $f(x) = 5 \cos(2x) - \tan(x)$ in the standard window.

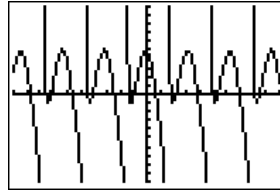

To get a better view of the function we zoom to a more appropriate window.

```

WINDOW
Xmin=-2
Xmax=6
Xscl=1
Ymin=-3
Ymax=7
Yscl=1
↓Xres=1
  
```

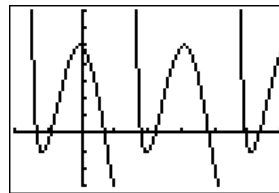

Note again that the function f is periodic. The period of $\cos(2x)$ is $\frac{2\pi}{2} = \pi$ (see definition 17.9 on page 246), and the period of $\tan(x)$ is also π (see equation (17.6) on page 243). Thus, f is also periodic with period π . The solutions in one period are approximated by finding the zeros with the calculator.

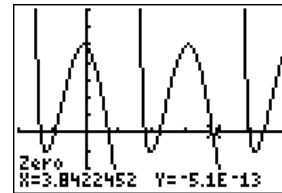
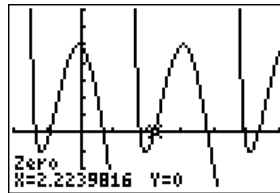
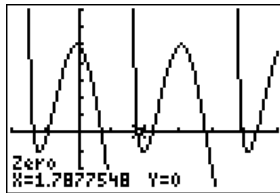

The general solution is given by any of these numbers, with possibly an additional shift by any multiple of π .

$$x \approx 1.788 + n\pi \quad \text{or} \quad x \approx 2.224 + n\pi \quad \text{or} \quad x \approx 3.842 + n\pi,$$

where $n = 0, \pm 1, \pm 2, \pm 3, \dots$

□

20.3 Exercises

Exercise 20.1. Find all solutions of the equation, and simplify as much as possible. Do not approximate the solution.

$$\begin{array}{llll} \text{a) } \tan(x) = \frac{\sqrt{3}}{3} & \text{b) } \sin(x) = \frac{\sqrt{3}}{2} & \text{c) } \sin(x) = -\frac{\sqrt{2}}{2} & \text{d) } \cos(x) = \frac{\sqrt{3}}{2} \\ \text{e) } \cos(x) = 0 & \text{f) } \cos(x) = -0.5 & \text{g) } \cos(x) = 1 & \text{h) } \sin(x) = 5 \\ \text{i) } \sin(x) = 0 & \text{j) } \sin(x) = -1 & \text{k) } \tan(x) = -\sqrt{3} & \text{l) } \cos(x) = 0.2 \end{array}$$

Exercise 20.2. Find all solutions of the equation. Approximate your solution with the calculator.

$$\begin{array}{lll} \text{a) } \tan(x) = 6.2 & \text{b) } \cos(x) = 0.45 & \text{c) } \sin(x) = 0.91 \\ \text{d) } \cos(x) = -.772 & \text{e) } \tan(x) = -0.2 & \text{f) } \sin(x) = -0.06 \end{array}$$

Exercise 20.3. Find at least 5 distinct solutions of the equation.

$$\begin{array}{llll} \text{a) } \tan(x) = -1 & \text{b) } \cos(x) = \frac{\sqrt{2}}{2} & \text{c) } \sin(x) = -\frac{\sqrt{3}}{2} & \text{d) } \tan(x) = 0 \\ \text{e) } \cos(x) = 0 & \text{f) } \cos(x) = 0.3 & \text{g) } \sin(x) = 0.4 & \text{h) } \sin(x) = -1 \end{array}$$

Exercise 20.4. Solve for x . State the general solution without approximation.

$$\begin{array}{ll} \text{a) } \tan(x) - 1 = 0 & \text{b) } 2 \sin(x) = 1 \\ \text{c) } 2 \cos(x) - \sqrt{3} = 0 & \text{d) } \sec(x) = -2 \\ \text{e) } \cot(x) = \sqrt{3} & \text{f) } \tan^2(x) - 3 = 0 \\ \text{g) } \sin^2(x) - 1 = 0 & \text{h) } \cos^2(x) + 7 \cos(x) + 6 = 0 \\ \text{i) } 4 \cos^2(x) - 4 \cos(x) + 1 = 0 & \text{j) } 2 \sin^2(x) + 11 \sin(x) = -5 \\ \text{k) } 2 \sin^2(x) + \sin(x) - 1 = 0 & \text{l) } 2 \cos^2(x) - 3 \cos(x) + 1 = 0 \\ \text{m) } 2 \cos^2(x) + 9 \cos(x) = 5 & \text{n) } \tan^3(x) - \tan(x) = 0 \end{array}$$

Exercise 20.5. Use the calculator to find all solutions of the given equation. Approximate the answer to the nearest thousandth.

$$\begin{array}{ll} \text{a) } 2 \cos(x) = 2 \sin(x) + 1 & \text{b) } 7 \tan(x) \cdot \cos(2x) = 1 \\ \text{c) } 4 \cos^2(3x) + \cos(3x) = \sin(3x) + 2 & \text{d) } \sin(x) + \tan(x) = \cos(x) \end{array}$$

Review of trigonometric functions

Exercise IV.1. Fill in all the trigonometric function values in the table below.

	0	$\frac{\pi}{6}$	$\frac{\pi}{4}$	$\frac{\pi}{3}$	$\frac{\pi}{2}$
$\sin(x)$					
$\cos(x)$					
$\tan(x)$					

Exercise IV.2. Find the exact values of

a) $\cos\left(-\frac{\pi}{6}\right)$ b) $\sin\left(-\frac{\pi}{4}\right)$ c) $\tan\left(-\frac{\pi}{3}\right)$

Exercise IV.3. Find the exact value of the trigonometric function.

a) $\sin\left(\frac{5\pi}{4}\right)$ b) $\cos\left(\frac{11\pi}{6}\right)$

[Hint: Use the special $45^\circ - 45^\circ - 90^\circ$ or $30^\circ - 60^\circ - 90^\circ$ triangles to find the solution.]

Exercise IV.4. Find the amplitude, period, and the phase shift of the given function. Draw the graph over a one-period interval. Label all maxima, minima and intercepts.

a) $y = 3 \cos(4x - \pi)$ b) $y = -5 \sin\left(x + \frac{\pi}{2}\right)$

Exercise IV.5. Find the exact trigonometric function value.

a) $\cos\left(\frac{\pi}{12}\right)$ [Hint: Use the addition and subtraction of angles formulas.]

b) $\cos\left(\frac{3\pi}{8}\right)$ [Hint: Use the half-angles formulas.]

Exercise IV.6. Let $\sin(\alpha) = -\frac{4}{5}$ and let α be in quadrant III. Find $\sin(2\alpha)$, $\cos(2\alpha)$, and $\tan(2\alpha)$.

Exercise IV.7. Find the exact value of:

$$\text{a) } \sin^{-1}\left(-\frac{1}{2}\right) \quad \text{b) } \cos^{-1}\left(-\frac{\sqrt{3}}{2}\right) \quad \text{c) } \tan^{-1}\left(-\frac{\sqrt{3}}{3}\right)$$

Exercise IV.8. Solve for x : $2 \sin(x) + \sqrt{3} = 0$

Exercise IV.9. Solve for x : $\tan^2(x) - 1 = 0$

Exercise IV.10. Solve for x .

$$\text{a) } 2 \cos^2(x) - 1 = 0 \quad \text{b) } 2 \sin^2(x) + 15 \sin(x) + 7 = 0$$

Part V

Complex numbers, sequences, and the binomial theorem

Session 21

Complex numbers

21.1 Polar form of complex numbers

We now recall the definition of complex numbers and show how they are represented on the complex plane.

Definition 21.1. We define the **imaginary unit** or **complex unit** to be

$$\text{imaginary unit: } \boxed{i = \sqrt{-1}} \quad (21.1)$$

In other words, i is a solution of the equation:

$$\boxed{i^2 = -1} \quad (21.2)$$

Definition 21.2. A **complex number** is a number of the form $a + b \cdot i$. (Alternatively we also write this as $a + bi$ without the dot for the multiplication.) Here a and b are any real numbers. The number a is called the **real part** of $a + b \cdot i$, and b is called the **imaginary part** of $a + b \cdot i$. The set of all complex numbers is denoted by \mathbb{C} .

Here are some examples of complex numbers:

$$3 + 2i, \quad 1 - 1 \cdot i, \quad \sqrt{2} + \pi \cdot i, \quad 5 + 0 \cdot i, \quad 0 + 3 \cdot i$$

Note that in the last two examples, we have $5 + 0 \cdot i = 5$, so that we see that the real number 5 is also a complex number. Indeed, any real number $a = a + 0 \cdot i$ is also a complex number. Similarly, $0 + 3 \cdot i = 3i$ as well as any

multiple of i is also a complex number (these numbers are often called pure imaginary numbers).

In analogy to section 1.1, where we represented the real numbers on the number line, we can represent the complex numbers on the *complex plane*:

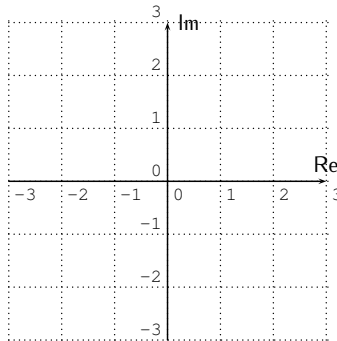

The complex number $a + bi$ is represented as the point with coordinates (a, b) in the complex plane.

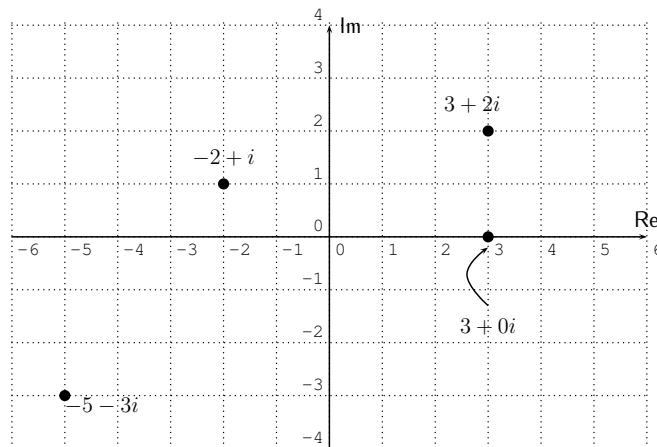

Example 21.3. Perform the operation.

$$\text{a) } (2 - 3i) + (-6 + 4i) \quad \text{b) } (3 + 5i) \cdot (-7 + i) \quad \text{c) } \frac{5 + 4i}{3 + 2i}$$

Solution. a) Adding real and imaginary parts, respectively, gives,

$$(2 - 3i) + (-6 + 4i) = 2 - 3i - 6 + 4i = -4 + i.$$

b) We multiply (using FOIL), and use that $i^2 = -1$.

$$(3 + 5i) \cdot (-7 + i) = -21 + 3i - 35i + 5i^2 = -21 - 32i + 5 \cdot (-1)$$

$$= -21 - 32i - 5 = -26 - 32i$$

c) Recall that we may simplify a quotient of complex numbers by multiplying numerator and denominator by the conjugate of the denominator.

$$\begin{aligned} \frac{5 + 4i}{3 + 2i} &= \frac{(5 + 4i) \cdot (3 - 2i)}{(3 + 2i) \cdot (3 - 2i)} = \frac{15 - 10i + 12i - 8i^2}{9 - 6i + 6i - 4i^2} \\ &= \frac{15 + 2i + 8}{9 + 4} = \frac{23 + 2i}{13} = \frac{23}{13} + \frac{2}{13}i \end{aligned}$$

The real part of the solution is $\frac{23}{13}$; the imaginary part is $\frac{2}{13}$. \square

There is also a notion of *absolute value* $|a + bi|$ for any complex number $a + bi$.

Definition 21.4. Let $a + bi$ be a complex number. The **absolute value** of $a + bi$, denoted by $|a + bi|$ is the length between the point $a + bi$ in the complex plane and the origin $(0, 0)$.

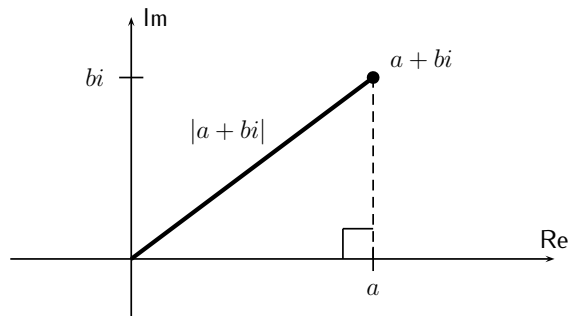

Using the Pythagorean theorem, we can calculate $|a + bi|$ as

$$|a + bi|^2 = a^2 + b^2,$$

so that

$$\boxed{|a + bi| = \sqrt{a^2 + b^2}} \quad (21.3)$$

Example 21.5. Find the absolute value of the complex numbers below.

- a) $5 - 3i$ b) $-8 + 6i$ c) $7i$

Solution. The absolute values are calculated as follows.

- a) $|5 - 3i| = \sqrt{5^2 + (-3)^2} = \sqrt{25 + 9} = \sqrt{34}$
 b) $|-8 + 6i| = \sqrt{(-8)^2 + 6^2} = \sqrt{64 + 36} = \sqrt{100} = 10$
 c) $|7i| = \sqrt{0^2 + (7)^2} = \sqrt{0 + 49} = 7$

□

We can write a complex number in the form $a + bi$, or alternatively, we may use the absolute value and “angle” to write the number in the so-called *polar form*, which we discuss now.

Observation 21.6. Let $a + bi$ be a complex number. The coordinates in the plane can be expressed in terms of the absolute value $r = |a + bi|$ and the angle θ with the real axis as shown below.

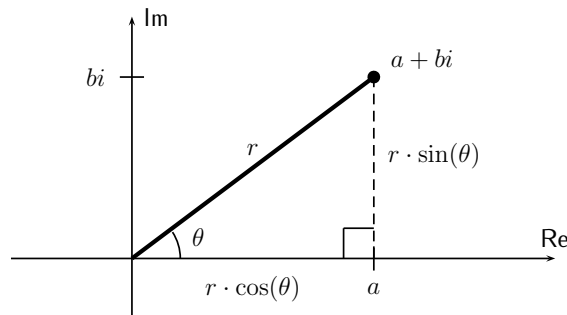

From the right triangle as shown in the complex plane above, we see that the coordinates a and b in the plane are given by:

$$a = r \cdot \cos(\theta) \quad \text{and} \quad b = r \cdot \sin(\theta) \quad (21.4)$$

Therefore, the complex number is $a + bi = r \cdot \cos(\theta) + r \cdot \sin(\theta) \cdot i$, or factoring r from this expression:

$$\boxed{a + bi = r \cdot (\cos(\theta) + i \cdot \sin(\theta))} \quad (21.5)$$

Writing the complex number in this way is called the **polar form** of the complex number. Here, the number r is the absolute value, and θ is given by (21.4) via the calculation $\frac{b}{a} = \frac{r \cdot \sin(\theta)}{r \cdot \cos(\theta)} = \frac{\sin(\theta)}{\cos(\theta)} = \tan(\theta)$. Thus,

$$\boxed{r = \sqrt{a^2 + b^2}} \quad \text{and} \quad \boxed{\tan(\theta) = \frac{b}{a}} \quad (21.6)$$

When finding the directional angle θ of a complex number via equation (21.6), we have to remember that $\tan(\theta)$ may be obtained by the two angles θ and $\pi + \theta$; that is, we have

$$\tan(\pi + \theta) = \tan(\theta).$$

Therefore, we need to check that our answer for θ lies in the correct quadrant. This is shown in the next example.

Example 21.7. Convert the complex number to polar form.

$$\text{a) } 2 + 3i, \quad \text{b) } -2 - 2\sqrt{3}i, \quad \text{c) } 4 - 3i, \quad \text{d) } -4i$$

Solution. a) First, the absolute value is $r = |2 + 3i| = \sqrt{2^2 + 3^2} = \sqrt{13}$. Furthermore, since $a = 2$ and $b = 3$, we have $\tan(\theta) = \frac{3}{2}$. To obtain θ , we calculate

$$\tan^{-1}\left(\frac{3}{2}\right) \approx 56.3^\circ$$

Note that 56.3° is in the first quadrant, and so is the complex number $2 + 3i$

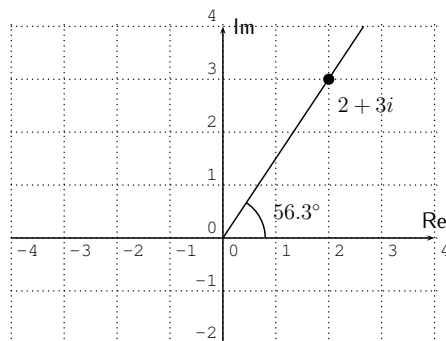

Therefore, $\theta \approx 56.3^\circ$, and we obtain our answer:

$$2 + 3i \approx \sqrt{13} \cdot \left(\cos(56.3^\circ) + i \sin(56.3^\circ) \right).$$

b) For $-2 - 2\sqrt{3}i$, we first calculate the absolute value:

$$r = \sqrt{(-2)^2 + (-2\sqrt{3})^2} = \sqrt{4 + 4 \cdot 3} = \sqrt{4 + 12} = \sqrt{16} = 4.$$

Furthermore, $\tan(\theta) = \frac{b}{a} = \frac{-2\sqrt{3}}{-2} = \sqrt{3}$. Now, $\tan^{-1}(\sqrt{3}) = 60^\circ = \frac{\pi}{3}$. However, graphing the angle $\frac{\pi}{3} = 60^\circ$ and the number $-2 - 2\sqrt{3}i$, we see that 60°

is in the first quadrant, whereas $-2 - 2\sqrt{3}i$ is in the third quadrant.

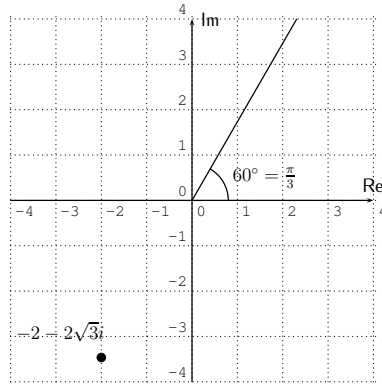

Therefore, we have to add π to $\frac{\pi}{3}$ to get the correct angle for $-2 - 2\sqrt{3}i$, that is $\theta = \frac{\pi}{3} + \pi = \frac{\pi+3\pi}{3} = \frac{4\pi}{3}$. Our complex number in polar form is

$$-2 - 2\sqrt{3}i = 4 \cdot \left(\cos\left(\frac{4\pi}{3}\right) + i \sin\left(\frac{4\pi}{3}\right) \right).$$

c) For $4 - 3i$ we calculate $r = \sqrt{4^2 + (-3)^2} = \sqrt{16 + 9} = \sqrt{25} = 5$. The angle $\tan^{-1}\left(\frac{-3}{4}\right) \approx -36.9^\circ$, which is in the fourth quadrant, just like the number $4 - 3i$.

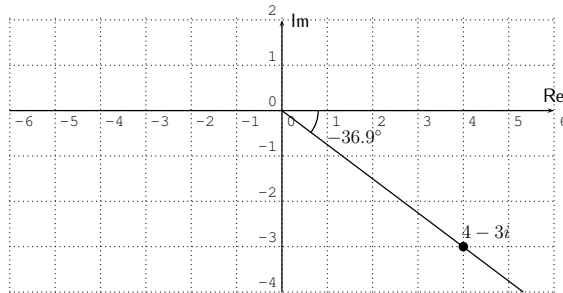

Therefore, $\theta \approx -36.9^\circ$, and we write

$$4 - 3i \approx 5 \cdot \left(\cos(-36.9^\circ) + i \sin(-36.9^\circ) \right)$$

d) We calculate the absolute value of $0 - 4i$ as $r = \sqrt{0^2 + (-4)^2} = \sqrt{16} = 4$. However, when calculating the angle θ of $0 - 4i$, we are lead to consider $\tan^{-1}\left(\frac{-4}{0}\right)$, which is *undefined*! The reason for this can be seen by plotting

the number $-4i$ in the complex plane.

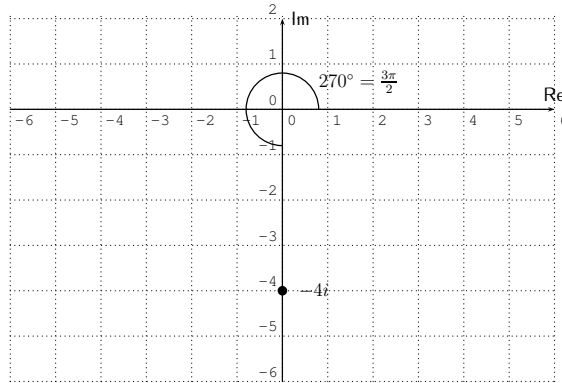

The angle $\theta = 270^\circ$ (or alternatively $\theta = -90^\circ$), so that the complex number is

$$\begin{aligned} -4i &= 4 \cdot (\cos(270^\circ) + i \sin(270^\circ)) \\ &= 4 \cdot \left(\cos\left(\frac{3\pi}{2}\right) + i \sin\left(\frac{3\pi}{2}\right) \right) \end{aligned}$$

Note that we may write our answer either in degree or radian mode as we did above. \square

We may also perform the reverse conversion of a complex number from polar form into “standard form” $a + bi$.

Example 21.8. Convert the number from polar form into the standard form $a + bi$.

$$\text{a) } 3 \cdot (\cos(117^\circ) + i \sin(117^\circ)) \quad \text{b) } 4 \cdot (\cos(\frac{5\pi}{4}) + i \sin(\frac{5\pi}{4}))$$

Solution. a) Since we don’t have an exact formula for $\cos(117^\circ)$ or $\sin(117^\circ)$, we use the calculator to obtain approximate values.

$$3 \cdot (\cos(117^\circ) + i \sin(117^\circ)) \approx 3 \cdot (-0.454 + i \cdot 0.891) = -1.362 + 2.673i$$

b) We recall that $\cos(\frac{5\pi}{4}) = -\frac{\sqrt{2}}{2}$ and $\sin(\frac{5\pi}{4}) = -\frac{\sqrt{2}}{2}$. (This can be seen as in Example 17.6 on page 237 by considering the point $P(-1, -1)$ on the

terminal side of the angle $\frac{5\pi}{4} = \frac{5 \cdot 180^\circ}{4} = 225^\circ$.

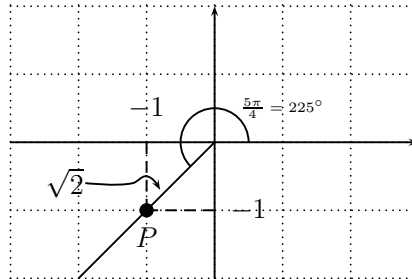

Therefore, $\cos(\frac{5\pi}{4}) = \frac{-1}{\sqrt{2}} = -\frac{\sqrt{2}}{2}$ and $\sin(\frac{5\pi}{4}) = \frac{-1}{\sqrt{2}} = -\frac{\sqrt{2}}{2}$.

With this, we obtain the complex number in standard form.

$$\begin{aligned} 4 \cdot \left(\cos\left(\frac{5\pi}{4}\right) + i \sin\left(\frac{5\pi}{4}\right) \right) &= 4 \cdot \left(-\frac{\sqrt{2}}{2} - i \frac{\sqrt{2}}{2} \right) \\ &= -4 \frac{\sqrt{2}}{2} - i \cdot 4 \frac{\sqrt{2}}{2} = -2\sqrt{2} - 2\sqrt{2} \cdot i \end{aligned}$$

□

21.2 Multiplication and division of complex numbers in polar form

One interesting feature of the polar form of a complex number is that the multiplication and division are very easy to perform.

Proposition 21.9. Let $r_1(\cos(\theta_1) + i \sin(\theta_1))$ and $r_2(\cos(\theta_2) + i \sin(\theta_2))$ be two complex numbers in polar form. Then, the product and quotient of these are given by

$$\begin{aligned} r_1(\cos(\theta_1) + i \sin(\theta_1)) \cdot r_2(\cos(\theta_2) + i \sin(\theta_2)) \\ = r_1 r_2 \cdot (\cos(\theta_1 + \theta_2) + i \sin(\theta_1 + \theta_2)) \end{aligned} \quad (21.7)$$

$$\frac{r_1(\cos(\theta_1) + i \sin(\theta_1))}{r_2(\cos(\theta_2) + i \sin(\theta_2))} = \frac{r_1}{r_2} \cdot (\cos(\theta_1 - \theta_2) + i \sin(\theta_1 - \theta_2)) \quad (21.8)$$

21.2. MULTIPLICATION AND DIVISION OF COMPLEX NUMBERS 295

Proof. The proof uses the addition formulas for trigonometric functions $\sin(\alpha + \beta)$ and $\cos(\alpha + \beta)$ from proposition 18.1 on page 252.

$$\begin{aligned} & r_1(\cos(\theta_1) + i \sin(\theta_1)) \cdot r_2(\cos(\theta_2) + i \sin(\theta_2)) \\ &= r_1 r_2 \cdot (\cos(\theta_1) \cos(\theta_2) + i \cos(\theta_1) \sin(\theta_2) + i \sin(\theta_1) \cos(\theta_2) + i^2 \sin(\theta_1) \sin(\theta_2)) \\ &= r_1 r_2 \cdot ((\cos(\theta_1) \cos(\theta_2) - \sin(\theta_1) \sin(\theta_2)) + i(\cos(\theta_1) \sin(\theta_2) + \sin(\theta_1) \cos(\theta_2))) \\ &= r_1 r_2 \cdot (\cos(\theta_1 + \theta_2) + i \sin(\theta_1 + \theta_2)) \end{aligned}$$

For the division formula, note, that the multiplication formula (21.7) gives

$$\begin{aligned} r_2(\cos(\theta_2) + i \sin(\theta_2)) \cdot \frac{1}{r_2}(\cos(-\theta_2) + i \sin(-\theta_2)) &= r_2 \frac{1}{r_2}(\cos(\theta_2 - \theta_2) + i \sin(\theta_2 - \theta_2)) \\ &= 1 \cdot (\cos 0 + i \sin 0) = 1 \cdot (1 + i \cdot 0) = 1 \\ \implies \frac{1}{r_2(\cos(\theta_2) + i \sin(\theta_2))} &= \frac{1}{r_2}(\cos(-\theta_2) + i \sin(-\theta_2)), \end{aligned}$$

so that

$$\begin{aligned} \frac{r_1(\cos(\theta_1) + i \sin(\theta_1))}{r_2(\cos(\theta_2) + i \sin(\theta_2))} &= r_1(\cos(\theta_1) + i \sin(\theta_1)) \cdot \frac{1}{r_2(\cos(\theta_2) + i \sin(\theta_2))} \\ &= r_1(\cos(\theta_1) + i \sin(\theta_1)) \cdot \frac{1}{r_2}(\cos(-\theta_2) + i \sin(-\theta_2)) = \frac{r_1}{r_2} \cdot (\cos(\theta_1 - \theta_2) + i \sin(\theta_1 - \theta_2)). \end{aligned}$$

□

Example 21.10. Multiply or divide the complex numbers, and write your answer in polar and standard form.

- a) $5(\cos(11^\circ) + i \sin(11^\circ)) \cdot 8(\cos(34^\circ) + i \sin(34^\circ))$
 b) $3(\cos(\frac{5\pi}{8}) + i \sin(\frac{5\pi}{8})) \cdot 12(\cos(\frac{7\pi}{8}) + i \sin(\frac{7\pi}{8}))$
 c) $\frac{32(\cos(\frac{\pi}{4}) + i \sin(\frac{\pi}{4}))}{8(\cos(\frac{7\pi}{12}) + i \sin(\frac{7\pi}{12}))}$ d) $\frac{4(\cos(203^\circ) + i \sin(203^\circ))}{6(\cos(74^\circ) + i \sin(74^\circ))}$

Solution. We will multiply and divide the complex numbers using equations (21.7) and (21.8), respectively, and then convert them to standard notation $a + bi$.

a)
$$\begin{aligned} & 5(\cos(11^\circ) + i \sin(11^\circ)) \cdot 8(\cos(34^\circ) + i \sin(34^\circ)) \\ &= 5 \cdot 8 \cdot (\cos(11^\circ + 34^\circ) + i \sin(11^\circ + 34^\circ)) = 40(\cos(45^\circ) + i \sin(45^\circ)) \\ &= 40\left(\frac{\sqrt{2}}{2} + i \frac{\sqrt{2}}{2}\right) = 40 \frac{\sqrt{2}}{2} + i \cdot 40 \frac{\sqrt{2}}{2} = 20\sqrt{2} + 20\sqrt{2}i \end{aligned}$$

b) Similarly, we obtain the next product.

$$\begin{aligned} 3\left(\cos\left(\frac{5\pi}{8}\right) + i\sin\left(\frac{5\pi}{8}\right)\right) \cdot 12\left(\cos\left(\frac{7\pi}{8}\right) + i\sin\left(\frac{7\pi}{8}\right)\right) \\ = 36\left(\cos\left(\frac{5\pi}{8} + \frac{7\pi}{8}\right) + i\sin\left(\frac{5\pi}{8} + \frac{7\pi}{8}\right)\right) \end{aligned}$$

Now, $\frac{5\pi}{8} + \frac{7\pi}{8} = \frac{5\pi + 7\pi}{8} = \frac{12\pi}{8} = \frac{3\pi}{2}$, and $\cos\left(\frac{3\pi}{2}\right) = 0$ and $\sin\left(\frac{3\pi}{2}\right) = -1$. Therefore, we obtain that the product is

$$36\left(\cos\left(\frac{3\pi}{2}\right) + i\sin\left(\frac{3\pi}{2}\right)\right) = 36(0 + i \cdot (-1)) = -36i$$

c) For the quotient, we use the subtraction formula (21.8).

$$\frac{32(\cos(\frac{\pi}{4}) + i\sin(\frac{\pi}{4}))}{8(\cos(\frac{7\pi}{12}) + i\sin(\frac{7\pi}{12}))} = \frac{32}{8} \left(\cos\left(\frac{\pi}{4} - \frac{7\pi}{12}\right) + i\sin\left(\frac{\pi}{4} - \frac{7\pi}{12}\right) \right)$$

Now, the difference in the argument of cos and sin is given by

$$\frac{\pi}{4} - \frac{7\pi}{12} = \frac{3\pi - 7\pi}{12} = \frac{-4\pi}{12} = \frac{-\pi}{3},$$

and $\cos\left(-\frac{\pi}{3}\right) = \cos\left(\frac{\pi}{3}\right) = \frac{1}{2}$ and $\sin\left(-\frac{\pi}{3}\right) = -\sin\left(\frac{\pi}{3}\right) = -\frac{\sqrt{3}}{2}$. With this, we obtain

$$\begin{aligned} \frac{32(\cos(\frac{\pi}{4}) + i\sin(\frac{\pi}{4}))}{8(\cos(\frac{7\pi}{12}) + i\sin(\frac{7\pi}{12}))} &= 4\left(\cos\left(\frac{-\pi}{3}\right) + i\sin\left(\frac{-\pi}{3}\right)\right) \\ &= 4 \cdot \left(\frac{1}{2} - i\frac{\sqrt{3}}{2}\right) = 2 - 2\sqrt{3} \cdot i \end{aligned}$$

d) Finally, we calculate

$$\frac{4(\cos(203^\circ) + i\sin(203^\circ))}{6(\cos(74^\circ) + i\sin(74^\circ))} = \frac{2}{3} \cdot (\cos(129^\circ) + i\sin(129^\circ)).$$

Since we do not have exact values of cos and sin for the angle 129° , we approximate the complex number in standard form with the calculator.

$$\begin{aligned} \frac{2}{3} \cdot (\cos(129^\circ) + i\sin(129^\circ)) &= \frac{2}{3} \cdot \cos(129^\circ) + i \cdot \frac{2}{3} \cdot \sin(129^\circ) \\ &\approx -0.420 + 0.518 \cdot i \end{aligned}$$

Note that here we approximated the solution to the nearest thousandth. \square

21.3 Exercises

Exercise 21.1. Plot the complex numbers in the complex plane.

$$\begin{array}{llllll} \text{a) } 4 + 2i & \text{b) } -3 - 5i & \text{c) } 6 - 2i & \text{d) } -5 + i & \text{e) } -2i \\ \text{f) } \sqrt{2} - \sqrt{2}i & \text{g) } 7 & \text{h) } i & \text{i) } 0 & \text{j) } 2i - \sqrt{3} \end{array}$$

Exercise 21.2. Add, subtract, multiply, and divide, as indicated.

$$\begin{array}{ll} \text{a) } (5 - 2i) + (-2 + 6i) & \text{b) } (-9 - i) - (5 - 3i) \\ \text{c) } (3 + 2i) \cdot (4 + 3i) & \text{d) } (-2 - i) \cdot (-1 + 4i) \\ \text{e) } \frac{2+3i}{2+i} & \text{f) } (5 + 5i) \div (2 - 4i) \end{array}$$

Exercise 21.3. Find the absolute value $|a + bi|$ of the given complex number, and simplify your answer as much as possible.

$$\begin{array}{llll} \text{a) } |4 + 3i| & \text{b) } |1 - 2i| & \text{c) } |-3i| & \text{d) } |-2 - 6i| \\ \text{e) } |\sqrt{8} - i| & \text{f) } |-2\sqrt{3} - 2i| & \text{g) } |-5| & \text{h) } |-\sqrt{17} + 4\sqrt{2}i| \end{array}$$

Exercise 21.4. Convert the complex number into polar form $r(\cos(\theta) + i \sin(\theta))$.

$$\begin{array}{llll} \text{a) } 2 + 2i & \text{b) } 4\sqrt{3} + 4i & \text{c) } 3 - 2i & \text{d) } -5 + 5i \\ \text{e) } 4 - 3i & \text{f) } -4 + 3i & \text{g) } -\sqrt{5} - \sqrt{15}i & \text{h) } \sqrt{7} - \sqrt{21}i \\ \text{i) } -5 - 12i & \text{j) } 6i & \text{k) } -10 & \text{l) } -\sqrt{3} + 3i \end{array}$$

Exercise 21.5. Convert the complex number into the standard form $a + bi$.

$$\begin{array}{ll} \text{a) } 6(\cos(134^\circ) + i \sin(134^\circ)) & \text{b) } \frac{1}{2}(\cos(\frac{\pi}{17}) + i \sin(\frac{\pi}{17})) \\ \text{c) } 2(\cos(270^\circ) + i \sin(270^\circ)) & \text{d) } \cos(\frac{\pi}{6}) + i \sin(\frac{\pi}{6}) \\ \text{e) } 10(\cos(\frac{7\pi}{6}) + i \sin(\frac{7\pi}{6})) & \text{f) } 6(\cos(-\frac{5\pi}{12}) + i \sin(-\frac{5\pi}{12})) \end{array}$$

Exercise 21.6. Multiply the complex numbers and write the answer in standard form $a + bi$.

$$\begin{array}{l} \text{a) } 4(\cos(27^\circ) + i \sin(27^\circ)) \cdot 10(\cos(33^\circ) + i \sin(33^\circ)) \\ \text{b) } 7(\cos(\frac{2\pi}{9}) + i \sin(\frac{2\pi}{9})) \cdot 6(\cos(\frac{\pi}{9}) + i \sin(\frac{\pi}{9})) \\ \text{c) } (\cos(\frac{13\pi}{12}) + i \sin(\frac{13\pi}{12})) \cdot (\cos(\frac{-11\pi}{12}) + i \sin(\frac{-11\pi}{12})) \\ \text{d) } 8(\cos(\frac{3\pi}{7}) + i \sin(\frac{3\pi}{7})) \cdot 1.5(\cos(\frac{4\pi}{7}) + i \sin(\frac{4\pi}{7})) \\ \text{e) } 0.2(\cos(196^\circ) + i \sin(196^\circ)) \cdot 0.5(\cos(88^\circ) + i \sin(88^\circ)) \\ \text{f) } 4(\cos(\frac{7\pi}{8}) + i \sin(\frac{7\pi}{8})) \cdot 0.25(\cos(\frac{-5\pi}{24}) + i \sin(\frac{-5\pi}{24})) \end{array}$$

Exercise 21.7. Divide the complex numbers and write the answer in standard form $a + bi$.

a)
$$\frac{18(\cos(\frac{\pi}{2}) + i \sin(\frac{\pi}{2}))}{3(\cos(\frac{\pi}{6}) + i \sin(\frac{\pi}{6}))}$$

b)
$$\frac{10(\cos(254^\circ) + i \sin(254^\circ))}{15(\cos(164^\circ) + i \sin(164^\circ))}$$

c)
$$\frac{\sqrt{24}(\cos(\frac{11\pi}{14}) + i \sin(\frac{11\pi}{14}))}{\sqrt{6}(\cos(\frac{2\pi}{7}) + i \sin(\frac{2\pi}{7}))}$$

d)
$$\frac{\cos(\frac{8\pi}{5}) + i \sin(\frac{8\pi}{5})}{2(\cos(\frac{\pi}{10}) + i \sin(\frac{\pi}{10}))}$$

e)
$$\frac{42(\cos(\frac{7\pi}{4}) + i \sin(\frac{7\pi}{4}))}{7(\cos(\frac{5\pi}{12}) + i \sin(\frac{5\pi}{12}))}$$

f)
$$\frac{30(\cos(-175^\circ) + i \sin(-175^\circ))}{18(\cos(144^\circ) + i \sin(144^\circ))}$$

Session 22

Vectors in the plane

22.1 Introduction to vectors

There is yet another way to discuss the 2-dimensional plane, which highlights some other useful properties of the plane \mathbb{R}^2 . This is the notion of \mathbb{R}^2 as a *vector space*. We start by defining vectors in the plane.

Definition 22.1. A **geometric vector in the plane** is a geometric object in the plane \mathbb{R}^2 that is given by a **direction** and **magnitude**. We denote a vector by \vec{v} (it is written by some authors as v), its magnitude is denoted by $||\vec{v}||$, and its directional angle by θ .

Vectors are often represented by directed line segments $\vec{v} = \overrightarrow{PQ}$, where two line segments represent the same vector, if one can be moved to the other by parallel translation (without changing its direction or magnitude).

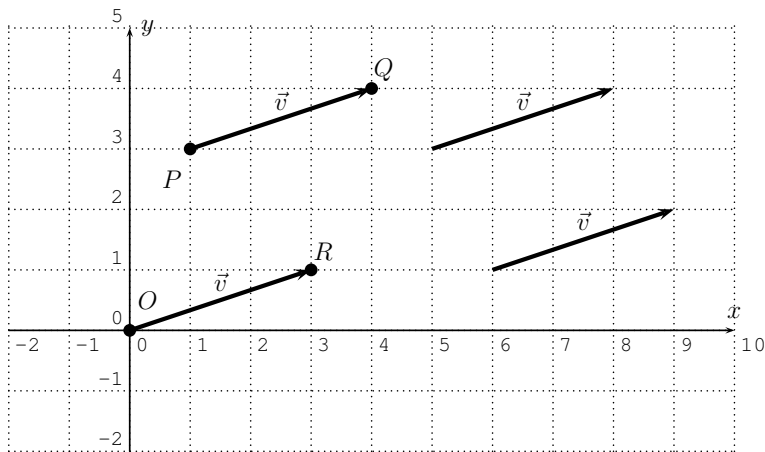

In particular, we can always represent a vector \vec{v} by \overrightarrow{OR} by arranging the starting point of \vec{v} to the origin $O(0, 0)$. If R is given in coordinates by $R(a, b)$, then we also write for $\vec{v} = \overrightarrow{OR}$,

$$\boxed{\vec{v} = \langle a, b \rangle} \quad \text{or, alternatively,} \quad \boxed{\vec{v} = \begin{bmatrix} a \\ b \end{bmatrix}}. \quad (22.1)$$

Example 22.2. Graph the vectors $\vec{v}, \vec{w}, \vec{r}, \vec{s}, \vec{t}$ in the plane, where $\vec{v} = \overrightarrow{PQ}$ with $P(6, 3)$ and $Q(4, -2)$, and

$$\vec{w} = \langle 3, -1 \rangle, \quad \vec{r} = \langle -4, -2 \rangle, \quad \vec{s} = \langle 0, 2 \rangle, \quad \vec{t} = \langle -5, 3 \rangle.$$

Solution.

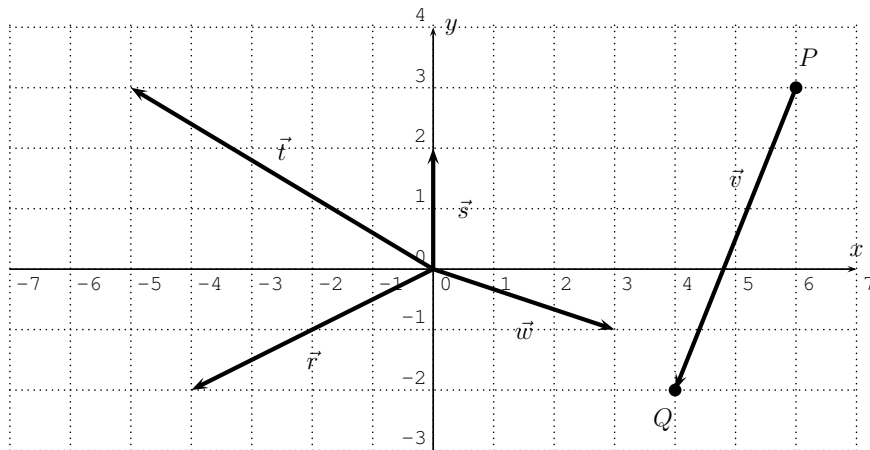

□

The formulas for the magnitude and the directional angle of a vector can be obtained precisely the same way as the absolute value and angle of a complex number. From equation (21.6) in Observation 21.6, we therefore obtain the following analogue formulas.

Observation 22.3. Let $\vec{v} = \langle a, b \rangle$ be a vector in the plane \mathbb{R}^2 . Then the magnitude and angle of \vec{v} are given by:

$$\boxed{\|\vec{v}\| = \sqrt{a^2 + b^2}} \quad \text{and} \quad \boxed{\tan(\theta) = \frac{b}{a}} \quad (22.2)$$

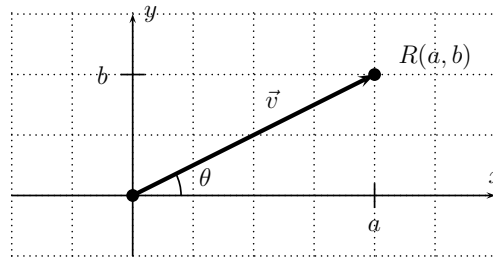

Conversely, we can recover the coordinates of a vector \vec{v} from its magnitude $\|\vec{v}\|$ and angle θ by (see equation (21.4) from page 290):

$$\vec{v} = \langle \|\vec{v}\| \cdot \cos(\theta), \|\vec{v}\| \cdot \sin(\theta) \rangle \quad (22.3)$$

Example 22.4. Find the magnitude and directional angle of the given vectors.

- a) $\langle -6, 6 \rangle$ b) $\langle 4, -3 \rangle$ c) $\langle -2\sqrt{3}, -2 \rangle$
 d) $\langle 8, 4\sqrt{5} \rangle$ e) \overrightarrow{PQ} , where $P(9, 2)$ and $Q(3, 10)$

Solution. a) We use formulas (22.2), and the calculation is in analogy with Example 21.7. The magnitude of $\vec{v} = \langle -6, 6 \rangle$ is

$$\|\vec{v}\| = \sqrt{(-6)^2 + 6^2} = \sqrt{36 + 36} = \sqrt{72} = \sqrt{36 \cdot 2} = 6\sqrt{2}.$$

The directional angle θ is given by $\tan(\theta) = \frac{6}{-6} = -1$. Now, since $\tan^{-1}(-1) = -\tan^{-1}(1) = -45^\circ$ is in the fourth quadrant, but $\vec{v} = \langle -6, 6 \rangle$ drawn at the origin $O(0, 0)$ has its endpoint in the second quadrant, we see that the angle $\theta = -45^\circ + 180^\circ = 135^\circ$.

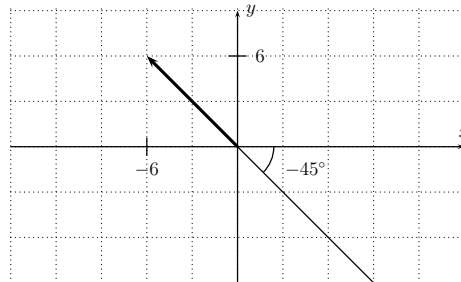

b) The magnitude of $\vec{v} = \langle 4, -3 \rangle$ is

$$\|\vec{v}\| = \sqrt{4^2 + (-3)^2} = \sqrt{16 + 9} = \sqrt{25} = 5.$$

The directional angle is given by $\tan(\theta) = \frac{-3}{4}$. Since $\tan^{-1}(\frac{-3}{4}) \approx -36.9^\circ$ is in the fourth quadrant, and $\vec{v} = \langle 4, -3 \rangle$ is in the fourth quadrant, we see that

$$\theta = \tan^{-1}\left(\frac{-3}{4}\right) \approx -36.9^\circ.$$

c) The magnitude of $\vec{v} = \langle -2\sqrt{3}, -2 \rangle$ is

$$\|\vec{v}\| = \sqrt{(-2\sqrt{3})^2 + (-2)^2} = \sqrt{4 \cdot 3 + 4} = \sqrt{12 + 4} = \sqrt{16} = 4.$$

The directional angle is given by $\tan(\theta) = \frac{-2}{-2\sqrt{3}} = \frac{1}{\sqrt{3}} = \frac{\sqrt{3}}{3}$. Now, $\tan^{-1}(\frac{\sqrt{3}}{3}) = 30^\circ = \frac{\pi}{6}$ is in the first quadrant, whereas $\vec{v} = \langle -2\sqrt{3}, -2 \rangle$ is in the third quadrant. Therefore, the angle is given by adding an additional π to the angle.

$$\theta = \pi + \frac{\pi}{6} + \frac{6\pi + \pi}{6} = \frac{7\pi}{6}.$$

d) The magnitude of $\vec{v} = \langle 8, 4\sqrt{5} \rangle$ is

$$\|\vec{v}\| = \sqrt{8^2 + (4\sqrt{5})^2} = \sqrt{64 + 16 \cdot 5} = \sqrt{64 + 80} = \sqrt{144} = 12.$$

The directional angle is given by the equation $\tan(\theta) = \frac{4\sqrt{5}}{8} = \frac{\sqrt{5}}{2}$. Since both $\tan^{-1}(\frac{\sqrt{5}}{2}) \approx 48.2^\circ$ and the endpoint of \vec{v} (represented with beginning point at the origin) are in the first quadrant, we have:

$$\theta = \tan^{-1}\left(\frac{\sqrt{5}}{2}\right) \approx 48.2^\circ.$$

e) We first need to find the vector $\vec{v} = \overrightarrow{PQ}$ in the form $\vec{v} = \langle a, b \rangle$. The vector in the plane below shows that \vec{v} is given by

$$\vec{v} = \langle 3 - 9, 10 - 2 \rangle = \langle -6, 8 \rangle$$

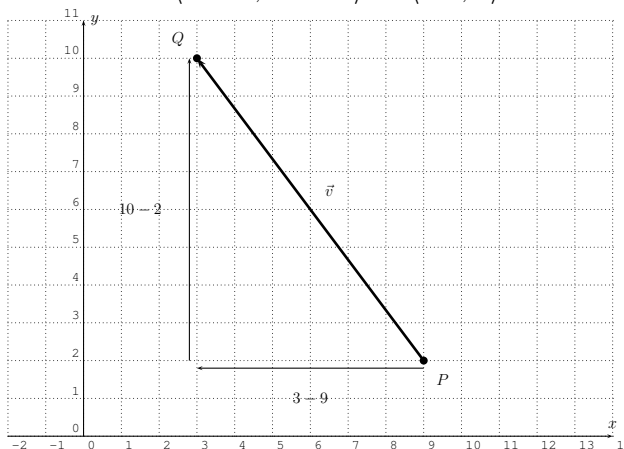

From this we calculate the magnitude to be

$$\|\vec{v}\| = \sqrt{(-6)^2 + 8^2} = \sqrt{36 + 64} = \sqrt{100} = 10.$$

The directional angle is given by $\tan(\theta) = \frac{8}{-6} = -\frac{4}{3}$. Now, $\tan^{-1}(-\frac{4}{3}) \approx -53.1^\circ$ is in quadrant IV, whereas $\vec{v} = \langle -6, 8 \rangle$ has an endpoint in quadrant II (when representing \vec{v} with starting point at the origin $O(0,0)$). Therefore, the directional angle is

$$\theta = 180^\circ + \tan^{-1}\left(-\frac{4}{3}\right) \approx 126.9^\circ$$

□

22.2 Operations on vectors

There are two basic operations on vectors, which are the *scalar multiplication* and the *vector addition*. We start with the scalar multiplication.

Definition 22.5. The **scalar multiplication** of a real number r with a vector $\vec{v} = \langle a, b \rangle$ is defined to be the vector given by multiplying r to each coordinate.

$$\boxed{r \cdot \langle a, b \rangle := \langle r \cdot a, r \cdot b \rangle} \quad (22.4)$$

We study the effect of scalar multiplication with an example.

Example 22.6. Multiply, and graph the vectors.

$$\text{a) } 4 \cdot \langle -2, 1 \rangle \quad \text{b) } (-3) \cdot \langle -6, -2 \rangle$$

Solution. a) The calculation is straightforward.

$$4 \cdot \langle -2, 1 \rangle = \langle 4 \cdot (-2), 4 \cdot 1 \rangle = \langle -8, 4 \rangle$$

The vectors are displayed below. We see, that $\langle -2, 1 \rangle$ and $\langle -8, 4 \rangle$ both have the same directional angle, and the latter stretches the former by a factor 4.

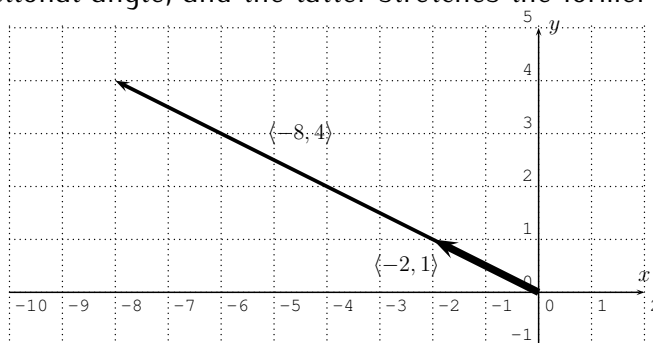

b) Algebraically, we calculate the scalar multiplication as follows:

$$(-3) \cdot \langle -6, -2 \rangle = \langle (-3) \cdot (-6), (-3) \cdot (-2) \rangle = \langle 18, 6 \rangle$$

Furthermore, graphing the vectors gives:

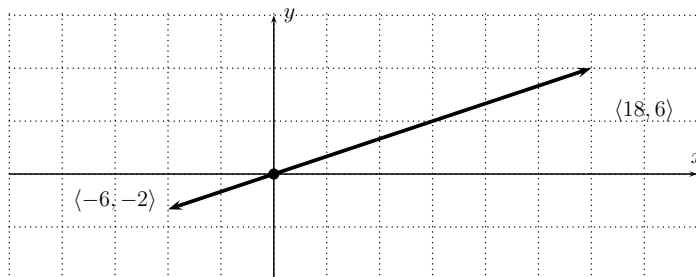

We see that the directional angle of the two vectors differs by 180° . Indeed, $\langle 18, 6 \rangle$ is obtained from $\langle -6, -2 \rangle$ by reflecting it at the origin $O(0,0)$ and then stretching the result by a factor 3. \square

We see from the above example, that scalar multiplication by a positive number c does not change the angle of the vector, but it multiplies the magnitude by c .

Observation 22.7. Let \vec{v} be a vector with magnitude $\|\vec{v}\|$ and angle $\theta_{\vec{v}}$. Then, for a positive scalar, $r > 0$, the scalar multiple $r \cdot \vec{v}$ has the same angle as \vec{v} , and a magnitude that is r times the magnitude of \vec{v} :

$$\text{for } r > 0: \quad \|r \cdot \vec{v}\| = r \cdot \|\vec{v}\| \quad \text{and} \quad \theta_{r \cdot \vec{v}} = \theta_{\vec{v}}$$

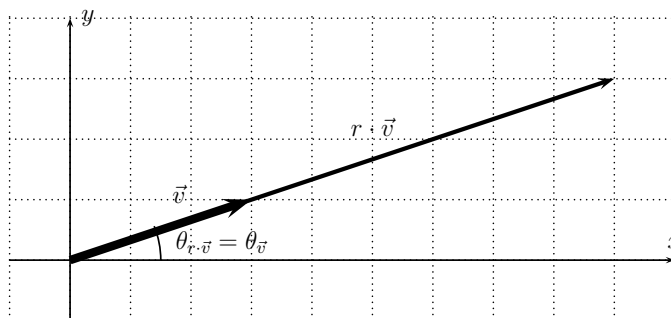

Definition 22.8. A vector \vec{u} is called a **unit vector**, if it has a magnitude of 1.

$$\vec{u} \text{ is a unit vector} \quad \iff \quad \|\vec{u}\| = 1$$

There are two special unit vectors, which are the vectors pointing in the x - and the y -direction.

$$\boxed{\vec{i} := \langle 1, 0 \rangle} \quad \text{and} \quad \boxed{\vec{j} := \langle 0, 1 \rangle} \quad (22.5)$$

Example 22.9. Find a unit vector in the direction of \vec{v} .

a) $\langle 8, 6 \rangle$ b) $\langle -2, 3\sqrt{7} \rangle$

Solution. a) Note that the magnitude of $\vec{v} = \langle 8, 6 \rangle$ is

$$\|\langle 8, 6 \rangle\| = \sqrt{8^2 + 6^2} = \sqrt{64 + 36} = \sqrt{100} = 10.$$

Therefore, if we multiply $\langle 8, 6 \rangle$ by $\frac{1}{10}$ we obtain $\frac{1}{10} \cdot \langle 8, 6 \rangle = \langle \frac{8}{10}, \frac{6}{10} \rangle = \langle \frac{4}{5}, \frac{3}{5} \rangle$, which (according to Observation 22.7 above) has the same directional angle as $\langle 8, 6 \rangle$, and has a magnitude of 1:

$$\left\| \frac{1}{10} \cdot \langle 8, 6 \rangle \right\| = \frac{1}{10} \cdot \|\langle 8, 6 \rangle\| = \frac{1}{10} \cdot 10 = 1$$

b) The magnitude of $\langle -2, 3\sqrt{7} \rangle$ is

$$\|\langle -2, 3\sqrt{7} \rangle\| = \sqrt{(-2)^2 + (3\sqrt{7})^2} = \sqrt{4 + 9 \cdot 7} = \sqrt{4 + 63} = \sqrt{67}.$$

Therefore, we have the unit vector

$$\frac{1}{\sqrt{67}} \cdot \langle -2, 3\sqrt{7} \rangle = \left\langle \frac{-2}{\sqrt{67}}, \frac{3\sqrt{7}}{\sqrt{67}} \right\rangle = \left\langle \frac{-2\sqrt{67}}{67}, \frac{3\sqrt{7}\sqrt{67}}{67} \right\rangle = \left\langle \frac{-2\sqrt{67}}{67}, \frac{3\sqrt{469}}{67} \right\rangle$$

which again has the same directional angle as $\langle -2, 3\sqrt{7} \rangle$. Now, $\frac{1}{\sqrt{67}} \cdot \langle -2, 3\sqrt{7} \rangle$ is a *unit vector*, since $\left\| \frac{1}{\sqrt{67}} \cdot \langle -2, 3\sqrt{7} \rangle \right\| = \frac{1}{\sqrt{67}} \cdot \|\langle -2, 3\sqrt{7} \rangle\| = \frac{1}{\sqrt{67}} \cdot \sqrt{67} = 1$. \square

The second operation on vectors is *vector addition*, which we discuss now.

Definition 22.10. Let $\vec{v} = \langle a, b \rangle$ and $\vec{w} = \langle c, d \rangle$ be two vectors. Then the **vector addition** $\vec{v} + \vec{w}$ is defined by component-wise addition:

$$\boxed{\langle a, b \rangle + \langle c, d \rangle := \langle a + c, b + d \rangle} \quad (22.6)$$

In terms of the plane, the vector addition corresponds to placing the vectors \vec{v} and \vec{w} as the edges of a parallelogram, so that $\vec{v} + \vec{w}$ becomes its diagonal. This is displayed below.

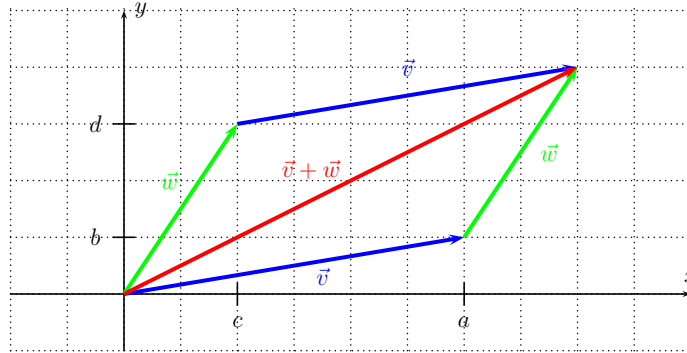

Example 22.11. Perform the vector addition and simplify as much as possible.

- a) $\langle 3, -5 \rangle + \langle 6, 4 \rangle$ b) $5 \cdot \langle -6, 2 \rangle - 7 \cdot \langle 1, -3 \rangle$ c) $4\vec{i} + 9\vec{j}$
 d) find $2\vec{v} + 3\vec{w}$ for $\vec{v} = -6\vec{i} - 4\vec{j}$ and $\vec{w} = 10\vec{i} - 7\vec{j}$
 e) find $-3\vec{v} + 5\vec{w}$ for $\vec{v} = \langle 8, \sqrt{3} \rangle$ and $\vec{w} = \langle 0, 4\sqrt{3} \rangle$

Solution. We can find the answer by direct algebraic computation.

- a) $\langle 3, -5 \rangle + \langle 6, 4 \rangle = \langle 3 + 6, -5 + 4 \rangle = \langle 9, -1 \rangle$
 b) $5 \cdot \langle -6, 2 \rangle - 7 \cdot \langle 1, -3 \rangle = \langle -30, 10 \rangle + \langle -7, 21 \rangle = \langle -37, 31 \rangle$
 c) $4\vec{i} + 9\vec{j} = 4 \cdot \langle 1, 0 \rangle + 9 \cdot \langle 0, 1 \rangle = \langle 4, 0 \rangle + \langle 0, 9 \rangle = \langle 4, 9 \rangle$

From the last calculation, we see that every vector can be written as a linear combination of the vectors \vec{i} and \vec{j} .

$$\boxed{\langle a, b \rangle = a \cdot \vec{i} + b \cdot \vec{j}} \quad (22.7)$$

We will use this equation for the next example (d). Here, $\vec{v} = -6\vec{i} - 4\vec{j} = \langle -6, -4 \rangle$ and $\vec{w} = 10\vec{i} - 7\vec{j} = \langle 10, -7 \rangle$. Therefore, we obtain:

$$\text{d) } 2\vec{v} + 3\vec{w} = 2 \cdot \langle -6, -4 \rangle + 3 \cdot \langle 10, -7 \rangle = \langle -12, -8 \rangle + \langle 30, -21 \rangle = \langle 18, -29 \rangle$$

Finally, we have:

$$\begin{aligned} \text{e) } -3\vec{v} + 5\vec{w} &= -3 \cdot \langle 8, \sqrt{3} \rangle + 5 \cdot \langle 0, 4\sqrt{3} \rangle = \langle -24, -3\sqrt{3} \rangle + \langle 0, 20\sqrt{3} \rangle \\ &= \langle -24, 17\sqrt{3} \rangle \end{aligned}$$

Note that the answer could also be written as $-3\vec{v} + 5\vec{w} = -24\vec{i} + 17\sqrt{3}\vec{j}$. \square

In many applications in the sciences, vectors play an important role, since many quantities are naturally described by vectors. Examples for this in physics include the velocity \vec{v} , acceleration \vec{a} , and the force \vec{F} applied to an object.

Example 22.12. The forces \vec{F}_1 and \vec{F}_2 are applied to an object. Find the resulting total force $\vec{F} = \vec{F}_1 + \vec{F}_2$. Determine the magnitude and directional angle of the total force \vec{F} . Approximate these values as necessary. Recall that the international system of units for force is the *newton* [$1N = 1 \frac{kg \cdot m}{s^2}$].

- a) \vec{F}_1 has magnitude 3 newtons, and angle $\theta_1 = 45^\circ$,
 \vec{F}_2 has magnitude 5 newtons, and angle $\theta_2 = 135^\circ$
- b) $\|\vec{F}_1\| = 7$ newtons, and $\theta_1 = \frac{\pi}{6}$, and
 $\|\vec{F}_2\| = 4$ newtons, and $\theta_2 = \frac{5\pi}{3}$

Solution. a) The vectors \vec{F}_1 and \vec{F}_2 are given by their magnitudes and directional angles. However, the addition of vectors (in Definition 22.10) is defined in terms of their components. Therefore, our first task is to find the vectors in component form. As was stated in equation (22.3) on page 301, the vectors are calculated by $\vec{v} = \langle \|\vec{v}\| \cdot \cos(\theta), \|\vec{v}\| \cdot \sin(\theta) \rangle$. Therefore,

$$\vec{F}_1 = \langle 3 \cdot \cos(45^\circ), 3 \cdot \sin(45^\circ) \rangle = \langle 3 \cdot \frac{\sqrt{2}}{2}, 3 \cdot \frac{\sqrt{2}}{2} \rangle = \langle \frac{3\sqrt{2}}{2}, \frac{3\sqrt{2}}{2} \rangle$$

$$\vec{F}_2 = \langle 5 \cdot \cos(135^\circ), 5 \cdot \sin(135^\circ) \rangle = \langle 5 \cdot \frac{-\sqrt{2}}{2}, 5 \cdot \frac{\sqrt{2}}{2} \rangle = \langle \frac{-5\sqrt{2}}{2}, \frac{5\sqrt{2}}{2} \rangle$$

The total force is the sum of the forces.

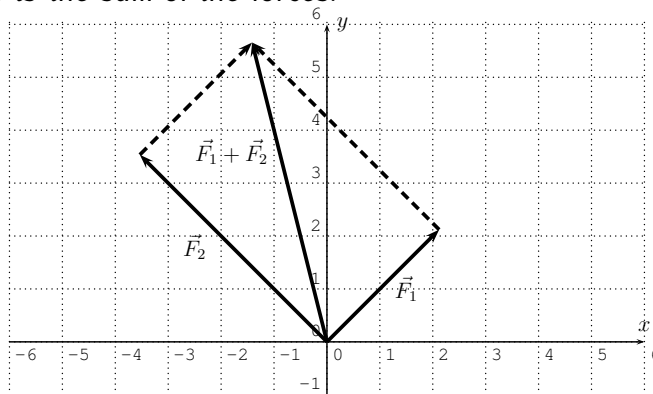

$$\vec{F} = \vec{F}_1 + \vec{F}_2 = \langle \frac{3\sqrt{2}}{2}, \frac{3\sqrt{2}}{2} \rangle + \langle \frac{-5\sqrt{2}}{2}, \frac{5\sqrt{2}}{2} \rangle$$

$$\begin{aligned}
&= \left\langle \frac{3\sqrt{2}}{2} + \frac{-5\sqrt{2}}{2}, \frac{3\sqrt{2}}{2} + \frac{5\sqrt{2}}{2} \right\rangle = \left\langle \frac{3\sqrt{2} - 5\sqrt{2}}{2}, \frac{3\sqrt{2} + 5\sqrt{2}}{2} \right\rangle \\
&= \left\langle \frac{-2\sqrt{2}}{2}, \frac{8\sqrt{2}}{2} \right\rangle = \langle -\sqrt{2}, 4\sqrt{2} \rangle
\end{aligned}$$

The total force applied in components is $\vec{F} = \langle -\sqrt{2}, 4\sqrt{2} \rangle$. It has a magnitude of $\|\vec{F}\| = \sqrt{(-\sqrt{2})^2 + (4\sqrt{2})^2} = \sqrt{2 + 16 \cdot 2} = \sqrt{34} \approx 5.83$ newton. The directional angle is given by $\tan(\theta) = \frac{4\sqrt{2}}{-\sqrt{2}} = -4$. Since $\tan^{-1}(-4) \approx -76.0^\circ$ is in quadrant IV, and $\vec{F} = \langle -\sqrt{2}, 4\sqrt{2} \rangle$ is in quadrant II, we see that the directional angle of \vec{F} is

$$\theta = 180^\circ + \tan^{-1}(-4) \approx 180^\circ - 76.0^\circ \approx 104^\circ.$$

b) We solve this example in much the same way we solved part (a). First, \vec{F}_1 and \vec{F}_2 in components is given by

$$\begin{aligned}
\vec{F}_1 &= \left\langle 7 \cdot \cos\left(\frac{\pi}{6}\right), 7 \cdot \sin\left(\frac{\pi}{6}\right) \right\rangle = \left\langle 7 \cdot \frac{\sqrt{3}}{2}, 7 \cdot \frac{1}{2} \right\rangle = \left\langle \frac{7\sqrt{3}}{2}, \frac{7}{2} \right\rangle \\
\vec{F}_2 &= \left\langle 4 \cdot \cos\left(\frac{5\pi}{3}\right), 4 \cdot \sin\left(\frac{5\pi}{3}\right) \right\rangle = \left\langle 4 \cdot \frac{1}{2}, 4 \cdot \frac{-\sqrt{3}}{2} \right\rangle = \langle 2, -2\sqrt{3} \rangle
\end{aligned}$$

The total force is therefore:

$$\begin{aligned}
\vec{F} &= \vec{F}_1 + \vec{F}_2 = \left\langle \frac{7\sqrt{3}}{2}, \frac{7}{2} \right\rangle + \langle 2, -2\sqrt{3} \rangle = \left\langle \frac{7\sqrt{3}}{2} + 2, \frac{7}{2} - 2\sqrt{3} \right\rangle \\
&\approx \langle 8.06, 0.04 \rangle
\end{aligned}$$

The magnitude is approximately

$$\|\vec{F}\| \approx \sqrt{(8.06)^2 + (0.04)^2} \approx 8.06 \text{ newton.}$$

The directional angle is given by $\tan(\theta) \approx \frac{0.04}{8.06}$. Since \vec{F} is in quadrant I, we see that $\theta \approx \tan^{-1}\left(\frac{0.04}{8.06}\right) \approx 0.3^\circ$. \square

Remark 22.13. There is an abstract notion of a *vector space*. Although we do not use this structure for any further computations, we will state its definition. A **vector space** is a set V , with the following structures and properties. The elements of V are called vectors, denoted by the usual symbol \vec{v} . For any vectors \vec{v}

and \vec{w} there is a vector $\vec{v} + \vec{w}$, called the vector addition. For any real number r and vector \vec{v} , there is a vector $r \cdot \vec{v}$ called the scalar product. These operations have to satisfy the following properties.

Associativity:	$(\vec{u} + \vec{v}) + \vec{w} = \vec{u} + (\vec{v} + \vec{w})$
Commutativity:	$\vec{v} + \vec{w} = \vec{w} + \vec{v}$
Zero element:	there is a vector \vec{o} such that $\vec{o} + \vec{v} = \vec{v}$ and $\vec{v} + \vec{o} = \vec{v}$ for every vector \vec{v}
Negative element:	for every \vec{v} there is a vector $-\vec{v}$ such that $\vec{v} + (-\vec{v}) = \vec{o}$ and $(-\vec{v}) + \vec{v} = \vec{o}$
Distributivity (1):	$r \cdot (\vec{v} + \vec{w}) = r \cdot \vec{v} + r \cdot \vec{w}$
Distributivity (2):	$(r + s) \cdot \vec{v} = r \cdot \vec{v} + s \cdot \vec{v}$
Scalar compatibility:	$(r \cdot s) \cdot \vec{v} = r \cdot (s \cdot \vec{v})$
Identity:	$1 \cdot \vec{v} = \vec{v}$

A very important example of a vector space is the 2-dimensional plane $V = \mathbb{R}^2$ as it was discussed in this chapter.

22.3 Exercises

Exercise 22.1. Graph the vectors in the plane.

- a) \overrightarrow{PQ} with $P(2, 1)$ and $Q(4, 7)$ b) \overrightarrow{PQ} with $P(-3, 3)$ and $Q(-5, -4)$
 c) \overrightarrow{PQ} with $P(0, -4)$ and $Q(6, 0)$ d) $\langle -2, 4 \rangle$
 e) $\langle -3, -3 \rangle$ f) $\langle 5, 5\sqrt{2} \rangle$

Exercise 22.2. Find the magnitude and directional angle of the vector.

- a) $\langle 6, 8 \rangle$ b) $\langle -2, 5 \rangle$ c) $\langle -4, -4 \rangle$
 d) $\langle 3, -3 \rangle$ e) $\langle 2, -2 \rangle$ f) $\langle 4\sqrt{3}, 4 \rangle$
 g) $\langle -\sqrt{3}, -1 \rangle$ h) $\langle -4, 4\sqrt{3} \rangle$ i) $\langle -2\sqrt{3}, -2 \rangle$

- j) \overrightarrow{PQ} , where $P(3, 1)$ and $Q(7, 4)$
 k) \overrightarrow{PQ} , where $P(4, -2)$ and $Q(-5, 7)$

Exercise 22.3. Perform the operation on the vectors.

- a) $5 \cdot \langle 3, 2 \rangle$ b) $2 \cdot \langle -1, 4 \rangle$
 c) $(-10) \cdot \langle -\frac{3}{2}, -\frac{7}{5} \rangle$ d) $\langle 2, 3 \rangle + \langle 6, 1 \rangle$
 e) $\langle 5, -4 \rangle - \langle -8, -9 \rangle$ f) $3 \cdot \langle 5, 3 \rangle + 4 \cdot \langle 2, 8 \rangle$
 g) $(-2)\langle -5, -4 \rangle - 6\langle -1, -2 \rangle$ h) $\frac{2}{3}\langle -3, 6 \rangle - \frac{7}{5}\langle 10, -15 \rangle$
 i) $\sqrt{2} \cdot \langle \frac{\sqrt{8}}{6}, \frac{-5\sqrt{2}}{12} \rangle - 2\langle \frac{2}{3}, \frac{5}{3} \rangle$ j) $6\vec{i} - 4\vec{j}$
 k) $-5\vec{i} + \vec{j} + 3\vec{i}$ l) $3 \cdot \langle -4, 2 \rangle - 8\vec{j} + 12\vec{i}$

- m) find $4\vec{v} + 7\vec{w}$ for $\vec{v} = \langle 2, 3 \rangle$ and $\vec{w} = \langle 5, 1\sqrt{3} \rangle$
 n) find $\vec{v} - 2\vec{w}$ for $\vec{v} = \langle -11, -6 \rangle$ and $\vec{w} = \langle -3, 2 \rangle$
 o) find $3\vec{v} - \vec{w}$ for $\vec{v} = -4\vec{i} + 7\vec{j}$ and $\vec{w} = 6\vec{i} + \vec{j}$
 p) find $-\vec{v} - \sqrt{5}\vec{w}$ for $\vec{v} = 5\vec{j}$ and $\vec{w} = -8\vec{i} + \sqrt{5}\vec{j}$

Exercise 22.4. Find a unit vector in the direction of the given vector.

- a) $\langle 8, -6 \rangle$ b) $\langle -3, -\sqrt{7} \rangle$ c) $\langle 9, 2 \rangle$
 d) $\langle -\sqrt{5}, \sqrt{31} \rangle$ e) $\langle 5\sqrt{2}, 3\sqrt{10} \rangle$ f) $\langle 0, -\frac{3}{5} \rangle$

Exercise 22.5. The vectors \vec{v}_1 and \vec{v}_2 below are being added. Find the approximate magnitude and directional angle of sum $\vec{v} = \vec{v}_1 + \vec{v}_2$ (see Example 22.12).

- a) $\|\vec{v}_1\| = 6$, and $\theta_1 = 60^\circ$, and
 $\|\vec{v}_2\| = 2$, and $\theta_2 = 180^\circ$
 b) $\|\vec{v}_1\| = 3.7$, and $\theta_1 = 92^\circ$, and
 $\|\vec{v}_2\| = 2.2$, and $\theta_2 = 253^\circ$
 c) $\|\vec{v}_1\| = 8$, and $\theta_1 = \frac{3\pi}{4}$, and
 $\|\vec{v}_2\| = 8\sqrt{2}$, and $\theta_2 = \frac{3\pi}{2}$

Session 23

Sequences and series

23.1 Introduction to sequences and series

Definition 23.1. A **sequence** is an ordered list of numbers. We write a sequence in order as follows:

$$a_1, a_2, a_3, a_4, \dots$$

In short we write the above sequence as $\{a_n\}$ or $\{a_n\}_{n \geq 1}$.

You might wonder how this topic fits into the general theme of functions. We can alternatively define a sequence a to be a function $a : \mathbb{N} \rightarrow R$, where the domain is all natural numbers, and the range R is a subset of the real or complex numbers. We write the n th term of the sequence as $a_n = a(n)$.

Example 23.2. Here are some examples of sequences.

- a) 4, 6, 8, 10, 12, 14, 16, 18, ...
- b) 1, 3, 9, 27, 81, 243, ...
- c) +5, -5, +5, -5, +5, -5, ...
- d) 1, 1, 2, 3, 5, 8, 13, 21, 34, 55, ...
- e) 5, 8, -12, 4, 5.3, 7, -3, $\sqrt{2}$, 18, $\frac{2}{3}$, 9, ...

For many of these sequences we can find rules that describe how to obtain the individual terms. For example, in (a), we always add the fixed number 2 to the previous number to obtain the next, starting from the first term 4. This

is an example of an *arithmetic sequence*, and we will study those in more detail in section 23.2 below.

In (b), we start with the first element 1 and multiply by the fixed number 3 to obtain the next term. This is an example of a *geometric sequence*, and we will study those in more detail in section 24 below.

The sequence in (c) alternates between +5 and -5, starting from +5. Note, that we can get from one term to the next by multiplying (-1) to the term. Therefore, this is another example of a geometric sequence.

The sequence in (d) is called the **Fibonacci sequence**. In the Fibonacci sequence, each term is calculated by adding the previous two terms, starting with the first two terms 1 and 1:

$$1 + 1 = 2, \quad 1 + 2 = 3, \quad 2 + 3 = 5, \quad 3 + 5 = 8, \quad 5 + 8 = 13, \quad \dots$$

Finally, the sequence in (e) does not seem to have any obvious rule by which the terms are generated.

In many cases, the sequence is given by a formula for the n th term a_n .

Example 23.3. Consider the sequence $\{a_n\}$ with $a_n = 4n + 3$. We can calculate the individual terms of this sequence:

$$\begin{aligned} \text{first term:} & \quad a_1 = 4 \cdot 1 + 3 = 7, \\ \text{second term:} & \quad a_2 = 4 \cdot 2 + 3 = 11, \\ \text{third term:} & \quad a_3 = 4 \cdot 3 + 3 = 15, \\ \text{fourth term:} & \quad a_4 = 4 \cdot 4 + 3 = 19, \\ \text{fifth term:} & \quad a_5 = 4 \cdot 5 + 3 = 23 \\ & \quad \vdots \end{aligned}$$

Thus, the sequence is: 7, 11, 15, 19, 23, 27, 31, 35, ...

Furthermore, from the formula, we can directly calculate a higher term, for example the 200th term is given by:

$$\text{200th term:} \quad a_{200} = 4 \cdot 200 + 3 = 803$$

Example 23.4. Find the first 6 terms of each sequence.

$$\text{a) } a_n = n^2 \quad \text{b) } a_n = \frac{n}{n+1} \quad \text{c) } a_n = (-1)^n \quad \text{d) } a_n = (-1)^{n+1} \cdot 2^n$$

Solution. a) We can easily calculate the first 6 terms of $a_n = n^2$ directly:

$$1, 4, 9, 16, 25, 36, \dots$$

We can also use the calculator to produce the terms of a sequence. To this end, we switch the calculator from function mode to sequence mode in the mode menu (press):

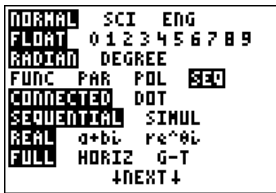

To enter the sequence, we need to use the LIST menu (press and then) , then go to the OPS menu (press) , and use the fifth item (press):

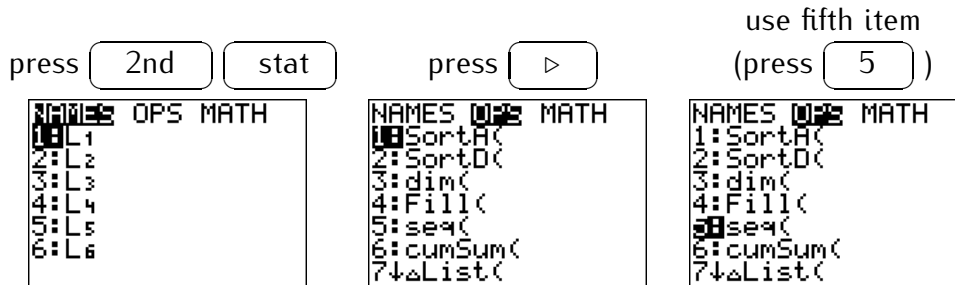

For the sequence, we need to specify four pieces of information, where the index n can be entered via the key.

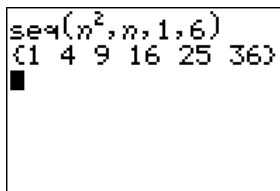

1st entry is the given formula for $a_n = n^2$

2nd entry is the index n of the sequence a_n

3rd and 4th entries are the first and last index 1 and 6 of the wanted sequence, here: a_1, \dots, a_6

Alternatively, we can enter the function in the menu, starting from the first index $n = 1$, and with n th term given by $a_n = n^2$. The values of the sequence are displayed in the table window (press

and ).

<pre> Plot1 Plot2 Plot3 nMin=1 u(n)≡n² u(nMin)≡■ v(n)= v(nMin)= w(n)= </pre>	<table border="1"> <thead> <tr> <th>n</th> <th>u(n)</th> </tr> </thead> <tbody> <tr> <td>1</td> <td>1</td> </tr> <tr> <td>2</td> <td>4</td> </tr> <tr> <td>3</td> <td>9</td> </tr> <tr> <td>4</td> <td>16</td> </tr> <tr> <td>5</td> <td>25</td> </tr> <tr> <td>6</td> <td>36</td> </tr> <tr> <td>7</td> <td>49</td> </tr> </tbody> </table>	n	u(n)	1	1	2	4	3	9	4	16	5	25	6	36	7	49
n	u(n)																
1	1																
2	4																
3	9																
4	16																
5	25																
6	36																
7	49																

b) We calculate the lowest terms of $a_n = \frac{n}{n+1}$:

$$a_1 = \frac{1}{1+1} = \frac{1}{2}, \quad a_2 = \frac{2}{2+1} = \frac{2}{3}, \quad a_3 = \frac{3}{3+1} = \frac{3}{4}, \quad \dots$$

Identifying the pattern, we can simply write a_1, \dots, a_6 as follows:

$$\frac{1}{2}, \frac{2}{3}, \frac{3}{4}, \frac{4}{5}, \frac{5}{6}, \frac{6}{7}$$

We can also use the calculator to find the sequence:

```

seq(n/(n+1),n,1▶
(.5 .6666666667▶

```

Note 23.5. Fractions can be displayed with the calculator by adding “Frac” to it from the MATH menu (using  and the top item). For example, the fraction $\frac{2}{7}$ is displayed below without approximation.

<pre> 2/7 .2857142857 </pre>	<pre> MATH NUM CPX PRB 1▶Frac 2▶Dec 3▶ 4▶< 5▶*J 6▶fMin(7▶fMax(</pre>	<pre> 2/7 .2857142857 2/7▶Frac 2/7 </pre>
------------------------------	---	---

Adding “Frac” to the sequence displays it more appropriately as a sequence of fractions.

<pre> seq(n/(n+1),n,1▶ (.5 .6666666667▶ (1),n,1,6)▶Frac </pre>	<pre> seq(n/(n+1),n,1▶ (.5 .6666666667▶ seq(n/(n+1),n,1▶ {1/2 2/3 3/4 4/5 5/6 6/7} </pre>
--	---

c) Since $(-1)^n$ is $+1$ for even n , but is -1 for odd n , the sequence $a_n = (-1)^n$ is:

$$-1, +1, -1, +1, -1, +1$$

d) Similar to part (c), $(-1)^{n+1}$ is -1 for even n , and is $+1$ for odd n . This, together with the calculation $2^1 = 2, 2^2 = 4, 2^3 = 8, 2^4 = 16$, etc., we get the first six terms of the sequence:

$$+2, -4, +8, -16, +32, -64$$

□

Another way to describe a sequence is by giving a *recursive* formula for the n th term a_n in terms of the lower terms. Here are some examples.

Example 23.6. Find the first 6 terms in the sequence described below.

- a) $a_1 = 4$, and $a_n = a_{n-1} + 5$ for $n > 1$
- b) $a_1 = 3$, and $a_n = 2 \cdot a_{n-1}$ for $n > 1$
- c) $a_1 = 1, a_2 = 1$, and $a_n = a_{n-1} + a_{n-2}$ for $n > 2$

Solution. a) The first term is explicitly given as $a_1 = 4$. Then, we can calculate the following terms via $a_n = a_{n-1} + 5$:

$$\begin{aligned} a_2 &= a_1 + 5 = 4 + 5 = 9 \\ a_3 &= a_2 + 5 = 9 + 5 = 14 \\ a_4 &= a_3 + 5 = 14 + 5 = 19 \\ a_5 &= a_4 + 5 = 19 + 5 = 24 \\ &\vdots \end{aligned}$$

b) We have $a_1 = 3$, and calculate $a_2 = 2 \cdot a_1 = 2 \cdot 3 = 6$, $a_3 = 2 \cdot a_2 = 2 \cdot 6 = 12$, $a_4 = 2 \cdot a_3 = 2 \cdot 12 = 24$, etc. We see that the effect of the recursive relation $a_n = 2 \cdot a_{n-1}$ is to double the previous number. The sequence is:

$$3, 6, 12, 24, 48, 96, 192, \dots$$

c) Starting from $a_1 = 1$, and $a_2 = 1$, we can calculate the higher terms:

$$\begin{aligned} a_3 &= a_1 + a_2 = 1 + 1 = 2 \\ a_4 &= a_2 + a_3 = 1 + 2 = 3 \end{aligned}$$

$$\begin{aligned} a_5 &= a_3 + a_4 = 2 + 3 = 5 \\ a_6 &= a_4 + a_5 = 3 + 5 = 8 \\ &\vdots \end{aligned}$$

Studying the sequence for a short while, we see that this is precisely the Fibonacci sequence from example 23.2(d). \square

Note 23.7. There is no specific reason for using the indexing variable n in the sequence $\{a_n\}$. Indeed, we may use as well any other variable. For example, if the sequence $\{a_n\}_{n \geq 1}$ is given by the formula $a_n = 4n + 3$, then we can also write this as $a_k = 4k + 3$ or $a_i = 4i + 3$. In particular, the sequences $\{a_n\}_{n \geq 1} = \{a_k\}_{k \geq 1} = \{a_i\}_{i \geq 1} = \{a_j\}_{j \geq 1}$ are all identical as sequences.

We will be concerned with the task of adding terms in a sequence, such as $a_1 + a_2 + a_3 + \cdots + a_k$, for which we will use a standard summation notation.

Definition 23.8. A **series** is a sum of terms in a sequence. We denote the sum of the first k terms in a sequence with the following notation:

$$\sum_{i=1}^k a_i = a_1 + a_2 + \cdots + a_k \quad (23.1)$$

The summation symbol “ \sum ” comes from the greek letter Σ , pronounced “sigma,” which is the greek letter for “S.”

More generally, we denote the sum from the j th to the k th term (where $j \leq k$) in a sequence with the following notion:

$$\sum_{i=j}^k a_i = a_j + a_{j+1} + \cdots + a_k$$

Furthermore, the term $\sum_{i=j}^k a_i$ is sometimes also written in the form $\sum_{i=j}^k a_i$.

Example 23.9. Find the sum.

a) $\sum_{i=1}^4 a_i$, for $a_i = 7i + 3$

b) $\sum_{j=1}^6 a_j$, for $a_n = (-2)^n$

c) $\sum_{k=1}^5 (4 + k^2)$

Solution. a) The first four terms a_1, a_2, a_3, a_4 of the sequence $\{a_i\}_{i \geq 1}$ are:

$$10, 17, 24, 31$$

The sum is therefore:

$$\sum_{i=1}^4 a_i = a_1 + a_2 + a_3 + a_4 = 10 + 17 + 24 + 31 = 82$$

We may also find the answer with the calculator. Before entering the sequence (via) as in example 23.4(a) above), we have to put a sum symbol in the LIST menu and MATH submenu (with):

<p>press <input type="button" value="2nd"/></p> <p><input type="button" value="stat"/> <input type="button" value="◀"/></p> <pre>NAMES OPS MATH 1:min(2:max(3:mean(4:median(5:sum(6:Prod(7:stdDev(</pre>	<p>press <input type="button" value="5"/></p> <pre>sum(█</pre>	<p>enter the sum and seq.</p> <p>sum(seq(7n+3,n,1,4))</p> <pre>sum(seq(7n+3,n,1,4) 82</pre>
--	--	---

b) The first six terms of $\{a_n\}$ with $a_n = (-2)^n$ are:

$$(-2)^1 = -2, (-2)^2 = 4, (-2)^3 = -8, (-2)^4 = 16, (-2)^5 = -32, (-2)^6 = 64$$

We calculate $\sum_{j=1}^6 a_j$ by adding these first six terms. (Note that the sum is independent of the index j appearing in the sum $\sum_{j=1}^6 a_j$, which we could as well replace by any other index $\sum_{j=1}^6 a_j = \sum_{k=1}^6 a_k$, etc.) We get:

$$\begin{aligned} \sum_{j=1}^6 a_j &= a_1 + a_2 + a_3 + a_4 + a_5 + a_6 \\ &= (-2) + 4 + (-8) + 16 + (-32) + 64 = 42 \end{aligned}$$

c) For the sum $\sum_{k=1}^5 (4 + k^2)$ we need to add the first four terms of the sequence $a_k = 4 + k^2$. Calculating and adding the terms of this sequence, we obtain the sum:

$$\sum_{k=1}^5 (4 + k^2) = (4 + 1^2) + (4 + 2^2) + (4 + 3^2) + (4 + 4^2) + (4 + 5^2)$$

$$\begin{aligned}
 &= (4 + 1) + (4 + 4) + (4 + 9) + (4 + 16) + (4 + 25) \\
 &= 5 + 8 + 13 + 20 + 29 \\
 &= 75
 \end{aligned}$$

This answer can of course also be confirmed with the calculator (after replacing the index k with n) as we did in part (a). \square

23.2 The arithmetic sequence

We have already encountered examples of arithmetic sequences in the previous section. An arithmetic sequence is a sequence for which we add a constant number to get from one term to the next, for example:

$$8, \overset{\curvearrowright}{\underset{+3}{\rightarrow}} 11, \overset{\curvearrowright}{\underset{+3}{\rightarrow}} 14, \overset{\curvearrowright}{\underset{+3}{\rightarrow}} 17, \overset{\curvearrowright}{\underset{+3}{\rightarrow}} 20, \overset{\curvearrowright}{\underset{+3}{\rightarrow}} 23, \dots$$

Definition 23.10. A sequence $\{a_n\}$ is called an **arithmetic sequence** if any two consecutive terms have a *common difference* d . The arithmetic sequence is determined by d and the first value a_1 . This can be written recursively as:

$$a_n = a_{n-1} + d \quad \text{for } n \geq 2$$

Alternatively, we have the general formula for the n th term of the arithmetic sequence:

$$\boxed{a_n = a_1 + d \cdot (n - 1)} \quad (23.2)$$

Example 23.11. Determine if the sequence is an arithmetic sequence. If so, then find the general formula for a_n in the form of equation (23.2).

- a) 7, 13, 19, 25, 31, ... b) 13, 9, 5, 1, -3, -7, ...
 c) 10, 13, 16, 20, 23, ... d) $a_n = 8 \cdot n + 3$

Solution. a) Calculating the difference between two consecutive terms always gives the same answer $13 - 7 = 6$, $19 - 13 = 6$, $25 - 19 = 6$, etc. Therefore the common difference $d = 6$, which shows that this is an arithmetic sequence. Furthermore, the first term is $a_1 = 7$, so that the general formula for the n th term is $a_n = 7 + 6 \cdot (n - 1)$.

b) One checks that the common difference is $9 - 13 = -4$, $5 - 9 = -4$, etc., so that this is an arithmetic sequence with $d = -4$. Since $a_1 = 13$, the general term is $a_n = 13 - 4 \cdot (n - 1)$.

c) We have $13 - 10 = 3$, but $20 - 16 = 4$, so that this is *not* an arithmetic sequence.

d) If we write out the first couple of terms of $a_n = 8n + 3$, we get the sequence:

$$11, 19, 27, 35, 43, 51, \dots$$

From this it seems reasonable to suspect that this is an arithmetic sequence with common difference $d = 8$ and first term $a_1 = 11$. The general term of such an arithmetic sequence is

$$a_1 + d(n - 1) = 11 + 8(n - 1) = 11 + 8n - 8 = 8n + 3 = a_n.$$

This shows that $a_n = 8n + 3 = 11 + 8(n - 1)$ is an arithmetic sequence. \square

Example 23.12. Find the general formula of an arithmetic sequence with the given property.

- a) $d = 12$, and $a_6 = 68$
- b) $a_1 = -5$, and $a_9 = 27$
- c) $a_5 = 38$, and $a_{16} = 115$

Solution. a) According to equation (23.2) the general term is $a_n = a_1 + d(n - 1)$. We know that $d = 12$, so that we only need to find a_1 . Plugging $a_6 = 68$ into $a_n = a_1 + d(n - 1)$, we may solve for a_1 :

$$68 = a_6 = a_1 + 12 \cdot (6 - 1) = a_1 + 12 \cdot 5 = a_1 + 60 \xrightarrow{(-60)} a_1 = 68 - 60 = 8$$

The n th term is therefore, $a_n = 8 + 12 \cdot (n - 1)$.

b) In this case, we are given $a_1 = -5$, but we still need to find the common difference d . Plugging $a_9 = 27$ into $a_n = a_1 + d(n - 1)$, we obtain

$$\begin{aligned} 27 = a_9 = -5 + d \cdot (9 - 1) = -5 + 8d &\xrightarrow{(+5)} 32 = 8d \\ &\xrightarrow{(\div 8)} 4 = d \end{aligned}$$

The n th term is therefore, $a_n = -5 + 4 \cdot (n - 1)$.

c) In this case we neither have a_1 nor d . However, the two conditions $a_5 = 38$ and $a_{16} = 115$ give two equations in the two unknowns a_1 and d .

$$\begin{cases} 38 = a_5 = a_1 + d(5 - 1) \\ 115 = a_{16} = a_1 + d(16 - 1) \end{cases} \implies \begin{cases} 38 = a_1 + 4 \cdot d \\ 115 = a_1 + 15 \cdot d \end{cases}$$

To solve this system of equations, we need to recall the methods for doing so. One convenient method is the addition/subtraction method. For this, we subtract the top from the bottom equation:

$$\begin{array}{r} 115 = a_1 + 15 \cdot d \\ -(38 = a_1 + 4 \cdot d) \\ \hline 77 = + 11 \cdot d \end{array} \quad \xRightarrow{(\div 11)} \quad 7 = d$$

Plugging $d = 7$ into either of the two equations gives a_1 . We plug it into the first equation $38 = a_1 + 4d$:

$$38 = a_1 + 4 \cdot 7 \quad \implies \quad 38 = a_1 + 28 \quad \xRightarrow{(-28)} \quad 10 = a_1$$

Therefore, the n th term is given by $a_n = 10 + 7 \cdot (n - 1)$. □

We can sum the first k terms of an arithmetic sequence using a trick, which, according to lore, was found by the German mathematician Carl Friedrich Gauss when he was a child at school.

Example 23.13. Find the sum of the first 100 integers, starting from 1. In other words, we want to find the sum of $1 + 2 + 3 + \cdots + 99 + 100$. First, note that the sequence $1, 2, 3, \dots$ is an arithmetic sequence. The main idea for solving this problem is a trick, which will indeed work for any arithmetic sequence:

Let $S = 1 + 2 + 3 + \cdots + 98 + 99 + 100$ be what we want to find. Note that

$$2S = \begin{array}{cccccccccccc} 1 & + & 2 & + & 3 & \cdots & + & 98 & + & 99 & + & 100 \\ + & 100 & + & 99 & + & 98 & \cdots & + & 3 & + & 2 & + & 1 \end{array} .$$

Note that the second line is also S but is added in the reverse order. Adding vertically we see then that

$$2S = 101 + 101 + 101 + \cdots + 101 + 101 + 101,$$

where there are 100 terms on the right hand side. So

$$2S = 100 \cdot 101 \text{ and therefore } S = \frac{100 \cdot 101}{2} = 5050.$$

The previous example generalizes to the more general setting starting with an arbitrary arithmetic sequence.

Observation 23.14. Let $\{a_n\}$ be an arithmetic sequence, whose n th term is given by the formula $a_n = a_1 + d(n-1)$. Then, the sum $a_1 + a_2 + \cdots + a_{k-1} + a_k$ is given by adding $(a_1 + a_k)$ precisely $\frac{k}{2}$ times:

$$\boxed{\sum_{i=1}^k a_i = \frac{k}{2} \cdot (a_1 + a_k)} \quad (23.3)$$

In order to remember the formula above, it may be convenient to think of the right hand side as $k \cdot \frac{a_1 + a_k}{2}$ (this is, k times the average of the first and the last term).

Proof. For the proof of equation (23.3), we write $S = a_1 + a_2 + \cdots + a_{k-1} + a_k$. We then add it to itself but in reverse order:

$$2S = \begin{array}{cccccccc} a_1 & + & a_2 & + & a_3 & \cdots & + & a_{k-2} & + & a_{k-1} & + & a_k \\ + & a_k & + & a_{k-1} & + & a_{k-2} & \cdots & + & a_3 & + & a_2 & + & a_1 \end{array}$$

Now note that in general $a_l + a_m = 2a_1 + d(l+m-2)$. We see that adding vertically gives

$$2S = k(2a_1 + d(k-1)) = k(a_1 + (a_1 + d(k-1))) = k(a_1 + a_k).$$

Dividing by 2 gives the desired result. □

Example 23.15. Find the value of the arithmetic series.

- Find the sum $a_1 + \cdots + a_{60}$ for the arithmetic sequence $a_n = 2 + 13(n-1)$.
- Determine the value of the sum: $\sum_{j=1}^{1001} (5 - 6j)$
- Find the sum of the first 35 terms of the sequence

$$4, 3.5, 3, 2.5, 2, 1.5, \dots$$

Solution. a) The sum is given by the formula (23.3): $\sum_{i=1}^k a_i = \frac{k}{2} \cdot (a_1 + a_k)$. Here, $k = 60$, and $a_1 = 2$ and $a_{60} = 2 + 13 \cdot (60-1) = 2 + 13 \cdot 59 = 2 + 767 = 769$. We obtain a sum of

$$a_1 + \cdots + a_{60} = \sum_{i=1}^{60} a_i = \frac{60}{2} \cdot (2 + 769) = 30 \cdot 771 = 23130.$$

We may confirm this with the calculator as described in example 23.9 (on page 316) in the previous section.

Enter:

$$\text{sum}(\text{seq}((2 + 13 \cdot (n - 1)), n, 1, 60))$$

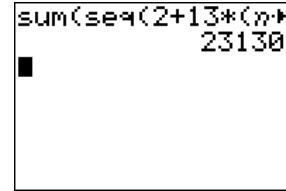

b) Again, we use the above formula $\sum_{j=1}^k a_j = \frac{k}{2} \cdot (a_1 + a_k)$, where the arithmetic sequence is given by $a_j = 5 - 6j$ and $k = 1001$. Using the values $a_1 = 5 - 6 \cdot 1 = 5 - 6 = -1$ and $a_{1001} = 5 - 6 \cdot 1001 = 5 - 6006 = -6001$, we obtain:

$$\begin{aligned} \sum_{j=1}^{1001} (5 - 6j) &= \frac{1001}{2} (a_1 + a_{1001}) = \frac{1001}{2} ((-1) + (-6001)) \\ &= \frac{1001}{2} \cdot (-6002) = 1001 \cdot (-3001) = -3004001 \end{aligned}$$

c) First note that the given sequence $4, 3.5, 3, 2.5, 2, 1.5, \dots$ is an arithmetic sequence. It is determined by the first term $a_1 = 4$ and common difference $d = -0.5$. The n th term is given by $a_n = 4 - 0.5 \cdot (n - 1)$, and summing the first $k = 35$ terms gives:

$$\sum_{i=1}^{35} a_i = \frac{35}{2} \cdot (a_1 + a_{35})$$

We see that we need to find a_{35} in the above formula:

$$a_{35} = 4 - 0.5 \cdot (35 - 1) = 4 - 0.5 \cdot 34 = 4 - 17 = -13$$

This gives a total sum of

$$\sum_{i=1}^{35} a_i = \frac{35}{2} \cdot (4 + (-13)) = \frac{35}{2} \cdot (-9) = \frac{-315}{2}.$$

The answer may be written as a fraction or also as a decimal, that is: $\sum_{i=1}^{35} a_i = \frac{-315}{2} = -157.5$. \square

23.3 Exercises

Exercise 23.1. Find the first seven terms of the sequence.

$$\begin{array}{llll} \text{a) } a_n = 3n & \text{b) } a_n = 5n + 3 & \text{c) } a_n = n^2 + 2 & \text{d) } a_n = n \\ \text{e) } a_n = (-1)^{n+1} & \text{f) } a_n = \frac{\sqrt{n+1}}{n} & \text{g) } a_k = 10^k & \text{h) } a_i = 5 + (-1)^i \end{array}$$

Exercise 23.2. Find the first six terms of the sequence.

$$\begin{array}{l} \text{a) } a_1 = 5, \quad a_n = a_{n-1} + 3 \text{ for } n \geq 2 \\ \text{b) } a_1 = 7, \quad a_n = 10 \cdot a_{n-1} \text{ for } n \geq 2 \\ \text{c) } a_1 = 1, \quad a_n = 2 \cdot a_{n-1} + 1 \text{ for } n \geq 2 \\ \text{d) } a_1 = 6, \quad a_2 = 4, \quad a_n = a_{n-1} - a_{n-2} \text{ for } n \geq 3 \end{array}$$

Exercise 23.3. Find the value of the series.

$$\begin{array}{ll} \text{a) } \sum_{n=1}^4 a_n, \quad \text{where } a_n = 5n, & \text{b) } \sum_{k=1}^5 a_k, \quad \text{where } a_k = k, \\ \text{c) } \sum_{i=1}^4 a_i, \quad \text{where } a_n = n^2, & \text{d) } \sum_{n=1}^6 (n-4), \\ \text{e) } \sum_{k=1}^3 (k^2 + 4k - 4), & \text{f) } \sum_{j=1}^4 \frac{1}{j+1}. \end{array}$$

Exercise 23.4. Is the sequence below part of an arithmetic sequence? In the case that it is part of an arithmetic sequence, find the formula for the n th term a_n in the form $a_n = a_1 + d \cdot (n - 1)$.

$$\begin{array}{ll} \text{a) } 5, 8, 11, 14, 17, \dots & \text{b) } -10, -7, -4, -1, 2, \dots \\ \text{c) } -1, 1, -1, 1, -1, 1, \dots & \text{d) } 18, 164, 310, 474, \dots \\ \text{e) } 73.4, 51.7, 30, \dots & \text{f) } 9, 3, -3, -8, -14, \dots \\ \text{g) } 4, 4, 4, 4, 4, \dots & \text{h) } -2.72, -2.82, -2.92, -3.02, -3.12, \dots \\ \text{i) } \sqrt{2}, \sqrt{5}, \sqrt{8}, \sqrt{11}, \dots & \text{j) } \frac{-3}{5}, \frac{-1}{10}, \frac{2}{5}, \dots \\ \text{k) } a_n = 4 + 5 \cdot n & \text{l) } a_j = 2 \cdot j - 5 \\ \text{m) } a_n = n^2 + 8n + 15 & \text{n) } a_k = 9 \cdot (k + 5) + 7k - 1 \end{array}$$

Exercise 23.5. Determine the general n th term a_n of an arithmetic sequence $\{a_n\}$ with the data given below.

$$\begin{array}{ll} \text{a) } d = 4, \text{ and } a_8 = 57 & \text{b) } d = -3, \text{ and } a_{99} = -70 \\ \text{c) } a_1 = 14, \text{ and } a_7 = -16 & \text{d) } a_1 = -80, \text{ and } a_5 = 224 \\ \text{e) } a_3 = 10, \text{ and } a_{14} = -23 & \text{f) } a_{20} = 2, \text{ and } a_{60} = 32 \end{array}$$

Exercise 23.6. Determine the value of the indicated term of the given arithmetic sequence.

- a) if $a_1 = 8$, and $a_{15} = 92$, find a_{19}
- b) if $d = -2$, and $a_3 = 31$, find a_{81}
- c) if $a_1 = 0$, and $a_{17} = -102$, find a_{73}
- d) if $a_7 = 128$, and $a_{37} = 38$, find a_{26}

Exercise 23.7. Determine the sum of the arithmetic sequence.

a) Find the sum $a_1 + \cdots + a_{48}$ for the arithmetic sequence $a_i = 4i + 7$.

b) Find the sum $\sum_{i=1}^{21} a_i$ for the arithmetic sequence $a_n = 2 - 5n$.

c) Find the sum:
$$\sum_{i=1}^{99} (10 \cdot i + 1)$$

d) Find the sum:
$$\sum_{n=1}^{200} (-9 - n)$$

e) Find the sum of the first 100 terms of the arithmetic sequence:

$$2, 4, 6, 8, 10, 12, \dots$$

f) Find the sum of the first 83 terms of the arithmetic sequence:

$$25, 21, 17, 13, 9, 5, \dots$$

g) Find the sum of the first 75 terms of the arithmetic sequence:

$$2012, 2002, 1992, 1982, \dots$$

h) Find the sum of the first 16 terms of the arithmetic sequence:

$$-11, -6, -1, \dots$$

i) Find the sum of the first 99 terms of the arithmetic sequence:

$$-8, -8.2, -8.4, -8.6, -8.8, -9, -9.2, \dots$$

j) Find the sum

$$7 + 8 + 9 + 10 + \cdots + 776 + 777$$

k) Find the sum of the first 40 terms of the arithmetic sequence:

$$5, 5, 5, 5, 5, \dots$$

Session 24

The geometric series

24.1 Finite geometric series

We now study another sequence, the geometric sequence, which will be analogous to our study of the arithmetic sequence in section 23.2. We have already encountered examples of geometric sequences in Example 23.2(b). A geometric sequence is a sequence for which we *multiply* a constant number to get from one term to the next, for example:

$$5, \xrightarrow{\times 4} 20, \xrightarrow{\times 4} 80, \xrightarrow{\times 4} 320, \xrightarrow{\times 4} 1280, \dots$$

Definition 24.1. A sequence $\{a_n\}$ is called a **geometric sequence**, if any two consecutive terms have a *common ratio* r . The geometric sequence is determined by r and the first value a_1 . This can be written recursively as:

$$a_n = a_{n-1} \cdot r \quad \text{for } n \geq 2$$

Alternatively, we have the general formula for the n th term of the geometric sequence:

$$\boxed{a_n = a_1 \cdot r^{n-1}} \quad (24.1)$$

Example 24.2. Determine if the sequence is a geometric, or arithmetic sequence, or neither or both. If it is a geometric or arithmetic sequence, then find the general formula for a_n in the form (24.1) or (23.2).

- | | |
|---------------------------------------|----------------------------|
| a) 3, 6, 12, 24, 48, ... | b) 100, 50, 25, 12.5, ... |
| c) 700, -70, 7, -0.7, 0.07, ... | d) 2, 4, 16, 256, ... |
| e) 3, 10, 17, 24, ... | f) -3, -3, -3, -3, -3, ... |
| g) $a_n = \left(\frac{3}{7}\right)^n$ | h) $a_n = n^2$ |

Solution. a) Calculating the quotient of two consecutive terms always gives the same number $6 \div 3 = 2$, $12 \div 6 = 2$, $24 \div 12 = 2$, etc. Therefore the common ratio is $r = 2$, which shows that this is a geometric sequence. Furthermore, the first term is $a_1 = 3$, so that the general formula for the n th term is $a_n = 3 \cdot 2^{n-1}$.

b) We see that the common ratio between two terms is $r = \frac{1}{2}$, so that this is a geometric sequence. Since the first term is $a_1 = 100$, we have the general term $a_n = 100 \cdot \left(\frac{1}{2}\right)^{n-1}$.

c) Two consecutive terms have a ratio of $r = -\frac{1}{10}$, and the first term is $a_1 = 700$. The general term of this geometric sequence is $a_n = 700 \cdot \left(-\frac{1}{10}\right)^{n-1}$.

d) The quotient of the first two terms is $4 \div 2 = 2$, whereas the quotient of the next two terms is $16 \div 4 = 4$. Since these quotients are not equal, this is not a geometric sequence. Furthermore, the difference between the first two terms is $4 - 2 = 2$, and the next two terms have a difference $16 - 4 = 12$. Therefore, this is also not an arithmetic sequence.

e) The quotient of the first couple of terms is not equal $\frac{10}{3} \neq \frac{17}{10}$, so that this is not a geometric sequence. The difference of any two terms is $7 = 10 - 3 = 17 - 10 = 24 - 17$, so that this is part of an arithmetic sequence with common difference $d = 7$. The general formula is $a_n = a_1 + d \cdot (n - 1) = 3 + 7 \cdot (n - 1)$.

f) The common ratio is $r = (-3) \div (-3) = 1$, so that this is a geometric sequence with $a_n = (-3) \cdot 1^{n-1}$. On the other hand, the common difference is $(-3) - (-3) = 0$, so that this is *also* an arithmetic sequence with $a_n = (-3) + 0 \cdot (n - 1)$. Of course, both formulas reduce to the simpler expression $a_n = -3$.

g) Writing the first couple of terms in the sequence $\left\{\left(\frac{3}{7}\right)^n\right\}$, we obtain:

$$\left(\frac{3}{7}\right)^1, \left(\frac{3}{7}\right)^2, \left(\frac{3}{7}\right)^3, \left(\frac{3}{7}\right)^4, \left(\frac{3}{7}\right)^5, \dots$$

Thus, we get from one term to the next by multiplying $r = \frac{3}{7}$, so that this is a geometric sequence. The first term is $a_1 = \frac{3}{7}$, so that $a_n = \frac{3}{7} \cdot \left(\frac{3}{7}\right)^{n-1}$. This is clearly the given sequence, since we may simplify this as

$$a_n = \frac{3}{7} \cdot \left(\frac{3}{7}\right)^{n-1} = \left(\frac{3}{7}\right)^{1+n-1} = \left(\frac{3}{7}\right)^n$$

h) We write the first terms in the sequence $\{n^2\}_{n \geq 1}$:

$$1, 4, 9, 16, 25, 36, 49, \dots$$

Calculating the quotients of consecutive terms, we get $4 \div 1 = 4$ and $9 \div 4 = 2.25$, so that this is not a geometric sequence. Also the difference of consecutive terms is $4 - 1 = 3$ and $9 - 4 = 5$, so that this is also not an arithmetic sequence. \square

Example 24.3. Find the general formula of a geometric sequence with the given property.

- a) $r = 4$, and $a_5 = 6400$
- b) $a_1 = \frac{2}{5}$, and $a_4 = -\frac{27}{20}$
- c) $a_5 = 216$, $a_7 = 24$, and r is positive

Solution. a) Since $\{a_n\}$ is a geometric sequence, it is $a_n = a_1 \cdot r^{n-1}$. We know that $r = 4$, so we still need to find a_1 . Using $a_5 = 6400$, we obtain:

$$6400 = a_5 = a_1 \cdot 4^{5-1} = a_1 \cdot 4^4 = 256 \cdot a_1 \xrightarrow{(\div 256)} a_1 = \frac{6400}{256} = 25$$

The sequence is therefore given by the formula, $a_n = 25 \cdot 4^{n-1}$.

b) The geometric sequence $a_n = a_1 \cdot r^{n-1}$ has $a_1 = \frac{2}{5}$. We calculate r using the second condition.

$$\begin{aligned} -\frac{27}{20} = a_4 = a_1 \cdot r^{4-1} = \frac{2}{5} \cdot r^3 &\xrightarrow{(\times \frac{5}{2})} r^3 = -\frac{27}{20} \cdot \frac{5}{2} = -\frac{27}{4} \cdot \frac{1}{2} = \frac{-27}{8} \\ &\xrightarrow{(\text{take } \sqrt[3]{})} r = \sqrt[3]{\frac{-27}{8}} = \frac{\sqrt[3]{-27}}{\sqrt[3]{8}} = \frac{-3}{2} \end{aligned}$$

Therefore, $a_n = \frac{2}{5} \cdot \left(\frac{-3}{2}\right)^{n-1}$.

c) The question does neither provide a_1 nor r in the formula $a_n = a_1 \cdot r^{n-1}$. However, we obtain two equations in the two variables a_1 and r :

$$\begin{cases} 216 = a_5 = a_1 \cdot r^{5-1} \\ 24 = a_7 = a_1 \cdot r^{7-1} \end{cases} \implies \begin{cases} 216 = a_1 \cdot r^4 \\ 24 = a_1 \cdot r^6 \end{cases}$$

In order to solve this, we need to eliminate one of the variables. Looking at the equations on the right, we see dividing the top equation by the bottom equation cancels a_1 .

$$\frac{216}{24} = \frac{a_1 \cdot r^4}{a_1 \cdot r^6} \implies \frac{9}{1} = \frac{1}{r^2} \xrightarrow{(\text{take reciprocal})} \frac{1}{9} = \frac{r^2}{1} \implies r^2 = \frac{1}{9}$$

To obtain r we have to solve this quadratic equation. In general, there are in fact two solutions:

$$r = \pm \sqrt{\frac{1}{9}} = \pm \frac{1}{3}$$

Since the problem states that r is positive, we see that we need to take the positive solution $r = \frac{1}{3}$. Plugging $r = \frac{1}{3}$ back into either of the two equations, we may solve for a_1 . For example, using the first equation $a_5 = 216$, we obtain:

$$\begin{aligned} 216 = a_5 &= a_1 \cdot \left(\frac{1}{3}\right)^{5-1} = a_1 \cdot \left(\frac{1}{3}\right)^4 = a_1 \cdot \frac{1}{3^4} = a_1 \cdot \frac{1}{81} \\ \xRightarrow{(\times 81)} a_1 &= 81 \cdot 216 = 17496 \end{aligned}$$

So, we finally arrive at the general formula for the n th term of the geometric sequence, $a_n = 17496 \cdot \left(\frac{1}{3}\right)^{n-1}$. \square

We can find the sum of the first k terms of a geometric sequence using another trick, which is very different from the one we used for the arithmetic sequence.

Example 24.4. Consider the geometric sequence $a_n = 8 \cdot 5^{n-1}$, that is the sequence:

$$8, 40, 200, 1000, 5000, 25000, 125000, \dots$$

We want to add the first 6 terms of this sequence.

$$8 + 40 + 200 + 1000 + 5000 + 25000 = 31248$$

In general, it may be much more difficult to simply add the terms as we did above, and we need to use a better general method. For this, we multiply $(1 - 5)$ to the sum $(8 + 40 + 200 + 1000 + 5000 + 25000)$ and simplify this using the distributive law:

$$\begin{aligned} &(1 - 5) \cdot (8 + 40 + 200 + 1000 + 5000 + 25000) \\ &= 8 - 40 + 40 - 200 + 200 - 1000 + 1000 - 5000 \\ &\quad + 5000 - 25000 + 25000 - 125000 \\ &= 8 - 125000 \end{aligned}$$

In the second and third lines above, we have what is called a *telescopic sum*, which can be canceled except for the very first and last terms. Dividing by $(1 - 5)$, we obtain:

$$8 + 40 + 200 + 1000 + 5000 + 25000 = \frac{8 - 125000}{1 - 5} = \frac{-124992}{-4} = 31248$$

The previous example generalizes to the more general setting starting with an arbitrary geometric sequence.

Observation 24.5. Let $\{a_n\}$ be a geometric sequence, whose n th term is given by the formula $a_n = a_1 \cdot r^{n-1}$. We furthermore assume that $r \neq 1$. Then, the sum $a_1 + a_2 + \cdots + a_{k-1} + a_k$ is given by:

$$\boxed{\sum_{i=1}^k a_i = a_1 \cdot \frac{1 - r^k}{1 - r}} \quad (24.2)$$

Proof. We multiply $(1 - r)$ to the sum $(a_1 + a_2 + \cdots + a_{k-1} + a_k)$:

$$\begin{aligned} & (1 - r) \cdot (a_1 + a_2 + \cdots + a_k) \\ &= (1 - r) \cdot (a_1 \cdot r^0 + a_1 \cdot r^1 + \cdots + a_1 \cdot r^{k-1}) \\ &= a_1 \cdot r^0 - a_1 \cdot r^1 + a_1 \cdot r^1 - a_1 \cdot r^2 + \cdots + a_1 \cdot r^{k-1} - a_1 \cdot r^k \\ &= a_1 \cdot r^0 - a_1 \cdot r^k = a_1 \cdot (1 - r^k) \end{aligned}$$

Dividing by $(1 - r)$, we obtain

$$a_1 + a_2 + \cdots + a_k = \frac{a_1 \cdot (1 - r^k)}{(1 - r)} = a_1 \cdot \frac{1 - r^k}{1 - r}$$

This is the formula we wanted to prove. \square

Example 24.6. Find the value of the geometric series.

a) Find the sum $\sum_{n=1}^6 a_n$ for the geometric sequence $a_n = 10 \cdot 3^{n-1}$.

b) Determine the value of the geometric series: $\sum_{k=1}^5 \left(-\frac{1}{2}\right)^k$

c) Find the sum of the first 12 terms of the geometric sequence

$$-3, -6, -12, -24, \dots$$

Solution. a) We need to find the sum $a_1 + a_2 + a_3 + a_4 + a_5 + a_6$, and we will do so using the formula provided in equation (24.2). Since $a_n = 10 \cdot 3^{n-1}$, we have $a_1 = 10$ and $r = 3$, so that

$$\sum_{n=1}^6 a_n = 10 \cdot \frac{1-3^6}{1-3} = 10 \cdot \frac{1-729}{1-3} = 10 \cdot \frac{-728}{-2} = 10 \cdot 364 = 3640$$

b) Again, we use the formula for the geometric series $\sum_{k=1}^n a_k = a_1 \cdot \frac{1-r^n}{1-r}$, since $a_k = (-\frac{1}{2})^k$ is a geometric series. We may calculate the first term $a_1 = -\frac{1}{2}$, and the common ratio is also $r = -\frac{1}{2}$. With this, we obtain:

$$\begin{aligned} \sum_{k=1}^5 \left(-\frac{1}{2}\right)^k &= \left(-\frac{1}{2}\right) \cdot \frac{1 - \left(-\frac{1}{2}\right)^5}{1 - \left(-\frac{1}{2}\right)} = \left(-\frac{1}{2}\right) \cdot \frac{1 - \left((-1)^5 \frac{1^5}{2^5}\right)}{1 - \left(-\frac{1}{2}\right)} = \\ &= \left(-\frac{1}{2}\right) \cdot \frac{1 - \left(-\frac{1}{32}\right)}{1 - \left(-\frac{1}{2}\right)} = \left(-\frac{1}{2}\right) \cdot \frac{1 + \frac{1}{32}}{1 + \frac{1}{2}} = \left(-\frac{1}{2}\right) \cdot \frac{\frac{32+1}{32}}{\frac{2+1}{2}} \\ &= \left(-\frac{1}{2}\right) \cdot \frac{\frac{33}{32}}{\frac{3}{2}} = \left(-\frac{1}{2}\right) \cdot \frac{33}{32} \cdot \frac{2}{3} = -\frac{1}{2} \cdot \frac{11}{16} = -\frac{11}{32} \end{aligned}$$

c) Our first task is to find the formula for the provided geometric series $-3, -6, -12, -24, \dots$. The first term is $a_1 = -3$ and the common ratio is $r = 2$, so that $a_n = (-3) \cdot 2^{n-1}$. The sum of the first 12 terms of this sequence is again given by equation (24.2):

$$\begin{aligned} \sum_{i=1}^{12} (-3) \cdot 2^{i-1} &= (-3) \cdot \frac{1-2^{12}}{1-2} = (-3) \cdot \frac{1-4096}{1-2} = (-3) \cdot \frac{-4095}{-1} \\ &= (-3) \cdot 4095 = -12285 \end{aligned}$$

□

24.2 Infinite geometric series

In some cases, it makes sense to add not only finitely many terms of a geometric sequence, but all infinitely many terms of the sequence! An informal and very intuitive infinite geometric series is exhibited in the next example.

Example 24.7. Consider the geometric sequence

$$1, \frac{1}{2}, \frac{1}{4}, \frac{1}{8}, \frac{1}{16}, \dots$$

Here, the common ratio is $r = \frac{1}{2}$, and the first term is $a_1 = 1$, so that the formula for a_n is $a_n = \left(\frac{1}{2}\right)^{n-1}$. We are interested in summing *all infinitely many* terms of this sequence:

$$1 + \frac{1}{2} + \frac{1}{4} + \frac{1}{8} + \frac{1}{16} + \dots$$

We add these terms one by one, and picture these sums on the number line:

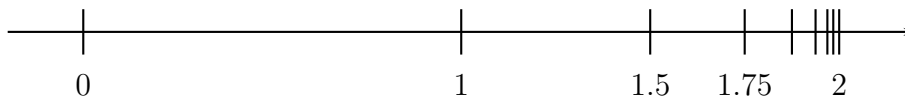

$$\begin{aligned} 1 &= 1 \\ 1 + \frac{1}{2} &= 1.5 \\ 1 + \frac{1}{2} + \frac{1}{4} &= 1.75 \\ 1 + \frac{1}{2} + \frac{1}{4} + \frac{1}{8} &= 1.875 \\ 1 + \frac{1}{2} + \frac{1}{4} + \frac{1}{8} + \frac{1}{16} &= 1.9375 \end{aligned}$$

We see that adding each term takes the sum closer and closer to the number 2. More precisely, adding a term a_n to the partial sum $a_1 + \dots + a_{n-1}$ cuts the distance between 2 and $a_1 + \dots + a_{n-1}$ in half. For this reason we can, in fact, get arbitrarily close to 2, so that it is reasonable to expect that

$$1 + \frac{1}{2} + \frac{1}{4} + \frac{1}{8} + \frac{1}{16} + \dots = 2$$

In the next definition and observation, this equation will be justified and made more precise.

We start by providing the definition of an infinite series.

Definition 24.8. An infinite series is given by the

$$\sum_{i=1}^{\infty} a_i = a_1 + a_2 + a_3 + \dots \quad (24.3)$$

To be more precise, the infinite sum is defined as the limit $\sum_{i=1}^{\infty} a_i := \lim_{k \rightarrow \infty} \left(\sum_{i=1}^k a_i \right)$. Therefore, an infinite sum is defined, precisely when this limit exists.

Observation 24.9. Let $\{a_n\}$ be a geometric sequence with $a_n = a_1 \cdot r^{n-1}$. Then the infinite geometric series is defined whenever $-1 < r < 1$. In this case, we have:

$$\boxed{\sum_{i=1}^{\infty} a_i = a_1 \cdot \frac{1}{1-r}} \quad (24.4)$$

Proof. Informally, this follows from the formula $\sum_{i=1}^k a_i = a_1 \cdot \frac{1-r^k}{1-r}$ and the fact that r^k approaches zero when k increases without bound.

More formally, the proof uses the notion of limits, and goes as follows:

$$\sum_{i=1}^{\infty} a_i = \lim_{k \rightarrow \infty} \left(\sum_{i=1}^k a_i \right) = \lim_{k \rightarrow \infty} \left(a_1 \cdot \frac{1-r^k}{1-r} \right) = a_1 \cdot \frac{1 - \lim_{k \rightarrow \infty} (r^k)}{1-r} = a_1 \cdot \frac{1}{1-r}$$

□

Example 24.10. Find the value of the infinite geometric series.

- $\sum_{j=1}^{\infty} a_j$, for $a_j = 5 \cdot \left(\frac{1}{3}\right)^{j-1}$
- $\sum_{n=1}^{\infty} 3 \cdot (0.71)^n$
- $500 - 100 + 20 - 4 + \dots$
- $3 + 6 + 12 + 24 + 48 + \dots$

Solution. a) We use formula (24.4) for the geometric series $a_n = 5 \cdot \left(\frac{1}{3}\right)^{n-1}$, that is $a_1 = 5 \cdot \left(\frac{1}{3}\right)^{1-1} = 5 \cdot \left(\frac{1}{3}\right)^0 = 5 \cdot 1 = 5$ and $r = \frac{1}{3}$. Therefore,

$$\sum_{j=1}^{\infty} a_j = a_1 \cdot \frac{1}{1-r} = 5 \cdot \frac{1}{1-\frac{1}{3}} = 5 \cdot \frac{1}{\frac{3-1}{3}} = 5 \cdot \frac{1}{\frac{2}{3}} = 5 \cdot \frac{3}{2} = \frac{15}{2}$$

b) In this case, $a_n = 3 \cdot (0.71)^n$, so that $a_1 = 3 \cdot 0.71^1 = 3 \cdot 0.71 = 2.13$ and $r = 0.71$. Using again formula (24.4), we can find the infinite geometric series as

$$\sum_{n=1}^{\infty} 3 \cdot (0.71)^n = a_1 \cdot \frac{1}{1-r} = 2.13 \cdot \frac{1}{1-0.71} = 2.13 \cdot \frac{1}{0.29} = \frac{2.13}{0.29} = \frac{213}{29}$$

In the last step we simplified the fraction by multiplying both numerator and denominator by 100, which had the effect of eliminating the decimals.

c) Our first task is to identify the given sequence as an infinite geometric sequence:

$$\{a_n\} \text{ is given by } 500, -100, 20, -4, \dots$$

Notice that the first term is 500, and each consecutive term is given by dividing by -5 , or in other words, by multiplying by the common ratio $r = -\frac{1}{5}$. Therefore, this is an infinite geometric series, which can be evaluated as

$$\begin{aligned} 500 - 100 + 20 - 4 + \dots &= \sum_{n=1}^{\infty} a_n = a_1 \cdot \frac{1}{1-r} = 500 \cdot \frac{1}{1 - (-\frac{1}{5})} \\ &= 500 \cdot \frac{1}{1 + \frac{1}{5}} = \frac{500}{\frac{1+5}{5}} = \frac{500}{\frac{6}{5}} = 500 \cdot \frac{5}{6} \\ &= \frac{2500}{6} = \frac{1250}{3} \end{aligned}$$

d) We want to evaluate the infinite series $3 + 6 + 12 + 24 + 48 + \dots$. The sequence $3, 6, 12, 24, 48, \dots$ is a geometric sequence, with $a_1 = 3$ and common ratio $r = 2$. Since $r \geq 1$, we see that formula (24.4) *cannot* be applied, as (24.4) only applies to $-1 < r < 1$. However, since we add larger and larger terms, the series gets larger than any possible bound, so that the whole sum becomes infinite.

$$3 + 6 + 12 + 24 + 48 + \dots = \infty$$

□

Example 24.11. The fraction $0.55555\dots$ may be written as:

$$0.55555\dots = 0.5 + 0.05 + 0.005 + 0.0005 + 0.00005 + \dots$$

Noting that the sequence

$$0.5, \overset{\curvearrowright}{\underset{\times 0.1}{\rightarrow}} 0.05, \overset{\curvearrowright}{\underset{\times 0.1}{\rightarrow}} 0.005, \overset{\curvearrowright}{\underset{\times 0.1}{\rightarrow}} 0.0005, \overset{\curvearrowright}{\underset{\times 0.1}{\rightarrow}} 0.00005, \dots$$

is a geometric sequence with $a_1 = 0.5$ and $r = 0.1$, we can calculate the infinite sum as:

$$0.55555 \dots = \sum_{i=1}^{\infty} 0.5 \cdot (0.1)^{i-1} = 0.5 \cdot \frac{1}{1-0.1} = 0.5 \cdot \frac{1}{0.9} = \frac{0.5}{0.9} = \frac{5}{9},$$

Here we multiplied numerator and denominator by 10 in the last step in order to eliminate the decimals.

24.3 Exercises

Exercise 24.1. Which of these sequences is geometric, arithmetic, or neither or both. Write the sequence in the usual form $a_n = a_1 + d(n-1)$ if it is an arithmetic sequence and $a_n = a_1 \cdot r^{n-1}$ if it is a geometric sequence.

- | | |
|---|--|
| a) 7, 14, 28, 56, ... | b) 3, -30, 300, -3000, 30000, ... |
| c) 81, 27, 9, 3, 1, $\frac{1}{3}$, ... | d) -7, -5, -3, -1, 1, 3, 5, 7, ... |
| e) $-6, 2, -\frac{2}{3}, \frac{2}{9}, -\frac{2}{27}, \dots$ | f) $-2, -2 \cdot \frac{2}{3}, -2 \cdot (\frac{2}{3})^2, -2 \cdot (\frac{2}{3})^3, \dots$ |
| g) $\frac{1}{2}, \frac{1}{4}, \frac{1}{8}, \frac{1}{16}, \dots$ | h) 2, 2, 2, 2, 2, ... |
| i) 5, 1, 5, 1, 5, 1, 5, 1, ... | j) -2, 2, -2, 2, -2, 2, ... |
| k) 0, 5, 10, 15, 20, ... | l) $5, \frac{5}{3}, \frac{5}{3^2}, \frac{5}{3^3}, \frac{5}{3^4}, \dots$ |
| m) $\frac{1}{2}, \frac{1}{4}, \frac{1}{8}, \frac{1}{16}, \dots$ | n) $\log(2), \log(4), \log(8), \log(16), \dots$ |
| o) $a_n = -4^n$ | p) $a_n = -4n$ |
| q) $a_n = 2 \cdot (-9)^n$ | r) $a_n = (\frac{1}{3})^n$ |
| s) $a_n = -(\frac{5}{7})^n$ | t) $a_n = (-\frac{5}{7})^n$ |
| u) $a_n = \frac{2}{n}$ | v) $a_n = 3n + 1$ |

Exercise 24.2. A geometric sequence, $a_n = a_1 \cdot r^{n-1}$, has the given properties. Find the term a_n of the sequence.

- | | |
|---|---------------------------|
| a) $a_1 = 3$, and $r = 5$, | find a_4 |
| b) $a_1 = 200$, and $r = -\frac{1}{2}$, | find a_6 |
| c) $a_1 = -7$, and $r = 2$, | find a_n (for all n) |
| d) $r = 2$, and $a_4 = 48$, | find a_1 |
| e) $r = 100$, and $a_4 = 900,000$, | find a_n (for all n) |

- f) $a_1 = 20$, $a_4 = 2500$, find a_n (for all n)
 g) $a_1 = \frac{1}{8}$, and $a_6 = \frac{3^5}{8^6}$, find a_n (for all n)
 h) $a_3 = 36$, and $a_6 = 972$, find a_n (for all n)
 i) $a_8 = 4000$, $a_{10} = 40$, and r is negative, find a_n (for all n)

Exercise 24.3. Find the value of the finite geometric series using formula (24.2). Confirm the formula either by adding the the summands directly, or alternatively by using the calculator.

a) Find the sum $\sum_{j=1}^4 a_j$ for the geometric sequence $a_j = 5 \cdot 4^{j-1}$.

b) Find the sum $\sum_{i=1}^7 a_i$ for the geometric sequence $a_n = \left(\frac{1}{2}\right)^n$.

c) Find: $\sum_{m=1}^5 \left(-\frac{1}{5}\right)^m$

d) Find: $\sum_{k=1}^6 2.7 \cdot 10^k$

e) Find the sum of the first 5 terms of the geometric sequence:

$$2, 6, 18, 54, \dots$$

f) Find the sum of the first 6 terms of the geometric sequence:

$$-5, 15, -45, 135, \dots$$

g) Find the sum of the first 8 terms of the geometric sequence:

$$-1, -7, -49, -343, \dots$$

h) Find the sum of the first 10 terms of the geometric sequence:

$$600, -300, 150, -75, 37.5, \dots$$

i) Find the sum of the first 40 terms of the geometric sequence:

$$5, 5, 5, 5, 5, \dots$$

Exercise 24.4. Find the value of the infinite geometric series.

- a) $\sum_{j=1}^{\infty} a_j$, for $a_j = 3 \cdot \left(\frac{2}{3}\right)^{j-1}$ b) $\sum_{j=1}^{\infty} 7 \cdot \left(-\frac{1}{5}\right)^j$
c) $\sum_{j=1}^{\infty} 6 \cdot \frac{1}{3^j}$ d) $\sum_{n=1}^{\infty} -2 \cdot (0.8)^n$
e) $\sum_{n=1}^{\infty} (0.99)^n$ f) $27 + 9 + 3 + 1 + \frac{1}{3} + \dots$
g) $-2 + 1 - \frac{1}{2} + \frac{1}{4} - \dots$ h) $-6 - 2 - \frac{2}{3} - \frac{2}{9} - \dots$
i) $100 + 40 + 16 + 6.4 + \dots$ j) $-54 + 18 - 6 + 2 - \dots$

Exercise 24.5. Rewrite the decimal using an infinite geometric sequence, and then use the formula for infinite geometric series to rewrite the decimal as a fraction (see example 24.11).

- a) 0.44444... b) 0.77777... c) 5.55555... d) 0.2323232323...
e) 39.393939... f) 0.248248248... g) 20.02002... h) 0.5040504...

Session 25

The binomial theorem

25.1 The binomial theorem

Recall the well-known binomial formula:

$$(a + b)^2 = a^2 + 2ab + b^2$$

(since, using "FOIL," we have: $(a + b)^2 = (a + b) \cdot (a + b) = a^2 + ab + ab + b^2 = a^2 + 2ab + b^2$)

In this section we generalize this to find similar expressions for $(a + b)^n$ for any natural number n . This is the content of the (generalized) binomial theorem below. Before we can state the theorem, we need to define the notion of a factorial and combinations.

Definition 25.1. For a natural number $n = 1, 2, 3, \dots$, we define $n!$ to be the number

$$n! = 1 \cdot 2 \cdot 3 \cdot \dots \cdot n$$

The number $n!$ is called n **factorial**.

To make the formulas below work nicely, we also define $0!$ to be $0! = 1$.

It is easy to calculate some examples of factorials.

Example 25.2.

$$\begin{aligned} 4! &= 1 \cdot 2 \cdot 3 \cdot 4 = 24 \\ 7! &= 1 \cdot 2 \cdot 3 \cdot 4 \cdot 5 \cdot 6 \cdot 7 = 5040 \end{aligned}$$

$$2! = 1 \cdot 2 = 2$$

To calculate factorials with the calculator, we have to use the MATH menu (press $\boxed{\text{math}}$), then move to the PRB menu (press $\boxed{\leftarrow}$), and use the fourth item (press $\boxed{4}$).

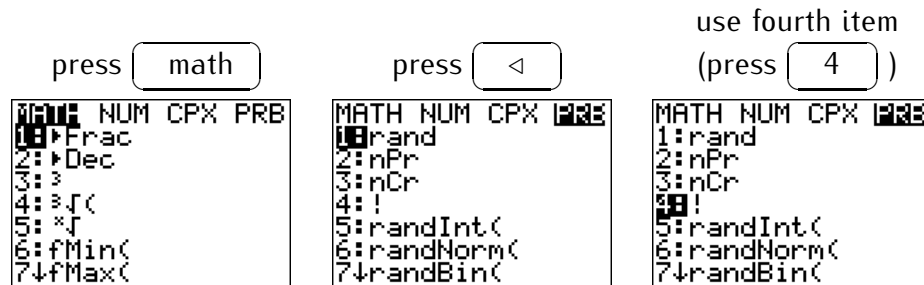

For example, we can calculate $12! = 479001600$ by entering 12 and the factorial symbol as described above.

```

12!          479001600
17!          3.556874281E14
  
```

Note that the factorial becomes very large even for relatively small integers. For example $17! \approx 3.557 \cdot 10^{14}$ as shown above.

The next concept that we introduce is that of the binomial coefficient.

Definition 25.3. Let $n = 0, 1, 2, \dots$ and $r = 0, 1, 2, \dots, n$ be natural numbers or zero, so that $0 \leq r \leq n$. Then we define the **binomial coefficient** as

$$\binom{n}{r} = \frac{n!}{r! \cdot (n-r)!}$$

The binomial coefficient is also written as ${}_nC_r = \binom{n}{r}$, and we read them as “*n-choose-r*.”

Note 25.4. • The binomial coefficient $\binom{n}{r}$ should not be confused with the fraction $\left(\frac{n}{r}\right)$.

- A subset of the set $\{1, 2, \dots, n\}$ with r elements is called an r -**combination**. The binomial coefficient can be interpreted as counting the number of distinct r -combinations. More precisely, there are exactly $\binom{n}{r}$ distinct r -combinations of the set $\{1, \dots, n\}$.

Example 25.5. Calculate the binomial coefficients.

a) $\binom{6}{4}$ b) $\binom{8}{5}$ c) $\binom{25}{23}$ d) $\binom{7}{1}$ e) $\binom{11}{11}$ f) $\binom{11}{0}$

Solution. a) Many binomial coefficients may be calculated by hand, such as:

$$\binom{6}{4} = \frac{6!}{4!(6-4)!} = \frac{6!}{4!2!} = \frac{1 \cdot 2 \cdot 3 \cdot 4 \cdot 5 \cdot 6}{1 \cdot 2 \cdot 3 \cdot 4 \cdot 1 \cdot 2} = \frac{5 \cdot 6}{2} = 15$$

b) Again, we can calculate this by hand

$$\binom{8}{5} = \frac{8!}{5!3!} = \frac{1 \cdot 2 \cdot 3 \cdot 4 \cdot 5 \cdot 6 \cdot 7 \cdot 8}{1 \cdot 2 \cdot 3 \cdot 4 \cdot 5 \cdot 1 \cdot 2 \cdot 3} = \frac{6 \cdot 7 \cdot 8}{1 \cdot 2 \cdot 3} = 7 \cdot 8 = 56$$

However, we can also use the calculator to find the answer. Using the MATH and (press $\boxed{\text{math}}$) PRB menus (press $\boxed{\leftarrow}$) as above, we use the third item (press $\boxed{3}$). The answer is obtained by pressing the following sequence of keys:

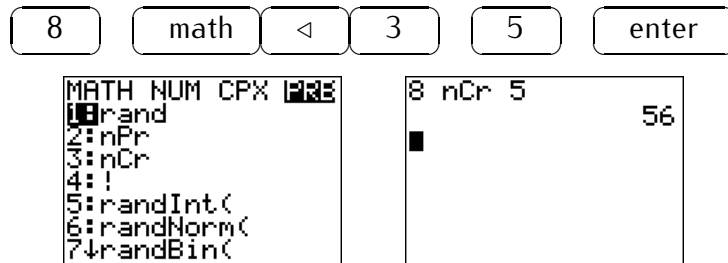

We also calculate the remaining binomial coefficients (c)-(f), which can also be confirmed with the calculator.

$$\text{c) } \binom{25}{23} = \frac{25!}{23! \cdot 2!} = \frac{23! \cdot 24 \cdot 25}{23! \cdot 1 \cdot 2} = \frac{24 \cdot 25}{2} = 300$$

$$\text{d) } \binom{7}{1} = \frac{7!}{1! \cdot 6!} = \frac{6! \cdot 7}{1 \cdot 6!} = \frac{7}{1} = 7$$

$$\text{e) } \binom{11}{11} = \frac{11!}{11! \cdot 0!} = \frac{1}{1 \cdot 1} = 1$$

$$\text{f) } \binom{11}{0} = \frac{11!}{0! \cdot 11!} = \frac{1}{1 \cdot 1} = 1$$

Note that in the last two equations we needed to use the fact that $0! = 1$. \square

The binomial coefficients appear in the expressions for $(a + b)^n$ as we will see in the next example.

Example 25.8. We now calculate some simple examples.

$$\begin{aligned}(a + b)^3 &= (a + b) \cdot (a + b) \cdot (a + b) \\ &= (a^2 + 2ab + b^2) \cdot (a + b) \\ &= a^3 + 2a^2b + ab^2 + a^2b + 2ab^2 + b^3 \\ &= a^3 + 3a^2b + 3ab^2 + b^3\end{aligned}$$

Note that the coefficients 1, 3, 3, and 1 in front of a^3 , a^2b , ab^2 , and b^3 , respectively, are precisely the binomial coefficients $\binom{3}{0}$, $\binom{3}{1}$, $\binom{3}{2}$, and $\binom{3}{3}$.

We also calculate the fourth power.

$$\begin{aligned}(a + b)^4 &= (a + b) \cdot (a + b) \cdot (a + b) \cdot (a + b) \\ &= (a^3 + 3a^2b + 3ab^2 + b^3) \cdot (a + b) \\ &= a^4 + 3a^3b + 3a^2b^2 + ab^3 + a^3b + 3a^2b^2 + 3ab^3 + b^4 \\ &= a^4 + 4a^3b + 6a^2b^2 + 4ab^3 + b^4\end{aligned}$$

Again, the numbers 1, 4, 6, 4, and 1 are precisely the binomial coefficients $\binom{4}{0}$, $\binom{4}{1}$, $\binom{4}{2}$, $\binom{4}{3}$, and $\binom{4}{4}$.

We are now ready to state the general **binomial theorem**:

Theorem 25.9 (Binomial theorem). The n th power $(a + b)^n$ can be expanded as:

$$(a + b)^n = \binom{n}{0}a^n + \binom{n}{1}a^{n-1}b + \binom{n}{2}a^{n-2}b^2 + \cdots + \binom{n}{n-1}a^1b^{n-1} + \binom{n}{n}b^n$$

Using the summation symbol, we may write this in short:

$$\boxed{(a + b)^n = \sum_{r=0}^n \binom{n}{r} \cdot a^{n-r} \cdot b^r} \quad (25.1)$$

Example 25.10. Expand $(a + b)^5$.

Solution.

$$\begin{aligned}(a + b)^5 &= \binom{5}{0}a^5 + \binom{5}{1}a^4b + \binom{5}{2}a^3b^2 + \binom{5}{3}a^2b^3 + \binom{5}{4}a^1b^4 + \binom{5}{5}b^5 \\ &= a^5 + 5a^4b + 10a^3b^2 + 10a^2b^3 + 5ab^4 + b^5\end{aligned}$$

□

25.2 Binomial expansion

Using the binomial theorem, we can also expand more general powers of sums or differences.

Example 25.11. Expand the expression.

$$\text{a) } (x^2 + 2y^3)^5 \quad \text{b) } (2xy^2 - \frac{4}{y^2})^3 \quad \text{c) } (\sqrt{2} + 1)^6 \quad \text{d) } (i - 3)^4$$

Solution. a) We use the binomial theorem with $a = x^2$ and $b = 2y^3$:

$$\begin{aligned} (x^2 + 2y^3)^5 &= (x^2)^5 + \binom{5}{1}(x^2)^4(2y^3) + \binom{5}{2}(x^2)^3(2y^3)^2 \\ &\quad + \binom{5}{3}(x^2)^2(2y^3)^3 + \binom{5}{4}(x^2)(2y^3)^4 + (2y^3)^5 \\ &= x^{10} + 5x^8 \cdot 2y^3 + 10x^6 \cdot 4y^6 + 10x^4 \cdot 2^3y^9 + 5x^2 \cdot 2^4y^{12} + 2^5y^{15} \\ &= x^{10} + 10x^8y^3 + 40x^6y^6 + 80x^4y^9 + 80x^2y^{12} + 32y^{15} \end{aligned}$$

b) For part (b), it is $a = 2xy^2$ and $b = -\frac{4}{y^2}$.

$$\begin{aligned} (2xy^2 - \frac{4}{y^2})^3 &= (2xy^2)^3 + \binom{3}{1}(2xy^2)^2(-\frac{4}{y^2}) + \binom{3}{2}(2xy^2)(-\frac{4}{y^2})^2 + (-\frac{4}{y^2})^3 \\ &= 2^3x^3y^6 + 3 \cdot 2^2x^2y^4(-\frac{4}{y^2}) + 3(2xy^2)(-1)^2\frac{4^2}{y^4} + (-1)^3\frac{4^3}{y^6} \\ &= 8x^3y^6 - 48x^2y^2 + 96x \cdot \frac{1}{y^2} - 64 \cdot \frac{1}{y^6} \end{aligned}$$

c) Similarly, for part (c), we now have $a = \sqrt{2}$ and $b = 1$:

$$\begin{aligned} (\sqrt{2} + 1)^6 &= (\sqrt{2})^6 + \binom{6}{1}(\sqrt{2})^5 \cdot 1 + \binom{6}{2}(\sqrt{2})^4 \cdot 1^2 + \binom{6}{3}(\sqrt{2})^3 \cdot 1^3 \\ &\quad + \binom{6}{4}(\sqrt{2})^2 \cdot 1^4 + \binom{6}{5}(\sqrt{2}) \cdot 1^5 + 1^6 \\ &= \sqrt{64} + 6 \cdot \sqrt{32} + 15 \cdot \sqrt{16} + 20 \cdot \sqrt{8} + 15 \cdot \sqrt{4} + 6 \cdot \sqrt{2} + 1 \\ &= 8 + 6 \cdot \sqrt{16 \cdot 2} + 15 \cdot 4 + 20 \cdot \sqrt{4 \cdot 2} + 15 \cdot 2 + 6 \cdot \sqrt{2} + 1 \end{aligned}$$

$$\begin{aligned}
 &= 8 + 24\sqrt{2} + 60 + 40\sqrt{2} + 30 + 6\sqrt{2} + 1 \\
 &= 99 + 70\sqrt{2}
 \end{aligned}$$

Note that the last expression cannot be simplified any further (due to the order of operations).

d) Finally, we have $a = i$ and $b = -3$, and we use the fact that $i^2 = -1$, and therefore, $i^3 = -i$ and $i^4 = +1$:

$$\begin{aligned}
 (i - 3)^4 &= i^4 + \binom{4}{1} \cdot i^3 \cdot (-3) + \binom{4}{2} \cdot i^2 \cdot (-3)^2 + \binom{4}{3} \cdot i \cdot (-3)^3 + (-3)^4 \\
 &= 1 + 4 \cdot (-i) \cdot (-3) + 6 \cdot (-1) \cdot 9 + 4 \cdot i \cdot (-27) + 81 \\
 &= 1 + 12i - 54 - 108i + 81 \\
 &= 28 - 96i
 \end{aligned}$$

□

In some instances it is not necessary to write the full binomial expansion, but it is enough to find a particular term, say the k th term of the expansion.

Observation 25.12. Recall, for example, the binomial expansion of $(a + b)^6$:

$$\binom{6}{0}a^6b^0 + \binom{6}{1}a^5b^1 + \binom{6}{2}a^4b^2 + \binom{6}{3}a^3b^3 + \binom{6}{4}a^2b^4 + \binom{6}{5}a^1b^5 + \binom{6}{6}a^0b^6$$

first	second	third	fourth	fifth	sixth	seventh
term	term	term	term	term	term	term

Note that the exponents of the a 's and b 's for each term always add up to 6, and that the exponents of a decrease from 6 to 0, and the exponents of b increase from 0 to 6. Furthermore observe that in the above expansion the fifth term is $\binom{6}{4}a^2b^4$.

In general, we define the k th term by the following formula:

$$\text{The } k\text{th term in the expansion of } (a + b)^n \text{ is: } \boxed{\binom{n}{k-1} a^{n-k+1} b^{k-1}} \quad (25.2)$$

Note in particular, that the k th term has a power of b given by b^{k-1} (and *not* b^k), it has a binomial coefficient $\binom{n}{k-1}$, and the exponents of a and b add up to n .

Example 25.13. Determine:

- the 4th term in the binomial expansion of $(p + 3q)^5$
- the 8th term in the binomial expansion of $(x^3y - 2x^2)^{10}$
- the 12th term in the binomial expansion of $(-\frac{5a}{b^7} - b)^{15}$

Solution. a) We have $a = p$ and $b = 3q$, and $n = 5$ and $k = 4$. Thus, the binomial coefficient of the 4th term is $\binom{5}{3}$, the b -term is $(3q)^3$, and the a -term is p^2 . The 4th term is therefore given by

$$\binom{5}{3} \cdot p^2 \cdot (3q)^3 = 10 \cdot p^2 \cdot 3^3 q^3 = 270p^2q^3$$

b) In this case, $a = x^3y$ and $b = -2x^2$, and furthermore, $n = 10$ and $k = 8$. The binomial coefficient of the 8th term is $\binom{10}{7}$, the b -term is $(-2x^2)^7$, and the a -term is $(x^3y)^3$. Therefore, the 8th term is

$$\binom{10}{7} \cdot (x^3y)^3 \cdot (-2x^2)^7 = 120 \cdot x^9y^3 \cdot (-128)x^{14} = -15360 \cdot x^{23}y^3$$

c) Similarly, we obtain the 12th term of $(-\frac{5a}{b^7} - b)^{15}$ as

$$\begin{aligned} \binom{15}{11} \cdot \left(-\frac{5a}{b^7}\right)^4 \cdot (-b)^{11} &= 1365 \cdot \frac{5^4 a^4}{b^{28}} \cdot (-b^{11}) = 1365 \cdot \frac{625 \cdot a^4 \cdot (-b^{11})}{b^{28}} \\ &= -853125 \cdot \frac{a^4}{b^{17}} \end{aligned}$$

□

Here is a variation of the above problem.

Example 25.14. Determine:

- the x^4y^{12} -term in the binomial expansion of $(5x^2 + 2y^3)^6$
- the x^{15} -term in the binomial expansion of $(x^3 - x)^7$
- the real part of the complex number $(3 + 2i)^4$

Solution. a) In this case we have $a = 5x^2$ and $b = 2y^3$. The term x^4y^{12} can be rewritten as $x^4y^{12} = (x^2)^2 \cdot (y^3)^4$, so that the full term $\binom{n}{k-1} a^{n-k+1} b^{k-1}$ (including the coefficients) is

$$\binom{6}{4} \cdot (5x^2)^2 \cdot (2y^3)^4 = 15 \cdot 25x^4 \cdot 16y^{12} = 6000 \cdot x^4y^{12}$$

b) The various powers of x in $(x^3 - x)^7$ (in the order in which they appear in the binomial expansion) are:

$$(x^3)^7 = x^{21}, \quad (x^3)^6 \cdot x^1 = x^{19}, \quad (x^3)^5 \cdot x^2 = x^{17}, \quad (x^3)^4 \cdot x^3 = x^{15}, \quad \dots$$

The last term is precisely the x^{15} -term, that is we take the fourth term, $k = 4$. We obtain a total term (including the coefficients) of

$$\binom{7}{3} \cdot (x^3)^4 \cdot (-x)^3 = 35 \cdot x^{12} \cdot (-x)^3 = -35 \cdot x^{15}$$

c) Recall that i^n is real when n is even, and imaginary when n is odd:

$$\begin{aligned} i^1 &= i \\ i^2 &= -1 \\ i^3 &= -i \\ i^4 &= 1 \\ i^5 &= i \\ i^6 &= -1 \\ &\vdots \end{aligned}$$

The real part of $(3 + 2i)^4$ is therefore given by the first, third, and fifth term of the binomial expansion:

$$\begin{aligned} \text{real part} &= \binom{4}{0} \cdot 3^4 \cdot (2i)^0 + \binom{4}{2} \cdot 3^2 \cdot (2i)^2 + \binom{4}{4} \cdot 3^0 \cdot (2i)^4 \\ &= 1 \cdot 81 \cdot 1 + 6 \cdot 9 \cdot 4i^2 + 1 \cdot 1 \cdot 16i^4 = 81 + 216 \cdot (-1) + 16 \cdot 1 \\ &= 81 - 216 + 16 = -119 \end{aligned}$$

The real part of $(3 + 2i)^4$ is -119 . □

25.3 Exercises

Exercise 25.1. Find the value of the factorial or binomial coefficient.

$$\begin{array}{llllllll} \text{a) } 5! & \text{b) } 3! & \text{c) } 9! & \text{d) } 2! & \text{e) } 0! & \text{f) } 1! & \text{g) } 19! & \text{h) } 64! \\ \text{i) } \binom{5}{2} & \text{j) } \binom{9}{6} & \text{k) } \binom{12}{1} & \text{l) } \binom{12}{0} & \text{m) } \binom{23}{22} & \text{n) } \binom{19}{12} & \text{o) } \binom{13}{11} & \text{p) } \binom{16}{5} \end{array}$$

Exercise 25.2. Expand the expression via the binomial theorem.

$$\text{a) } (m + n)^4 \quad \text{b) } (x + 2)^5 \quad \text{c) } (x - y)^6 \quad \text{d) } (-p - q)^5$$

Exercise 25.3. Expand the expression.

a) $(x - 2y)^3$ b) $(x - 10)^4$ c) $(x^2y + y^2)^5$ d) $(2y^2 - 5x^4)^4$
e) $(x + \sqrt{x})^3$ f) $(-2\frac{x^2}{y} - \frac{y^3}{x})^5$ g) $(\sqrt{2} - 2\sqrt{3})^3$ h) $(1 - i)^3$

Exercise 25.4. Determine:

- the first 3 terms in the binomial expansion of $(xy - 4x)^5$
- the first 2 terms in the binomial expansion of $(2a^2 + b^3)^9$
- the last 3 terms in the binomial expansion of $(3y^2 - x^2)^7$
- the first 3 terms in the binomial expansion of $(\frac{x}{y} - \frac{y}{x})^{10}$
- the last 4 terms in the binomial expansion of $(m^3n + \frac{1}{2}n^2)^6$

Exercise 25.5. Determine:

- the 5th term in the binomial expansion of $(x + y)^7$
- the 3rd term in the binomial expansion of $(x^2 - y)^9$
- the 10th term in the binomial expansion of $(2 - w)^{11}$
- the 5th term in the binomial expansion of $(2x + xy)^7$
- the 7th term in the binomial expansion of $(2a + 5b)^6$
- the 6th term in the binomial expansion of $(3p^2 - q^3p)^7$
- the 10th term in the binomial expansion of $(4 + \frac{b}{2})^{13}$

Exercise 25.6. Determine:

- the x^3y^6 -term in the binomial expansion of $(x + y)^9$
- the r^4s^4 -term in the binomial expansion of $(r^2 - s)^6$
- the x^4 -term in the binomial expansion of $(x - 1)^{11}$
- the x^3y^6 -term in the binomial expansion of $(x^3 + 5y^2)^4$
- the x^7 -term in the binomial expansion of $(2x - x^2)^5$
- the imaginary part of the number $(1 + i)^3$

Review of complex numbers, sequences, and the binomial theorem

Exercise V.1. Multiply and write the answer in standard form:

$$(-4)(\cos(207^\circ) + i \sin(207^\circ)) \cdot 2(\cos(33^\circ) + i \sin(33^\circ))$$

Exercise V.2. Divide and write the answer in standard form:

$$\frac{3(\cos(\frac{\pi}{3}) + i \sin(\frac{\pi}{3}))}{15(\cos(\frac{\pi}{2}) + i \sin(\frac{\pi}{2}))}$$

Exercise V.3. Find the magnitude and directional angle of the vector

$$\vec{v} = \langle -7, -7\sqrt{3} \rangle.$$

Exercise V.4. Determine if the sequence is an arithmetic or geometric sequence or neither. If it is one of these, then find the general formula for the n th term a_n of the sequence.

- a) $54, -18, 6, -2, \frac{2}{3}, \dots$
- b) $2, 4, 8, 10, \dots$
- c) $9, 5, 1, -3, -7, \dots$

Exercise V.5. Find the sum of the first 75 terms of the arithmetic sequence:

$$-30, -22, -14, -6, 2, \dots$$

Exercise V.6. Find the sum of the first 8 terms of the geometric series:

$$-7, -14, -28, -56, -112, \dots$$

Exercise V.7. Find the value of the infinite geometric series:

$$80 - 20 + 5 - 1.25 + \dots$$

Exercise V.8. Expand the expression via the binomial theorem.

$$(3x^2 - 2xy)^3$$

Exercise V.9. Write the first 3 terms of the binomial expansion:

$$\left(ab^2 + \frac{10}{a}\right)^9$$

Exercise V.10. Find the 6th term of the binomial expansion:

$$(5p - q^2)^8$$

Appendix A

Introduction to the TI-84

A.1 Basic calculator functions

In this section we explain the basic functions of the calculator. There are various buttons and screens. We will describe below those which are most useful for us.

The main screen The main screen is the screen that appears when you first turn on the calculator. It is the screen where you can perform operations such as adding numbers. You can always return to the main screen by pressing . Other screens will be discussed below according to their use.

The buttons There are three levels of buttons. The physical buttons together with the green and blue print above each button, for example . To select the items in green (blue) print first select () then the button beneath the printed item. For example to select the letter K press then .
From now on we will use 'button' to mean any of the the physical buttons or the green or blue pseudo-buttons.

The clear button Whenever you want to erase a line of input or a screen press the button (once or twice).

The delete and insert buttons The 'DEL' button ($\boxed{\text{del}}$) and the 'INS' button ($\boxed{2\text{nd}} \boxed{\text{del}}$) are handy when editing an expression. The 'DEL' button just deletes the character that is at the location of the cursor. The insert button inserts the entered numbers or letters at the location of the cursor. For example, if you type 5+5 and you realize you wanted 15+5 instead, you should use the left arrow to move the cursor to the first 5, press $\boxed{2\text{nd}} \boxed{\text{del}} \boxed{1}$. What happens if you just had pressed $\boxed{1}$? Note that the calculator stays in 'insert mode' until the cursor is moved with the error or enter is pressed. So you could have changed the first 5 to a 115 by moving the cursor to the first 5 and pressing $\boxed{2\text{nd}} \boxed{\text{del}} \boxed{1} \boxed{1}$.

The ANS button The answer button is used when you want to use the answer above in an expression. For example suppose you had entered $\boxed{3} \boxed{+} \boxed{5} \boxed{\text{enter}}$. Now you want to compute 7 minus the result of that computation. You can press $\boxed{7} \boxed{-} \boxed{2\text{nd}} \boxed{(-)}$.

The ENTRY button The 'ENTRY' button (the blue selection above $\boxed{\text{enter}}$ which is entered by pressing $\boxed{2\text{nd}} \boxed{\text{enter}}$) displays the last entry. This is a particularly useful button when you have entered an expression then realized there is an error. You can recall the expression then edit it. Unlike the 'ANS' button, using 'ENTRY' twice gives the entry before the last. For example:

Example A.1. We first prepare the screen: $\boxed{5} \boxed{+} \boxed{5} \boxed{\text{enter}}$ $\boxed{2} \boxed{+} \boxed{2} \boxed{\text{enter}}$. Now press the 'ENTRY' button. 2 + 2 appears in the window. Press the 'ENTRY' button again. 5 + 5 replaces the 2 + 2.

5+5	10
2+2	4
5+5	

Press $\boxed{\text{enter}}$ (so that 10 is the answer). To multiply the 2+2 by 7 we

can enter: $\boxed{2\text{nd}} \boxed{\text{enter}} \boxed{2\text{nd}} \boxed{\text{enter}}$. Then move the cursor using the left arrow to the position of the first 2 and press $\boxed{2\text{nd}} \boxed{\text{del}}$ $\boxed{(}$. Then move the cursor using the right button to after the second 2 and press the sequence $\boxed{)} \boxed{\times} \boxed{7}$.

2+2	
5+5	4
(2+2)*7	10
	28
■	

What happens if we leave out the parentheses? Can we enter $\boxed{(}$ before $\boxed{2\text{nd}} \boxed{\text{enter}}$?

Example A.2. First type $\boxed{5} \boxed{+} \boxed{2} \boxed{\text{enter}}$.
 Then type $\boxed{2\text{nd}} \boxed{(-)} \boxed{+} \boxed{5} \boxed{\text{enter}}$,
 $\boxed{2\text{nd}} \boxed{\text{enter}} \boxed{\text{enter}}$,
 $\boxed{2\text{nd}} \boxed{\text{enter}} \boxed{\text{enter}}$.

5+2	
Ans+5	7
Ans+5	12
Ans+5	17
■	

What would have happened if you had used the 'ANS' button instead of the 'ENTRY' button?

Note that instead of the second $\boxed{2\text{nd}} \boxed{\text{enter}} \boxed{\text{enter}}$ you could have just pressed $\boxed{\text{enter}}$.

– **vs (-)** There are two minus signs on the keyboard: $\boxed{-}$ which is between $\boxed{\times}$ and $\boxed{+}$, and $\boxed{(-)}$ which is to the lower left of $\boxed{\text{enter}}$. What is the difference between the two? $\boxed{-}$ means subtract. So this is the button you use to compute $7 - 5$. The button $\boxed{(-)}$ means

'negative' or 'the opposite of' so, for example, if you want to compute $-5 + 7$ you enter $(-)$ 5 $+$ 7 . Notice what happens if you use $-$ instead (what will you subtract from?!). The $(-)$ button is also what you use to enter expressions like $-x + 7$ or $\exp(-x)$.

The MODE button When calculating using the trigonometric functions (sin, cos, tan, and their inverses) it is important that you distinguish between degrees and radians and that you are in sync with your calculator. For that we need to look at the MODE screen. To view the Mode screen press mode . The third line has the words Radian and Degree. If the word 'radian' is highlighted and you want to compute in degrees you should press the down arrow twice (so that the highlighted word on the third line blinks) and then the right arrow and press enter . The word 'degree' should then be highlighted.



You can also verify your mode by evaluating $\sin(180)$ on the main screen (you can press 'quit' - 2nd mode to return to the main screen). If you get 0 as an answer then you are in degree mode. What do you get if you are in radian mode?

The STO button When evaluating complicated expressions, sometimes it is handy to use the storage feature. For example

Example A.3. Suppose you want to evaluate $\frac{(1-(1-1/2))^2}{1-1/2}$. You can first assign a letter, V say, the value $(1 - 1/2)$ since it appears twice. You can do this by pressing 1 $-$ 1 \div 2 sto α 6 . Then to evaluate the original expression type $($ 1 $-$ α

$6 \quad) \quad x^2 \quad \div \quad \text{alpha} \quad 6 \quad .$

$1-1/2 \div V$.5
$(1-V)^2/V$.5

Example A.4. Note that you can use this feature with the 'ENTRY' button to evaluate a function at different places. Let's evaluate $x^2 + x$ at $x = 0$ and at $x = 1$.

First set $x = 0$: $0 \quad \text{sto} \quad X,T,\theta,n \quad \text{enter}$.

Then evaluate the function: $X,T,\theta,n \quad x^2 \quad + \quad X,T,\theta,n \quad \text{enter}$

Now set $x = 1$: $1 \quad \text{sto} \quad X,T,\theta,n$

Now evaluate the function again: $2\text{nd} \quad \text{enter} \quad 2\text{nd} \quad \text{enter} \quad \text{enter}$.

$0 \rightarrow X$	0	$1 \rightarrow X$	1
$X^2 + X$	0	$X^2 + X$	2

Note that there is another way to evaluate a function at several points which will be introduced below in the graphing section.

A.2 Graphing a function

The Y= screen This is the screen that we will need to graph functions. It is seen by pressing $y=$.

Plot1	Plot2	Plot3
$\sqrt{Y1} = \sin(X)$		
$\sqrt{Y2} =$		
$\sqrt{Y3} =$		
$\sqrt{Y4} =$		
$\sqrt{Y5} =$		
$\sqrt{Y6} =$		
$\sqrt{Y7} =$		

Press the $\boxed{y=}$ button. This brings you to the screen where you can enter functions that you want to graph. Let us suppose that you want to graph $y = \sin(x)$. You would first move the cursor (using the arrow keys) to 'Y1' enter $\boxed{\sin}$ $\boxed{X,T,\theta,n}$ $\boxed{\text{enter}}$. Then press $\boxed{\text{graph}}$. This will show a portion of the graph of the function (naturally, it can not generally show you the whole graph as this is often 'infinite').

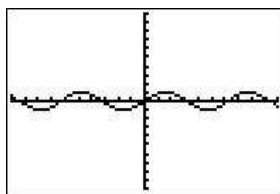

A.2.1 Rescaling the graphing window

The graphing window is what determines what portion of the graph is seen. There are various reasons you may want to have a different window. For example, the standard view for graphing the sin function (as we will show in the next paragraph) the setting for the y -axis is too large and makes it difficult to see what is going on. We describe here a few using the example of $\sin(x)$ (in degree mode) and encourage experimenting.

The standard window This sets the x -axis from -10 to 10 and the y -axis from -10 to 10 . To choose this view you must choose the standard window from the 'ZOOM' screen by pressing $\boxed{\text{zoom}}$ $\boxed{6}$. This is the window shown above.

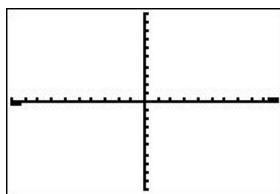

Notice that in this case you can't really see what you want. Don't worry, there are other zooming options!

Zoom fit One easy way to 'choose' an appropriate window is to ask the calculator to choose it using the 'zoom fit' windows ($\boxed{\text{zoom}}$ $\boxed{0}$). You

can also press then press the down arrow until you arrive at the bottom of the list with is 'ZoomFit'.

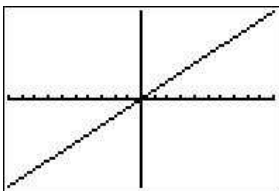

Custom window Maybe the zoom fit choice of the calculator isn't what you wanted to see. Then you can choose your own window. Press the key. Move the cursor to Xmin. This is the smallest number on the x -axis in your custom window. let's say you want this to be -5 . Then you press . Then move the cursor to Xmax and enter your desired maximum, say, . You can also adjust the scale (where the marks on the x -axis are given) by setting Xscl equal to whatever is convenient. In this example we will set it to 1. Now you can do the same for the y -axis with changing Ymin and Ymax to say, and , respectively. Press graph again and observe the window.

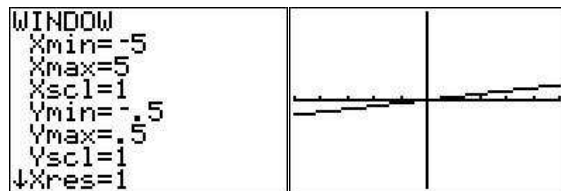

Zooming in and out You can zoom in and out also. Press the . You will now be looking at the graph. Move your cursor to what you want to be the center and press . You can zoom out as well.

ZTrig The best choice for our current $Y1=\sin(X)$ function is ZTrig (press

zoom **7**).

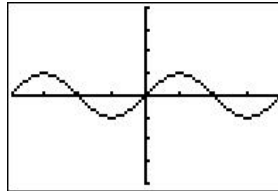

Zbox You should experiment with ZBox, which is the first option on the zoom menu. You first move the cursor to where you want the upper left point of your box to be and press enter. Then you move the cursor to where you want your lower right corner to be and press enter. Our result is

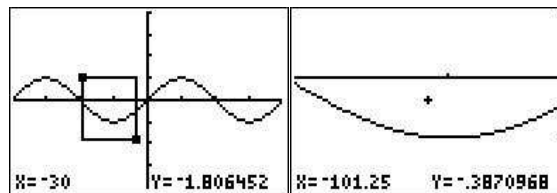

ZSquare Finally, we point out another zoom option, the zoom square option, which scales the x - and y -axes to the same pixel size. To see the issue recall from example 4.4 on page 52, that the circle $x^2 + y^2 = 16$ may be graphed by entering the functions $y = \pm\sqrt{16 - x^2}$.

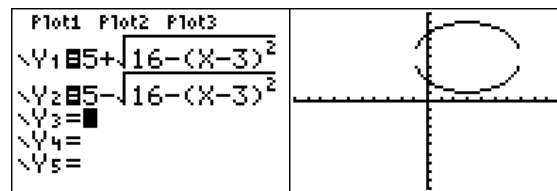

Note, that the obtained graph in the above window (with $-6 \leq x \leq 6$ and $-6 \leq y \leq 6$) looks more like an ellipse rather than a circle. To rectify this, we press **zoom** **5** , and obtain a graph which now does have the

shape of a circle.

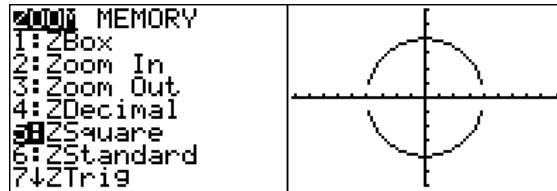

A.3 Graphing more than one function

Let us suppose that you want to graph three functions: $y = \sin(360x)$, $y = x$ and $y = x - \frac{x^3}{6}$. You would first move the cursor (using the arrow keys) to 'Y1' enter . Note that if you need to clear the field you can use the clear button. Then you would move the cursor to the 'Y2' position and enter . Finally you would move the cursor to the 'Y3' position and enter . To graph these functions press . The three graphs will be drawn one after the other.

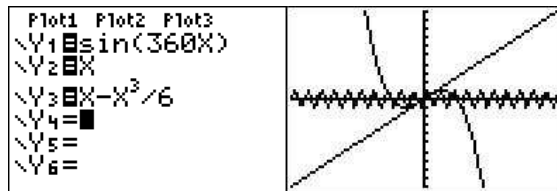

If you would like to just graph the first two but do not want to erase the work you put in to enter the third function, you can move back to the screen and toggle the third function off (or on) by moving the cursor to the '=' sign after Y3 and press . This equal sign should now be unhighlighted.

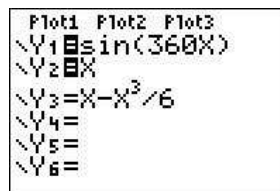

You may also want to have the calculator distinguish between the graphs by the type of line. Let us suppose you want Y1 bold, Y2 normal, and Y3 dashed. Look at the ' to the left of Y1. This is what indicates the type of line. Press until the line type you want is displayed. Move the cursor down and do the same for Y2 and then for Y3.

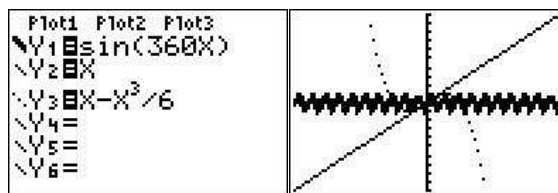

The Calc menu With the help of the Calc menu () you can find the minima of a function, the maxima of a function, intersections of functions, and other similar things. We will describe the intersection feature in detail.

Intersection of functions When solving equations graphically, you will want to find the intersection of functions. For example graph $y = x^2$ and $y = x + 2$ on the same screen (zoom standard).

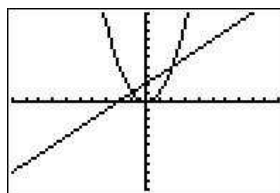

To find the left most intersection of the two functions first press . The calculator shows you the graphing screen and will ask you which is the first curve. Move the cursor (using the arrow keys) until it is on the first curve and press . It will ask you which is the second curve. Move the cursor to the second curve and press .

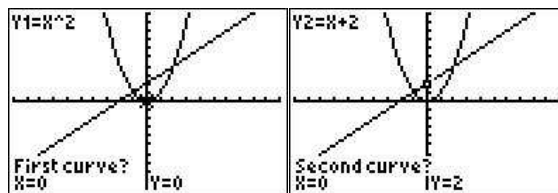

It will ask you for a guess. Move the cursor to near the intersection point you want to know and press . The intersection will then be displayed.

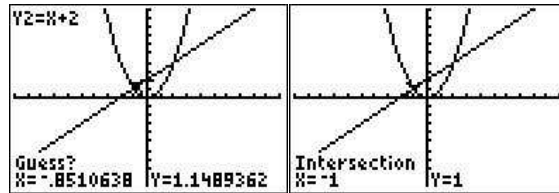

A.4 Graphing a piecewise defined function

Suppose you wanted to graph the piecewise defined function

$$f(x) = \begin{cases} x^2, & x < 2 \\ 2x - 7, & x \geq 2 \end{cases}$$

Go to the menu. We need to enter the function in the following way:

$$y = x^2(x < 2) + (2x - 7)(x \geq 2)$$

The only new entries are in the inequality signs, which can be accessed through the “TEST” menu ().

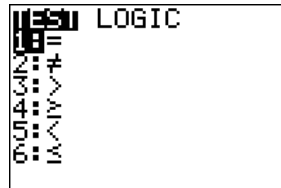

Therefore, we press the keys:

. The graph is displayed on the right:

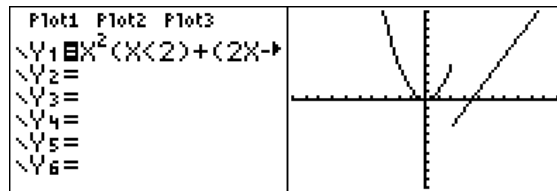

The meaning of $y = (x < 2)$ as a function is that it is equal to 1 when it is true and 0 when it is false. In other words, the expression $(x < 2)$ is 1 when $x < 2$ and 0 otherwise. You can use this idea to graph more complicated functions. For example to enter $x + 2$ for $0 < x < 3$ you could enter $(x + 2)(0 < x)(x < 3)$.

Note: When graphing piecewise defined functions the graph is sometimes different from what is expected. See the common errors section to interpret the resulting graph below.

Graphing with polar coordinates Suppose you want to graph the curve $r = \theta + \sin \theta$. Press . On the fourth line highlight 'Pol' and press (make sure you in radian mode also)



and press . Your menu will have a list r_1, r_2, \dots . After r_1 type . Then to see the graph type . You may have to adjust your window (zoom fit) to see the resulting spiral.

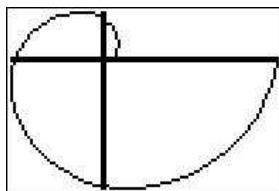

Graphing with parametric coordinates Suppose you want to graph the curve given by $y(t) = 3 \sin(t), x(t) = 4 \cos(t)$. First we need to set the mode to parametric mode: press and highlight 'PAR' in the fourth line and

press .

```

NORMAL SCI ENG
FLOAT 0 1 2 3 4 5 6 7 8 9
RADIAN DEGREE
FUNC PAR POL SEQ
CONNECTED DOT
SEQUENTIAL SIMUL
REAL a+bi r<math>e^{i\theta}</math>
FULL HORIZ G-T
↓NEXT↓

```

Now go to the graphing screen . You will see a list that begins with X_{1T} and Y_{1T} . To the right of X_{1T} type and to the right of Y_{1T} type . Then to see the graph press . You may need to (zoomfit) to see the resulting ellipse. (Also, be aware that the scale may be misleading– you may want to for a clearer understanding of the graph).

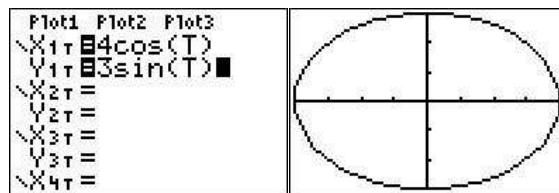

A.5 Using the table

The table () is useful as it gives a table representation of a function (from the screen). Make sure there is a function typed in the Y_1 position and look at the table. If you want to know the value of the function for particular values of x then we must use the 'TBLSET' screen. Press . Move the cursor to the 'Indpnt' line then to the right to highlight ask and press .

```

TABLE SETUP
TblStart=0
ΔTbl=1
Indent: Auto [ON]
Depend: [OFF] Ask

```

Go back to the table (). Now your table is empty. Evaluate your function at 2.5 by typing 2.5 and pressing (). You will see the value of the function in Y1 at 2.5 in the table now. You can evaluate at any number of points.

X	Y1	
2.5	6.25	
5	25	
X=5		

You can also evaluate at every half integer starting at -1 for example by going to the 'TBLSET' screen () changing 'TblStart' to () and Δ Tbl= .5. Also change the 'Indpnt' setting to 'Auto' again.

TABLE SETUP	
TblStart=0	
Δ Tbl=.5	
Indpnt: AUTO	Ask
Depend: AUTO	Ask

View the table () to see what happened.

A.6 Solving an equation using the solver

We now solve the equation $x^2 = 2$. The first thing we must do in order to use the equation solver is to rewrite the equation as an expression equal to zero, that is we need to write it in the format 'something= 0.' In our example this will be $x^2 - 2 = 0$. Now, let's go to the equation solver. Press () and use the cursor to go to the bottom of the list and press enter when 'Solver...' is highlighted. Various things appear on the screen. Press the up arrow () until 'EQUATION SOLVER' appears on the top line. Edit the right hand side of the equation on the second line so that it reads ' $0 = x^2 - 2$ ' and press

A.7. SPECIAL FUNCTIONS (ABSOLUTE VALUE, N -TH ROOT, ETC.) 363

.

```
EQUATION SOLVER
eqn: 0=X^2-2
```

Next, on the second line pick a number near where you expect the answer to be, for example, ' $x = 1$ '.

```
X^2-2=0
X=1
bound=(-1E99,1...
```

Now solve by pressing . The second line gives an answer (check that it is a square root of two!).

```
X^2-2=0
■ X=1.4142135623...
bound=(-1E99,1...
■ left-rt=0
```

What happens if you had entered ' $x = -1$ ' on the second line (use here)?

A.7 Special functions (absolute value, n -th root, etc.)

We now point out some important functions in the MATH menu () and the LIST menu () , that are used in this course.

Fractions Suppose in the main screen you evaluate $4/6$. Your calculator will display .66666666667. If you wanted to see this as a fraction you would type . You will now see $2/3$ displayed.

Absolute value To evaluate $|-4|$ you would type in the main screen $\boxed{\text{math}}$ $\boxed{\triangleright}$ $\boxed{\text{enter}}$ $\boxed{(-)}$ $\boxed{4}$ $\boxed{\text{enter}}$. The answer 4 should be displayed. To graph $|x - 2|$, go to the Y= screen ($\boxed{y=}$) and enter in the Y1 (for example) space $\boxed{\text{math}}$ $\boxed{\triangleright}$ $\boxed{\text{enter}}$ $\boxed{X,T,\theta,n}$ $\boxed{-}$ $\boxed{2}$ $\boxed{\triangleright}$ $\boxed{\text{enter}}$.



Now you can go to the graphing screen to see the graph.

n -th root To calculate the cube root of 8. Press on the main screen $\boxed{3}$ $\boxed{\text{math}}$ $\boxed{5}$ (or select the x-root) $\boxed{8}$ $\boxed{\text{enter}}$.

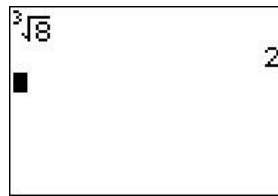

You can compute any root this way (e.g. the 5th root of 7). For the cube root you can also use $\boxed{\text{math}}$ $\boxed{4}$ instead. Recall also the algebraic definition of the n th root,

$$\sqrt[n]{x} = x^{\frac{1}{n}},$$

so that the 5th root of 7 can also be computed by pressing $\boxed{7}$ $\boxed{\wedge}$ $\boxed{(}$ $\boxed{1}$ $\boxed{\div}$ $\boxed{5}$ $\boxed{)}$.

Factorials To compute $5!$, for example, in the main screen type $\boxed{5}$ $\boxed{\text{math}}$ then move the cursor to the right three times (or left once) so that the 'PRB' menu is displayed. Option 4 is '!' so press $\boxed{4}$ or move the cursor to highlight this option and press $\boxed{\text{enter}}$. Finally press $\boxed{\text{enter}}$.

A.7. SPECIAL FUNCTIONS (ABSOLUTE VALUE, N -TH ROOT, ETC.) 365

and the answer 120 will be displayed.

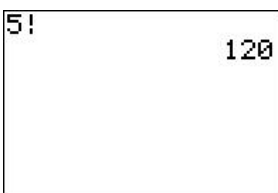

Combinations and permutations To calculate ${}_5C_2 = \binom{5}{2}$, in the main menu type . Then go to the math-probability menu by pressing then the right (or left) arrow until 'PRB' is highlighted. You will see that the third option is ${}_nC_r$ so press . This will return you to the main screen. Press . The answer 10 will be displayed.



Permutations ${}_nP_r$ are handled the same way except it is the second option under the math-probability menu instead of the third.

Sequences and series A sequence a_1, a_2, a_3, \dots that is given by a formula can be added via the 'LIST' menu (press). For example, to enter the first 10 terms a_1, a_2, \dots, a_{10} of the sequence $a_n = n^2 + 1$, we have to write $seq(x^2 + 1, x, 1, 10)$. Here, the 'sequence' command takes four inputs, first the assignment $x^2 + 1$, second the independent variable x , third the starting index 1, and fourth the final index 10. This expression is entered to the calculator by pressing

) and then confirmed by pressing **enter**. We obtain:

```
seq(X^2+1,X,1,10)
(2 5 10 17 26 37
█
```

To add the ten numbers $a_1 + \dots + a_{10}$ of the sequence, we use the 'sum' command in the LIST-MATH menu. Press **2nd** **stat** **<** **5** to enter the 'sum(' expression. Then using the previously entered answer by pressing **2nd** **(-)**, and finishing with **)** **enter**, we now calculate the wanted sum.

```
seq(X^2+1,X,1,10)
(2 5 10 17 26 37
sum(Ans)
395
█
```

A.8 Programming the calculator

This section is more advanced and is only recommended for students who are familiar with programming languages.

Hello world A 'Hello World' program is a program that only displays the words "Hello World." It is a starting point to understand the procedure of creating and running a program before going to more advanced programming techniques.

To create a new program press **prgm**, move to the right **>** to 'NEW,' and give it the name 'HELLO.'

```
EXEC EDIT NEW
█
```

```
EXEC EDIT NEW
Create New
█
```

```
PROGRAM
Name=HELLO
█
```

Next, we need to add the Display command. Press `prgm`; you see a list of commands. We move to the right to 'I/O' for input/output commands. Select the third item 'Disp' for display.

PROGRAM:HELLO :	I/O EXEC 1:If 2:Then 3:Else 4:For(5:While 6:Repeat 7↓End	CTL I/O EXEC 1:InPut 2:PromPt 3:Disp 4:DispGraph 5:DispTable 6:Output(7↓getKey
--------------------	---	---

To finish, we need to add "HELLO WORLD." (Quotation marks obtained by pressing `alpha` `+`; space is obtained by `alpha` `0`.) The complete program is shown below.

```
PROGRAM:HELLO
:Disp "HELLO WOR
LD"
:
```

To execute the program, quit `2nd` `mode`, press `prgm` and confirm with `enter`. After another `enter`, the program should run as shown below.

EXEC EDIT NEW 1:HELLO	Pr9mHELLO HELLO WORLD Done █
---------------------------------	---------------------------------------

The quadratic formula We next implement the quadratic formula

$$ax^2 + bx + c = 0 \implies x = \frac{-b \pm \sqrt{b^2 - 4ac}}{2a}.$$

Create a new program 'QUADRATI.' We now need a new command, the Prompt command which will ask for three input values and places them in the variables

A, B, C. The Prompt command is the second item in the 'I/O' menu.

<pre>PROGRAM:QUADARTI :Prompt A,B,C :Disp (-B+√(B²-4 AC))/2A) :Disp (-B-√(B²-4 AC))/2A) :</pre>	<pre>CTL I/O EXEC 1:Input 2:Prompt 3:Disp 4:DispGraph 5:DispTable 6:Output(7:↓getKey</pre>
---	---

After executing the new program, enter any input values (for example $A = 3$, $B = -10$, $C = -8$). The answer should appear below.

<pre>EDIT NEW 1:HELLO 2:QUADARTI</pre>	<pre>PrgrMQUADARTI A=?3 B=?-10 C=?-8</pre>	<pre>A=?3 B=?-10 C=?-8 4 -.6666666667 Done</pre>
--	--	--

Directional angle Our third and last program calculates the directional angle of a vector $\vec{v} = \langle a, b \rangle$. Recall that the angle is $\tan^{-1}(b/a)$ or $\tan^{-1}(b/a) + 180^\circ$ depending on the quadrant in which \vec{v} is pointing. In quadrant II and III, we need to add 180° degrees. This is exactly the case when $a < 0$. Thus, we prompt for input values A and B, and we calculate $\tan^{-1}(b/a)$ and place it into the new variable G. (The arrow is obtained by pressing `sto`.) We then check if $a < 0$, in which case we add 180 to G. (Here, we are assuming that the calculator is in degree mode).

<pre>PROGRAM:ANGLE :Prompt A,B :tan⁻¹(B/A)→G :If A<0 :G+180→G :Disp G :</pre>	<pre>I/O EXEC 1:If 2:Then 3:Else 4:For(5:While 6:Repeat 7:↓End</pre>	<pre>LOGIC 1:= 2:≠ 3:> 4:≥ 5:< 6:≤</pre>
--	---	--

Note that the 'If' command is obtained by pressing `prgm`, and '<' is obtained from the TEST menu, press `2nd` `math` and then `5`.

We may now run the program and check its correctness in some examples.

<pre> Pr9mANGLE A=?3 B=?3 45 Done </pre>	<pre> Pr9mANGLE A=?-3 B=?3 135 Done </pre>
--	--

Other projects Here is a list of projects that you may want to try to implement on your calculator.

1. Display the final amount of an investment for a given principal P , annual interest rate r , number of compoundings per year n , and number of years t (see Observation 16.8 on page 222).
2. In the program above for the directional angle, check for the cases when $a = 0$, and display the correct answers.
3. Implement the long division (see Session 8).

Erasing a program To erase a program that you have written, press , then , then . A list of all your programs appears.

<pre> 01:0033 1:About 2:Mem Mgmt/Del... 3:Clear Entries 4:ClrAllLists 5:Archive 6:UnArchive 7:Reset... </pre>	<pre> RAM FREE 24177 ARC FREE 287922 1:All... 2:Real... 3:Complex... 4>List... 5:Matrix... 6:Y-Vars... </pre>	<pre> RAM FREE 24142 ARC FREE 287922 HELLO 29 L1 12 L2 12 L3 12 L4 12 L5 12 </pre>
---	--	--

Select the program you want to delete with and press the key. Confirm your selection with 'Yes.'

```

Are You Sure?
1:No
2:Yes

```

A.9 Common errors

The following shows many common errors and mistakes that may produce a false result or an error. If none of the items below help to resolve your problem, then you can also reset the calculator to factory setting (see section A.10 on page 373).

Reset window to standard window Many problems with graphing can be resolved by changing the window back to the standard window. To do so, press .

```

ZOOM MEMORY
1:ZBox
2:Zoom In
3:Zoom Out
4:ZDecimal
5:ZSquare
6:ZStandard
7:ZTrig
  
```

Note, that the standard window has the following settings:

```

WINDOW
Xmin=-10
Xmax=10
Xscl=1
Ymin=-10
Ymax=10
Yscl=1
Xres=1
  
```

PLOT marked Sometimes an error is produced when graphing a function due to having any of the PLOTS marked in the 'Y=' menu.

Plot1	Plot2	Plot3
<input checked="" type="checkbox"/>	<input type="checkbox"/>	<input type="checkbox"/>
Y1=X ²		
Y2=		
Y3=		
Y4=		
Y5=		
Y6=		

Plot1	Plot2	Plot3
<input type="checkbox"/>	<input type="checkbox"/>	<input type="checkbox"/>
Y1=X ²		
Y2=		
Y3=		
Y4=		
Y5=		
Y6=		

Make sure that all of the PLOTS are *unmarked*!

Errors in graphing functions Graph the functions $y = \ln(x-3)$ or $y = \frac{1}{x^3-9x}$.

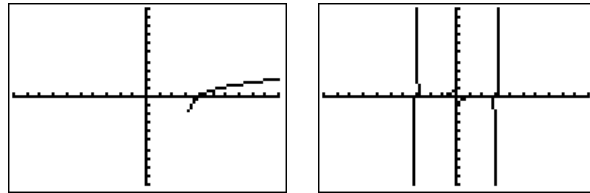

The calculator graphic is not really the graph, but has extra parts or missing parts of the graph (depending on the version of the calculator: TI-83 is much worse than TI-84). The reason for this is that the calculator just approximates the graph pixel by pixel and does *not* represent the exact graph. In particular, you should *not* just copy the graph from the calculator onto your paper, but *interpret* what you see and draw the *interpreted* graph!

Fractions need parenthesis for numerator and denominator When entering a rational function, (or any fraction), the numerator and denominator has to be entered with parenthesis. For example, $y = \frac{x-3}{x^2-1}$ is entered as follows.

```

Plot1 Plot2 Plot3
Y1=(X-3)/(X^2-1)
Y2=
Y3=
Y4=
Y5=
Y6=

```

Radian versus degree Trigonometric functions should generally be graphed in radians. For example, the cosine function in radian gives the following.

```

NORMAL SCI ENG
FLOAT 0 1 2 3 4 5 6 7 8 9
RADIAN DEGREE
FUNC PAR POL SEQ
CONNECTED DOT
SEQUENTIAL SIMUL
REAL a+bi P&^Q
FULL HORIZ G-T
↓NEXT↓

```

```

Plot1 Plot2 Plot3
Y1=cos(X)
Y2=
Y3=
Y4=
Y5=
Y6=
Y7=

```

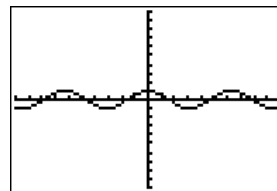

On the other hand, the cosine in degrees displays as follows.

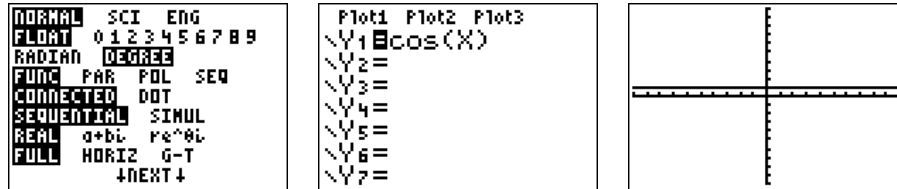

The reason is that one period is now 360 on the x -axis. Rescaling the calculator to a wider x -scale shows the effect more clearly.

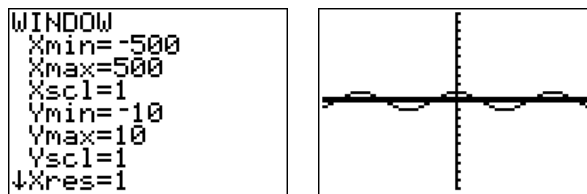

The calculator also gives different values for the trigonometric functions in degrees or radians. This is shown below.

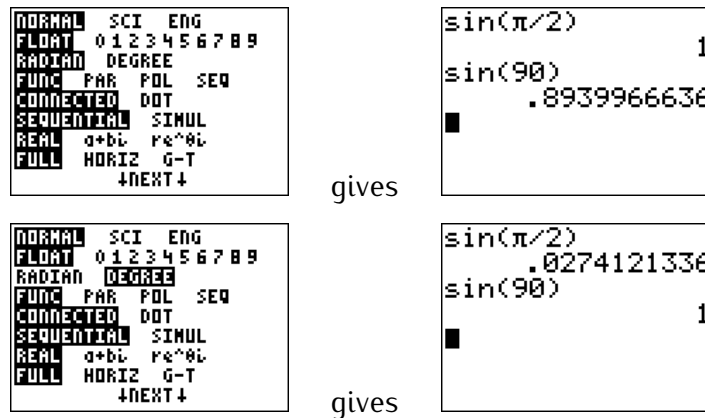
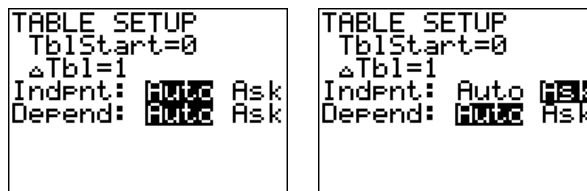
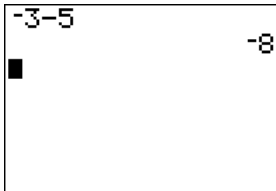

Table setup The table can be setup to generate a list of outputs, or to take an input value and generate its output value. This depends on the independent variable in the TABLE SETUP being set to 'Auto' or 'Ask,' respectively.



Using the wrong minus sign Often a syntax error is due to using the minus sign instead of . Note that is used to *subtract* two numbers, whereas gives the *negative* of a number.

For example, to calculate $-3 - 5$, press .



A.10 Resetting the calculator to factory settings

To reset everything and return the calculator to factory settings, first press the buttons to get to the MEMORY menu, and then ('Reset...').



Then move the cursor to the right (with) until 'ALL' is highlighted. Press ('All Memory...') and ('Reset').

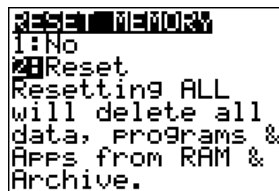

(With some of the other options in the MEMORY/Reset... menu you can also reset selective parts of the calculator only.)

Answers to exercises

Here are the answers to the exercises given in each sections and in the reviews for each part.

Session 1 (exercises starting on page 11):

Exercise 1.1 Examples: a) 2, 3, 5, b) $-3, 0, 6$, c) $-3, -4, 0$, d) $\frac{2}{3}, \frac{-4}{7}, 8$, e) $\sqrt{5}, \pi, \sqrt[3]{31}$, f) $\frac{1}{2}, \frac{2}{5}, 0.75$







Exercise 1.2 natural: $17000, \frac{12}{4}, \sqrt{25}$, integer: $-5, 0, 17000, \frac{12}{4}, \sqrt{25}$, rational: $\frac{7}{3}, -5, 0, 17000, \frac{12}{4}, \sqrt{25}$, real: all of the given numbers are real numbers, irrational: $\sqrt{7}$

Exercise 1.3 a) 8, b) 10, c) 99, d) -3 , e) -2 , f) $\sqrt{6}$, g) 7, h) 7, i) 5.4, j) $\frac{2}{3}$, k) $\frac{5}{2}$, l) -2

Exercise 1.4 a) $S = \{-8, 8\}$, b) $S = \{0\}$, c) $S = \{\}$, d) $S = \{-13, 7\}$, e) $S = \{-7, 2\}$, f) $S = \{-4, \frac{24}{5}\}$, g) $S = \{\}$, h) $S = \{\frac{-3}{7}\}$, i) $S = \{-10, 12\}$, j) $S = \{\frac{-4}{3}, \frac{8}{3}\}$, k) $S = \{-8, 1\}$, l) $S = \{-10, 2\}$

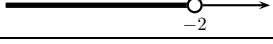
Exercise 1.5 a) $S = \{-8, 8\}$, b) $S = \{0\}$, c) $S = \{\}$, d) $S = \{2, 6\}$, e) $S = \{-14, 4\}$, f) $S = \{-3, 7\}$

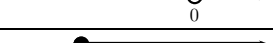
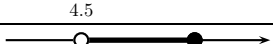
Exercise 1.6

Inequality	Number line	Interval
$2 \leq x < 5$		$[2, 5)$
$x \leq 3$		$(-\infty, 3]$
$12 < x \leq 17$		$(12, 17]$
$x < -2$		$(-\infty, -2)$
$-2 \leq x \leq 6$		$[-2, 6]$
$x < 0$		$(-\infty, 0)$
$4.5 \leq x$		$[4.5, \infty)$
$5 < x \leq \sqrt{30}$		$(5, \sqrt{30}]$
$\frac{13}{7} < x < \pi$		$(\frac{13}{7}, \pi)$

- Exercise 1.7 a) $S = [-3, 11]$, b) $S = (-\infty, -3] \cup [11, \infty)$, c) $S = (-\infty, -3) \cup (11, \infty)$,
 d) $S = [-10, 3]$, e) $S = (-\infty, -\frac{5}{2}) \cup (\frac{3}{2}, \infty)$, f) $S = (\frac{-19}{4}, \frac{15}{4})$, g)
 $S = (-\infty, 3] \cup [7, \infty)$, h) $S = (-\infty, \frac{2}{15}) \cup (\frac{2}{5}, \infty)$, i) $S = [-1, 3]$, j)
 $S = \{\}$, k) $S = (-\infty, \infty) = \mathbb{R}$, l) $S = (-\infty, -1) \cup (-1, \infty) = \mathbb{R} - \{-1\}$

Session 2 (exercises starting on page 28):

- Exercise 2.1 a) $y = 2x - 4$, b) $y = -x + 3$, c) $y = -2x - 2$, d) $y = \frac{2}{5}x + 3$, e)
 $y = -x + 0$ or $y = -x$, f) $y = \frac{2}{3}x + 4$
- Exercise 2.2 a) $y = -2x + 4$, b) $y = 3x + 5$, c) $y = -\frac{1}{2}x - 2$, d) $y = \frac{3}{5}x - \frac{7}{5}$, e)
 $y = \frac{3}{2}x - \frac{15}{2}$, f) $y = \frac{8}{9}x$
- Exercise 2.3 a) $y - 3 = \frac{1}{3} \cdot (x - 5)$, b) $y - 1 = -\frac{3}{2} \cdot (x - 4)$, c) $y + 2 = -\frac{1}{2} \cdot (x - 3)$,
 d) $y - 1 = 1 \cdot (x + 1)$

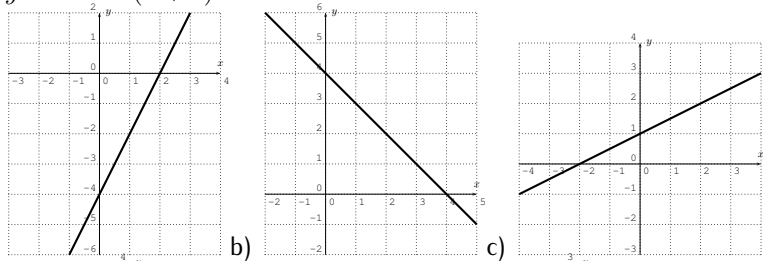

Exercise 2.4

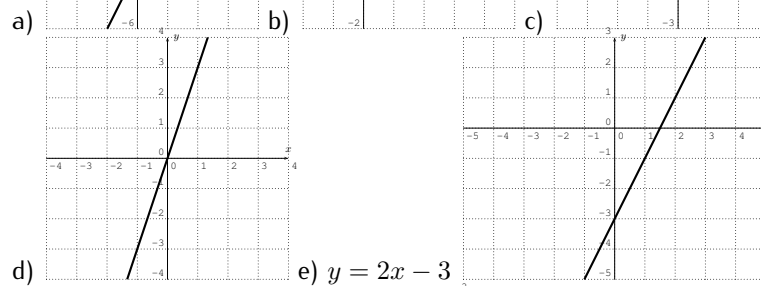

d) $y = 2x - 3$

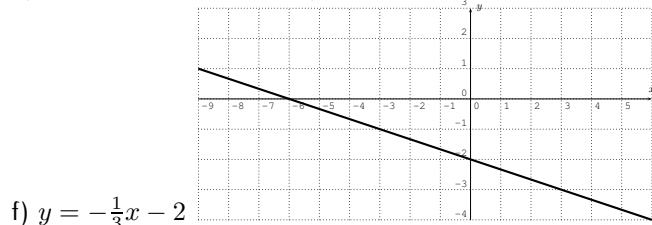

f) $y = -\frac{1}{3}x - 2$

- Exercise 2.5 a) this is a function with domain $D = \{-5, -1, 0, 3, 6\}$ and range
 $R = \{2, 3, 5, 7, 8\}$, for example: the input $x = -5$ gives output $y = 5$,
 etc., b) not a function since for $x = 4$ we have both $y = 0$ and $y = -1$,
 c) this is a function with $D = \{-11, -2, 3, 6, 7, 19\}$, $R = \{3\}$, d) this is
 a function with $D = \{1, 2, 3, 4, 5\}$, $R = \{\sqrt{19}, 5.33, 9, 13, 17\}$, e) this is
 not a function

- Exercise 2.6 a) yes, b) no, c) the domain for the function in (a) is the set of all
 children, d) the range for the function in (a) is the set of all mothers

- Exercise 2.7 a) a given cash amount x determines the interest amount y , b) i) \$0,
 ii) \$100,000, iii) \$0, iv) \$300,000, v) \$200,000, vi) \$40,000

- Exercise 2.8 a) $C = 2\pi r$, b) $P = 3a$, c) $P = 2a + 6$, d) $V = a^3$

Session 3 (exercises starting on page 44):

- Exercise 3.1 a): i) 10, ii) 16, iii) -5 , iv) 1, v) $3\sqrt{13} + 1$, vi) $3\sqrt{2} + 10$, vii) $-3x + 1$, viii) $3x + 7$, ix) $3x + 1 + h$, x) $3x + 3h + 1$
- b): i) 6, ii) 20, iii) 6, iv) 0, v) $13 - \sqrt{13}$, vi) $8 + 5\sqrt{2}$, vii) $x^2 + x$, viii) $x^2 + 3x + 2$, ix) $x^2 - x + h$, x) $x^2 + 2xh + h^2 - x - h$
- c): i) 0, ii) 4, iii) undefined, iv) undefined, v) 2, vi) $\sqrt{2 + 6\sqrt{2}}$, vii) $\sqrt{x^2 - 9}$, viii) $\sqrt{x^2 + 4x - 5}$, ix) $\sqrt{x^2 - 9} + h$, x) $\sqrt{x^2 + 2xh + h^2 - 9}$
- d): i) $\frac{1}{3}$, ii) $\frac{1}{5}$, iii) $-\frac{1}{2}$, iv) undefined, v) $\frac{\sqrt{13}}{13}$, vi) $\frac{3-\sqrt{2}}{7}$, vii) $-\frac{1}{x}$, viii) $\frac{1}{x+2}$, ix) $\frac{1+xh}{x}$, x) $\frac{1}{x+h}$
- e): i) $\frac{-2}{5}$, ii) 0, iii) undefined, iv) $\frac{-5}{2}$, v) $\frac{\sqrt{13}-5}{\sqrt{13}+2} = \frac{23-7\sqrt{13}}{9}$, vi) $\frac{\sqrt{2}-2}{\sqrt{2}+5} = \frac{-12+7\sqrt{2}}{23}$, vii) $\frac{-x-5}{-x+2}$, viii) $\frac{x-3}{x+4}$, ix) $\frac{x-5+hx+2h}{x+2}$, x) $\frac{x+h-5}{x+h+2}$
- f): i) -27 , ii) -125 , iii) 8, iv) 0, v) $-\sqrt{2197}$, vi) $-45 - 29\sqrt{2}$, vii) x^3 , viii) $f(x+2) = -(x+2)^3$ or in descending order $f(x+2) = -x^3 - 6x^2 - 12x - 8$, ix) $-x^3 + h$, x) $-(x+h)^3$ or $-x^3 - 3x^2h - 3xh^2 - h^3$
- Exercise 3.2 a) $D = (-4, 6]$, b) -3 , c) 25, d) -8 , e) 9
- Exercise 3.3 a) $D = (-\infty, 5) \cup (5, \infty)$ or, alternatively, $D = \mathbb{R} - \{5\}$, b) 0, c) -2 , d) 7, e) 7, f) undefined, g) 22
- Exercise 3.4 a) 5, b) 2, c) $2x + h$, d) $2x + 5 + h$, e) $2x + 3 + h$, f) $-2x - h$, g) $2x + 4 + h$, h) $6x - 2 + 3h$, i) $3x^2 + 3xh + h^2$
- Exercise 3.5 a) 3, b) 4, c) $x + a - 3$, d) $\frac{-1}{ax}$
- Exercise 3.6 a) $D = \mathbb{R}$ all real numbers, b) $D = \mathbb{R}$, c) $D = [2, \infty)$, d) $D = (-\infty, 4]$, e) $D = \mathbb{R}$, f) $D = \mathbb{R} - \{-6\}$, g) $D = \mathbb{R} - \{7\}$, h) $D = \mathbb{R} - \{2, 5\}$, i) $D = \mathbb{R} - \{2\}$, j) $D = (1, 2) \cup [3, \infty)$, k) $D = [0, 9) \cup (9, \infty)$, l) $D = (-4, \infty)$
- Exercise 3.7 a) domain $D_f = [1, 3) \cup [4, 6]$ and range $R_f = [1, 3]$, b) $D_g = \mathbb{R}$ and $R_g = [2, 3]$, c) $D_h = (-2, 0) \cup (0, 2) \cup (2, 3)$ and $R_h = \{-1\} \cup (0, 1]$, d) 1, e) 3, f) undefined, g) 2, h) 2, i) 3, j) undefined, k) 2, l) 2, m) 3, n) 2.5, o) 2, p) 2, q) 2, r) undefined, s) 1, t) undefined, u) -1 , v) undefined, w) undefined, x) -1
- Exercise 3.8 a) not a function, b) this is a function, c) not a function, d) not a function
- Exercise 3.9 a) $D = (-3, 4) \cup (4, 7]$, b) $R = (-2, 2]$, c) $x = -2$ or $x = 0$ or $x = 7$, d) $x \in (4, 5]$, e) $x \in (-3, -1] \cup [0, 4) \cup [6, 7]$, f) $x \in (-2, 0) \cup (4, 7)$, g) $f(2) = -1$, $f(5) = 2$, h) $f(2) + f(5) = 1$, i) $f(2) + 5 = 4$, j) $f(2 + 5) = 0$
- Exercise 3.10 a) Approximately 3,900 students were admitted in the year 2000, b) The most students were admitted in 2007. c) In 2000, the number of admitted students rose fastest. d) In 2003 the number of admitted students declined.

Exercise 3.11 domain $D = (-2, 5]$, graph:

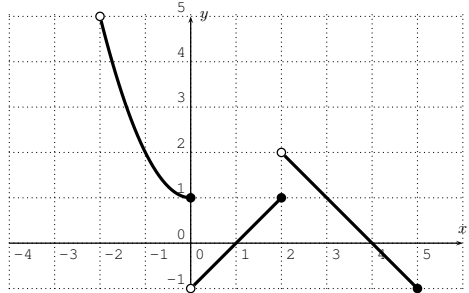

Session 4 (exercises starting on page 61):

Exercise 4.1

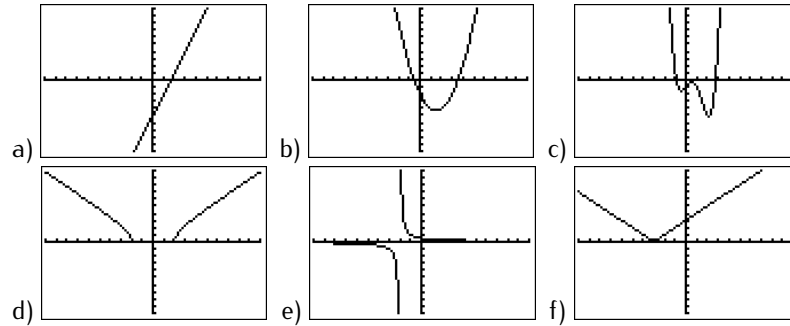

Exercise 4.2

a) $y_1 = \sqrt{4-x^2}$, $y_2 = -\sqrt{4-x^2}$ (The graphs are displayed below.) b) $y_1 = \sqrt{15-(x+5)^2}$, $y_2 = -\sqrt{15-(x+5)^2}$, c) $y_1 = 2 + \sqrt{9-(x-1)^2}$, $y_2 = 2 - \sqrt{9-(x-1)^2}$, d) $y_1 = \sqrt{-x^2+8x+14}$, $y_2 = -\sqrt{-x^2+8x+14}$, e) $y_1 = \sqrt{x^2+3}$, $y_2 = -\sqrt{x^2+3}$, f) $y_1 = \sqrt{-x^2+77}$, $y_2 = -\sqrt{-x^2+77}$

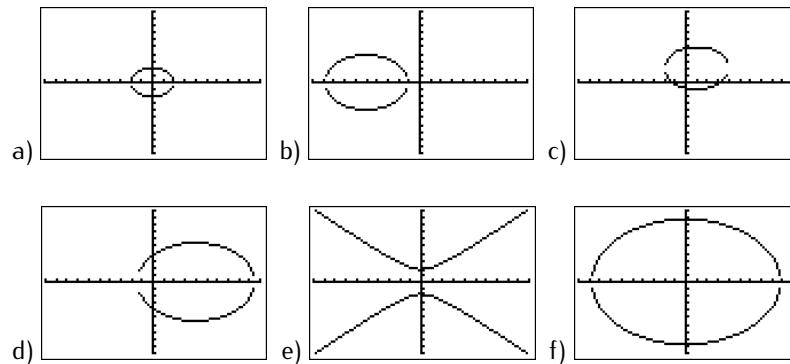

Exercise 4.3

a) $x \approx -2.62$, $x \approx -0.38$, b) $x = \pm 1$, $x = \pm\sqrt{2} \approx \pm 1.41$, c) $x \approx 1.46$, d) $x \approx -2.83$, $x \approx 0.01$, $x \approx 2.82$, $x \approx 4.01$, $x \approx 7.00$, e) $x \approx -0.578$, $x \approx 1.187$, $x \approx 4.388$, f) $x \approx 1.61$, $x = 2$, $x \approx 6.91$, g) $x \approx -4.00$, h) $x = -4$, $x = 2.25$, i) $x \approx -4.00$, $x \approx 2.22$, $x \approx 2.28$,

Exercise 4.4 a) $x \approx -1.488$, b) $x \approx -1.764$, $x \approx -0.416$, $x \approx 0.681$, c) $x \approx 5.220$, d) $x \approx -1.431$, $x \approx 0.038$, e) $x \approx -1.247$, $x = 0$, $x \approx 0.445$, $x \approx 1.802$, f) $x = 0$, $x = 1$, $x = 3$

Exercise 4.5 a) There is one minimum. Zoom out for the graph (see below). b) There is one maximum. Resize the window to $Y_{\min} = -100$. c) There is one local maximum and one local minimum. The graph with $X_{\min} = -4$, $X_{\max} = 4$, $Y_{\min} = -2$, $Y_{\max} = 2$ is below. d) Zooming into the graph reveals two local minima and one local maximum. We graph the function with $X_{\min} = -2$, $X_{\max} = 4$, $Y_{\min} = -1.3$, $Y_{\max} = 0.5$.

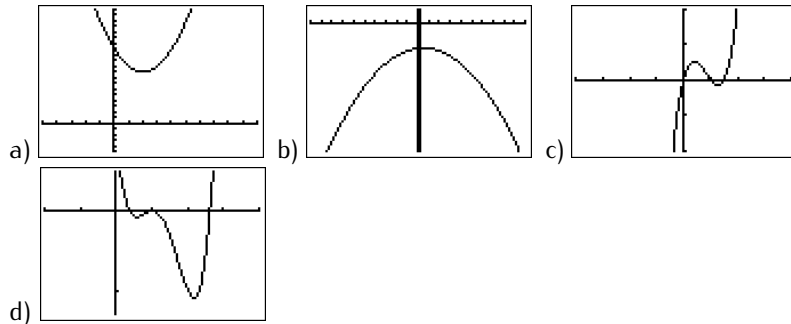

Exercise 4.6

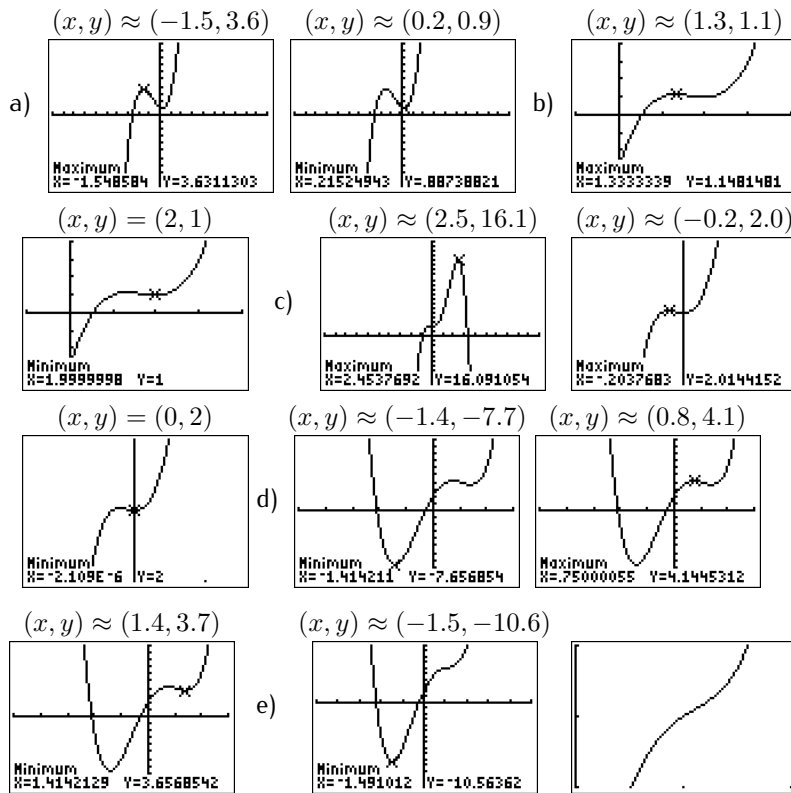

(there is only one minimum and no maximum in part (e))

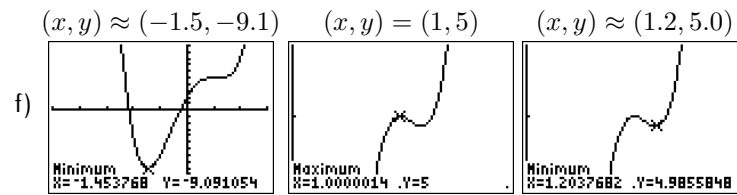

Session 5 (exercises starting on page 73):

Exercise 5.1 a) $y = |x| + 1$, b) $y = -\sqrt{x}$, c) $y = (x - 2)^2 + 1$, d) $y = \frac{1}{x+2} + 2$, e) $y = -(x + 2)^3$, f) $y = -|x - 3| + 2$

Exercise 5.2

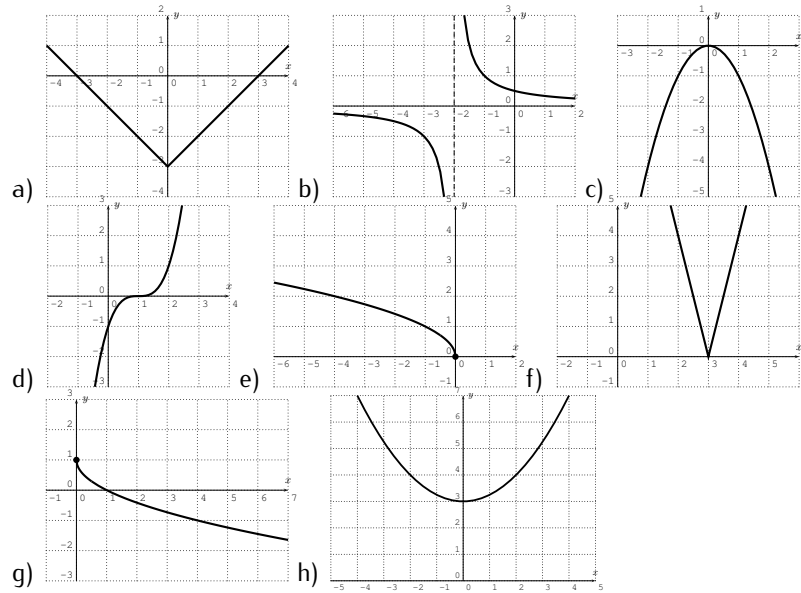

Exercise 5.3 a) $y = x^2 - 7x - 3$, b) $y = (x + 3)^2 - 7 \cdot (x + 3) + 1 = x^2 - x - 11$, c) $y = -x^2 + 7x - 1$, d) $y = x^2 + 7x + 1$, e) $y = \frac{1}{9}x^2 - \frac{7}{3}x + 1$, f) $y = 4x^2 - 14x + 1$

Exercise 5.4 a) shift to the right by 5, b) stretched away from the x -axis by a factor 2, c) shift to the right by 4, d) compressed towards the y -axis by a factor 2, e) shifted to the right by 3 (to get the graph of $y = \frac{1}{x}$) and then reflected about the x -axis, f) compressed towards the x -axis by a factor 2 (you get $y = |x|$) then shifted to the left by 1 and up by 1

Exercise 5.5 a) odd, b) even, c) even, d) neither, e) even, f) odd, g) even, h) neither, i) odd

Exercise 5.6

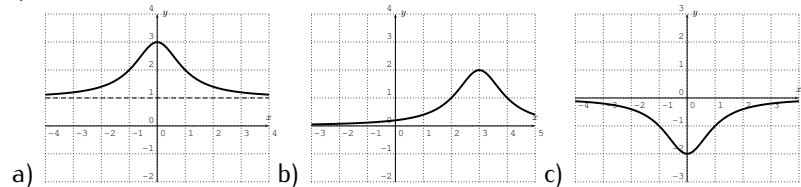

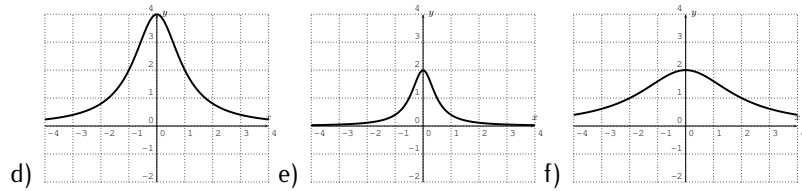

Session 6 (exercises starting on page 83):

- Exercise 6.1
- a) $(f + g)(x) = x^2 + 9x - 5$ with domain $D_{f+g} = \mathbb{R}$, $(f - g)(x) = x^2 + 3x + 5$ with domain $D_{f-g} = \mathbb{R}$, $(f \cdot g)(x) = 3x^3 + 13x^2 - 30x$ with domain $D_{f \cdot g} = \mathbb{R}$
- b) $(f + g)(x) = x^3 + 5x^2 + 12$, $D_{f+g} = \mathbb{R}$, $(f - g)(x) = x^3 - 5x^2 - 2$, $D_{f-g} = \mathbb{R}$, $(f \cdot g)(x) = 5x^5 + 7x^3 + 25x^2 + 35$, $D_{f \cdot g} = \mathbb{R}$
- c) $(f + g)(x) = 2x^2 + 3x + 12\sqrt{x}$, $D_{f+g} = [0, \infty)$, $(f - g)(x) = -2x^2 + 3x + 2\sqrt{x}$, $D_{f-g} = [0, \infty)$, $(f \cdot g)(x) = 6x^3 + 14x^2\sqrt{x} + 15x\sqrt{x} + 35x$, $D_{f \cdot g} = [0, \infty)$
- d) $(f + g)(x) = \frac{5x+1}{x+2}$, $D_{f+g} = \mathbb{R} - \{-2\}$, $(f - g)(x) = \frac{1-5x}{x+2}$, $D_{f-g} = \mathbb{R} - \{-2\}$, $(f \cdot g)(x) = \frac{5x}{(x+2)^2}$, $D_{f \cdot g} = \mathbb{R} - \{-2\}$
- e) $(f + g)(x) = 3\sqrt{x-3}$, $D_{f+g} = [3, \infty)$, $(f - g)(x) = -\sqrt{x-3}$, $D_{f-g} = [3, \infty)$, $(f \cdot g)(x) = 2 \cdot (\sqrt{x-3})^2 = 2 \cdot (x-3)$, $D_{f \cdot g} = [3, \infty)$
- f) $(f + g)(x) = x^2 + 5x - 1$, $D_{f+g} = \mathbb{R}$, $(f - g)(x) = x^2 - x + 11$, $D_{f-g} = \mathbb{R}$, $(f \cdot g)(x) = 3x^3 + 3x - 30$, $D_{f \cdot g} = \mathbb{R}$
- g) $(f + g)(x) = 3x^2 + 6x + 4$, $D_{f+g} = \mathbb{R}$, $(f - g)(x) = -x^2 - 4$, $D_{f-g} = \mathbb{R}$, $(f \cdot g)(x) = 2x^4 + 9x^3 + 13x^2 + 12x$, $D_{f \cdot g} = \mathbb{R}$
- Exercise 6.2
- a) $(\frac{f}{g})(x) = \frac{3x+6}{2x-8}$ with domain $D_{\frac{f}{g}} = \mathbb{R} - \{4\}$, $(\frac{g}{f})(x) = \frac{2x-8}{3x+6}$ with domain $D_{\frac{g}{f}} = \mathbb{R} - \{-2\}$, b) $(\frac{f}{g})(x) = \frac{x+2}{x^2-5x+4} = \frac{x+2}{(x-4)(x-1)}$, $D_{\frac{f}{g}} = \mathbb{R} - \{1, 4\}$, $(\frac{g}{f})(x) = \frac{x^2-5x+4}{x+2}$, $D_{\frac{g}{f}} = \mathbb{R} - \{-2\}$, c) $(\frac{f}{g})(x) = \frac{x+3}{(x-5)(x-2)}$, $D_{\frac{f}{g}} = \mathbb{R} - \{-3, 2, 5\}$, $(\frac{g}{f})(x) = \frac{(x-5)(x-2)}{x+3}$, $D_{\frac{g}{f}} = \mathbb{R} - \{-3, 5\}$, d) $(\frac{f}{g})(x) = \frac{\sqrt{x+6}}{2x+5}$, $D_{\frac{f}{g}} = [-6, -\frac{5}{2}) \cup (-\frac{5}{2}, \infty)$, $(\frac{g}{f})(x) = \frac{2x+5}{\sqrt{x+6}}$, $D_{\frac{g}{f}} = (-6, \infty)$, e) $(\frac{f}{g})(x) = \frac{x^2+8x-33}{\sqrt{x}}$, $D_{\frac{f}{g}} = (0, \infty)$, $(\frac{g}{f})(x) = \frac{\sqrt{x}}{x^2+8x-33}$, $D_{\frac{g}{f}} = [0, 3) \cup (3, \infty)$
- Exercise 6.3
- a) 37, b) 7, c) 11, d) 147, e) -1, f) 81, g) $12x^2 + 20x + 7$, h) $-4x - 9$, i) -141, j) -5, k) $2x + 2h - 3$, l) $3x^2 + 6xh + 3h^2 + 4x + 4h$
- Exercise 6.4
- a) $(f \circ g)(x) = 6x + 4$, b) $(f \circ g)(x) = x^2 + 6x + 11$, c) $(f \circ g)(x) = 4x^2 - 2x$, d) $(f \circ g)(x) = x^4 + 4x^3 + 4x^2 + \sqrt{x^2 + 2x + 3}$, e) $(f \circ g)(x) = \frac{2}{x+h+4}$, f) $(f \circ g)(x) = x^2 + 2xh + h^2 + 4x + 4h + 3$
- Exercise 6.5
- a) $(f \circ g)(x) = 2x - 6$, $(g \circ f)(x) = 2x - 1$, $(f \circ f)(x) = 4x + 12$, $(g \circ g)(x) = x - 10$
- b) $(f \circ g)(x) = x^2 - 2x + 3$, $(g \circ f)(x) = x^2 + 4x + 3$, $(f \circ f)(x) = x + 6$, $(g \circ g)(x) = x^4 - 4x^3 + 2x^2 + 4x$

c) $(f \circ g)(x) = 6x - 2 - \sqrt{3x+2}$, $(g \circ f)(x) = \sqrt{6x^2 - 3x - 16}$,
 $(f \circ f)(x) = 8x^4 - 8x^3 - 48x^2 + 25x + 72$, $(g \circ g)(x) = \sqrt{3\sqrt{3x+2} + 2}$
d) $(f \circ g)(x) = x$, $(g \circ f)(x) = x$, $(f \circ f)(x) = \frac{x+3}{3x+10}$, $(g \circ g)(x) = \frac{10x-3}{1-3x}$
e) $(f \circ g)(x) = x$, $(g \circ f)(x) = x$, $(f \circ f)(x) = (2(2x-7)^2 - 7)^2$ or
expanded in descending degrees: $(f \circ f)(x) = 64x^4 - 896x^3 + 4592x^2 -$
 $10192x + 8281$, $(g \circ g)(x) = \frac{\sqrt{\frac{x+7}{2}} + 7}{2} = \frac{14 + \sqrt{14 + 2\sqrt{x}}}{4}$

Exercise 6.6

x	1	2	3	4	5	6	7
$f(x)$	4	5	7	0	-2	6	4
$g(x)$	6	-8	5	2	9	11	2
$f(x) + 3$	7	8	10	3	1	9	7
$4g(x) + 5$	29	-28	25	13	41	49	13
$g(x) - 2f(x)$	-2	-18	-9	2	13	-1	-6
$f(x+3)$	0	-2	6	4	undef.	undef.	undef.

Note, however, that the complete table for $y = f(x+3)$ is given by:

x	-2	-1	0	1	2	3	4
$f(x+3)$	4	5	7	0	-2	6	4

Exercise 6.7

x	1	2	3	4	5	6
$f(x)$	3	1	2	5	6	3
$g(x)$	5	2	6	1	2	4
$(g \circ f)(x)$	6	5	2	2	4	6
$(f \circ g)(x)$	6	1	3	3	1	5
$(f \circ f)(x)$	2	3	1	6	3	2
$(g \circ g)(x)$	2	2	4	5	2	1

Exercise 6.8

x	0	2	4	6	8	10	12
$f(x)$	4	8	5	6	12	-1	10
$g(x)$	10	2	0	-6	7	2	8
$(g \circ f)(x)$	0	7	undef.	-6	8	undef.	2
$(f \circ g)(x)$	-1	8	4	undef.	undef.	8	12
$(f \circ f)(x)$	5	12	undef.	6	10	undef.	-1
$(g \circ g)(x)$	2	2	10	undef.	undef.	2	7

Session 7 (exercises starting on page 95):

Exercise 7.1 a) no (that is: the function is not one-to-one), b) yes, c) no, d) no, e)
no, f) no, g) yes, h) no

Exercise 7.2

- a) $f^{-1}(x) = \frac{x-9}{4}$, b) $f^{-1}(x) = -\frac{x+3}{8}$, c) $f^{-1}(x) = x^2 - 8$, d) $f^{-1}(x) = \frac{x^2-7}{3}$, e) $f^{-1}(x) = -\left(\frac{x}{6}\right)^2 - 2 = \frac{-x^2-72}{36}$, f) $f^{-1}(x) = \sqrt[3]{x}$, g) $f^{-1}(x) = \frac{\sqrt[3]{x-5}}{2}$, h) $f^{-1}(x) = \sqrt[3]{\frac{x-5}{2}}$, i) $f^{-1}(x) = \frac{1}{x}$, j) $f^{-1}(x) = \frac{1}{x} + 1 = \frac{1+x}{x}$, k) $f^{-1}(x) = \left(\frac{1}{x}\right)^2 + 2 = \frac{1+2x^2}{x^2}$, l) $f^{-1}(x) = \frac{5}{y} + 4 = \frac{5+4y}{y}$, m) $f^{-1}(x) = \frac{2x}{1-x}$, n) $f^{-1}(x) = \frac{6x}{x-3}$, o) $f^{-1}(x) = \frac{2-3x}{x-1}$, p) $f^{-1}(x) = \frac{5x+7}{x+1}$

q)

x	3	7	1	8	5	2
$f^{-1}(x)$	2	4	6	8	10	12

Exercise 7.3

- a) restricting to the domain $D = [0, \infty)$ gives the inverse $f^{-1}(x) = \sqrt{x}$, b) restricting to the domain $D = [-5, \infty)$ gives the inverse $f^{-1}(x) = \sqrt{x-1} - 5$, c) restricting to the domain $D = [0, \infty)$ gives the inverse $f^{-1}(x) = x$, d) restricting to the domain $D = [4, \infty)$ gives the inverse $f^{-1}(x) = x + 6$, e) restricting to the domain $D = (0, \infty)$ gives the inverse $f^{-1}(x) = \sqrt{\frac{1}{x}}$, f) restricting to the domain $D = (-7, \infty)$ gives the inverse $f^{-1}(x) = \sqrt{-\frac{3}{x}} - 7$, g) restricting to the domain $D = [0, \infty)$ gives the inverse $f^{-1}(x) = \sqrt[4]{x}$, h) restricting to the domain $D = [3, \infty)$ gives the inverse $f^{-1}(x) = 3 + \sqrt[4]{10x}$

Exercise 7.4

- a) yes (that is: the functions f and g are inverses of each other), b) no, c) no, d) yes, e) no, f) yes

Exercise 7.5

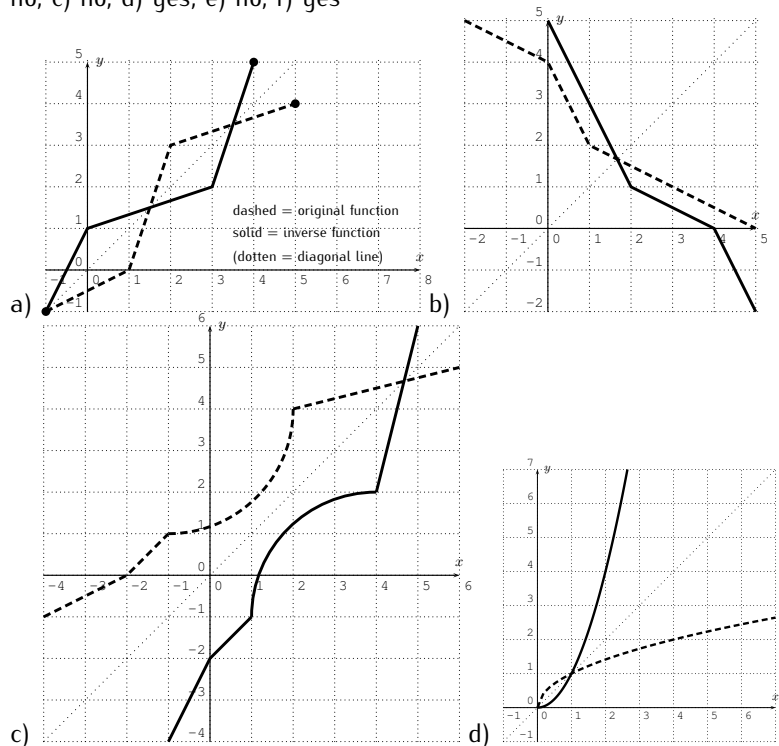

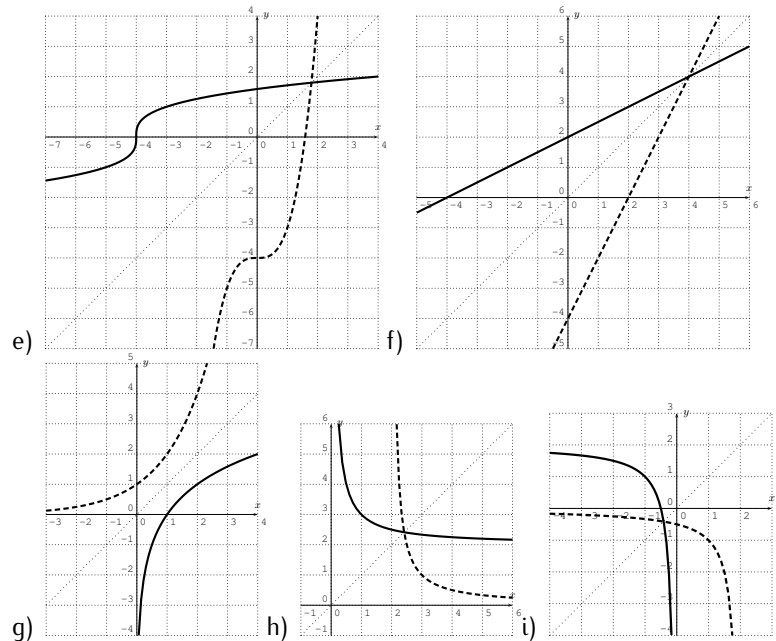

Review of part I (exercises starting on page 98):

Exercises I

1. $x = 1$ or $x = 5$, 2. $y = -\frac{1}{2}x + 1$, 3. $x \approx 2.52$, 4. $2x - 2 + 2h$, 5. domain $D = [2, 7]$, range $R = (1, 4]$, $f(3) = 2$, $f(5) = 2$, $f(7) = 4$, $f(9)$ is undefined, 6. $f(x) = -x^2 + 2$, 7. $(\frac{f}{g})(x) = \frac{5x+4}{x^2+8x+7} = \frac{5x+4}{(x+7)(x+1)}$ has domain $D = \mathbb{R} - \{-7, -1\}$, 8. $(f \circ g)(x) = 4x^2 - 12x + 9 + \sqrt{2x - 6}$ has domain $D = [3, \infty)$, 9. f and g are both functions, and the composition is given by the table:

x	2	3	4	5	6
$f(x)$	5	0	2	4	2
$g(x)$	6	2	3	4	1
$(f \circ g)(x)$	2	5	0	2	undef.

10. $f^{-1}(x) = \frac{1}{2x} - \frac{5}{2}$

Session 8 (exercises starting on page 111):

Exercise 8.1

- a) $x^2 - 2x - 2 - \frac{3}{x-2}$, b) $x^2 + 3x - 2 + \frac{4}{x+3}$, c) $x + 6 - \frac{10}{x+1}$, d) $x^2 + x + \frac{5}{x+2}$, e) $2x^2 + 3x + 6 + \frac{11}{x-1}$, f) $2x^3 - 3x^2 + 15x - 74 + \frac{373}{x+5}$, g) $2x^3 + 8x^2 + x + 4 + \frac{3}{x-4}$, h) $x^2 - 3x + 9$, i) $x^3 + 2x^2 + x + 2 + \frac{2}{3x+1}$, j) $4x^2 + 3x + 6$, k) $x + 1 - \frac{7x+6}{x^2+2x+1}$, l) $x^3 + 3x^2 - 3x - 9 + \frac{9x+7}{x^2+3}$

Exercise 8.2

- a) remainder $r = 15$, b) $r = 20$, c) $r = -2$, d) $r = 12$

Exercise 8.3

- a) yes, $g(x)$ is a factor of $f(x)$, the root of $f(x)$ is $x = -3$, b) $g(x)$ is not a factor of $f(x)$, c) $g(x)$ is a factor of $f(x)$, the root of $f(x)$ is $x = -7$, d) $g(x)$ is a factor of $f(x)$, the root of $f(x)$ is $x = -1$

Exercise 8.4

- a) $f(x) = (x-2)(x-1)(x+1)$, b) $f(x) = (x-1)(x-2)(x-3)$, c) $f(x) = (x-3)(x-i)(x+i)$, d) $f(x) = (x+2)^3$, e) $f(x) = (x+2)(x+4)(x+7)$, f) $f(x) = (x-4)(x+3)(x+4)$, g) $f(x) = (x-2)(x-1)(x+1)(x+2)(x+5)$

Exercise 8.5 a) $2x^2 + 7x + 9 + \frac{25}{x-2}$, b) $4x^2 - 9x + 12 - \frac{18}{x+3}$, c) $x^2 + 2x - 7 + \frac{15}{x+2}$, d) $x^3 + 2x^2 + 2x + 2 + \frac{3}{x-1}$, e) $x^4 - 2x^3 + 4x^2 - 8x + 16$, f) $x^2 - 3 + \frac{5}{x+5}$.

Session 9 (exercises starting on page 127):

Exercise 9.1 a) yes, b) no (due to the discontinuity), c) no (due to horizontal asymptote), d) no (due to corner), e) yes (polynomial of degree 1), f) yes

Exercise 9.2 a) corresponds to (iii), b) corresponds to (v), c) corresponds to (vi), d) corresponds to (ii), e) corresponds to (iv)

Exercise 9.3 a) corresponds to (iii), b) corresponds to (i), c) corresponds to (ii)

Exercise 9.4 The windows and graphs are displayed below for all parts (a)-(f).

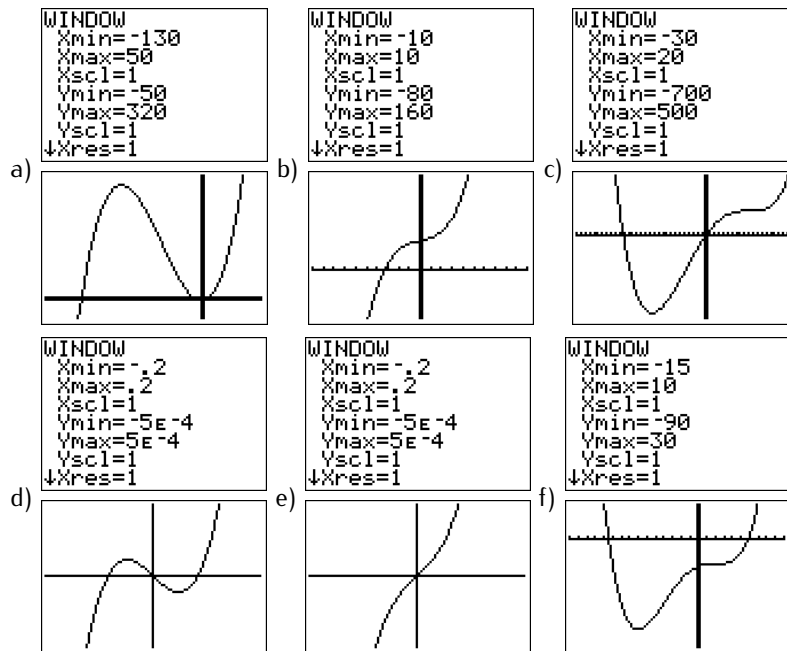

Exercise 9.5 a) $x = 2, x = 3,$ or $x = 5$, b) $x = -1$, c) $x = 11$, d) $x = -8, x = -3, x = -2,$ or $x = 4$, e) $x = -3 \pm \sqrt{6}$ (use the quadratic formula), f) $x = 0$

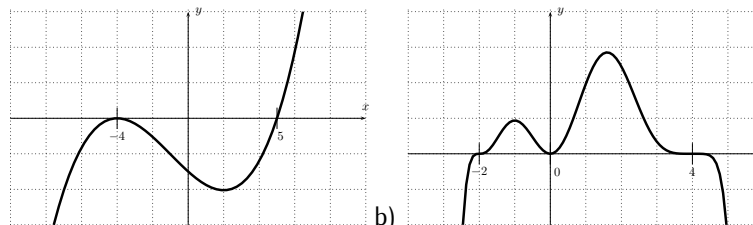

Exercise 9.6

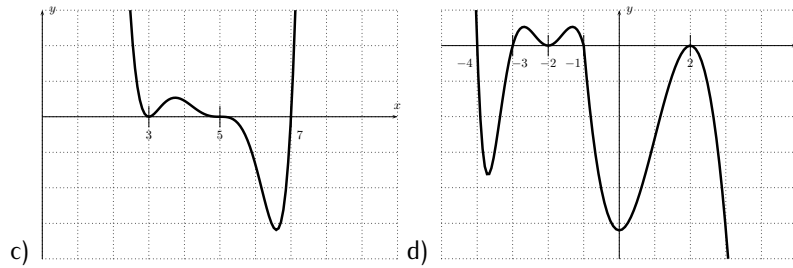

Session 10 (exercises starting on page 144):

Exercise 10.1 a) $x = -1, x = 2, x = \frac{1}{2}$, b) $x = \frac{1}{3}$, c) $x = \frac{-3}{2}, x = -1, x = \frac{4}{3}$, d) $x = \frac{1}{2}, x = \frac{-2}{3}, x = -2 + \sqrt{3}, x = -2 - \sqrt{3}$, e) $x = -\frac{1}{4}$

Exercise 10.2 a) $x = 1$, b) $x = 1$ or $x = -1$, c) $x = 3$, d) $x = -10$, e) $x = 3$ or $x = -3$, f) $x = 5$, g) $x = -2$, h) $x = 1$, i) $x = 8i$ or $x = -8i$

Exercise 10.3 a) $f(x) = (x-2)(x-1)(x+3)$, b) $f(x) = (x-5)(x+2)^2$, c) $f(x) = (x-1)(x+1)(x-2)(x+2)$, d) $f(x) = (x-2)(x - \frac{-3+\sqrt{5}}{2})(x - \frac{-3-\sqrt{5}}{2})$, e) $f(x) = 2(x + \frac{3}{2})(x+1)(x-2)$, f) $f(x) = 12(x - \frac{2}{3})(x + \frac{3}{4})(x+4)$, g) $f(x) = (x-1)(x+1)(x-i)(x+i)$, h) $f(x) = x(x-1)(x+1)(x-3)^2$, i) $f(x) = (x-3)(x - \frac{-3+3\sqrt{3}\cdot i}{2})(x - \frac{-3-3\sqrt{3}\cdot i}{2})$, j) $f(x) = (x - \sqrt{3})(x + \sqrt{3})(x - \sqrt{5}\cdot i)(x + \sqrt{5}\cdot i)$

Exercise 10.4

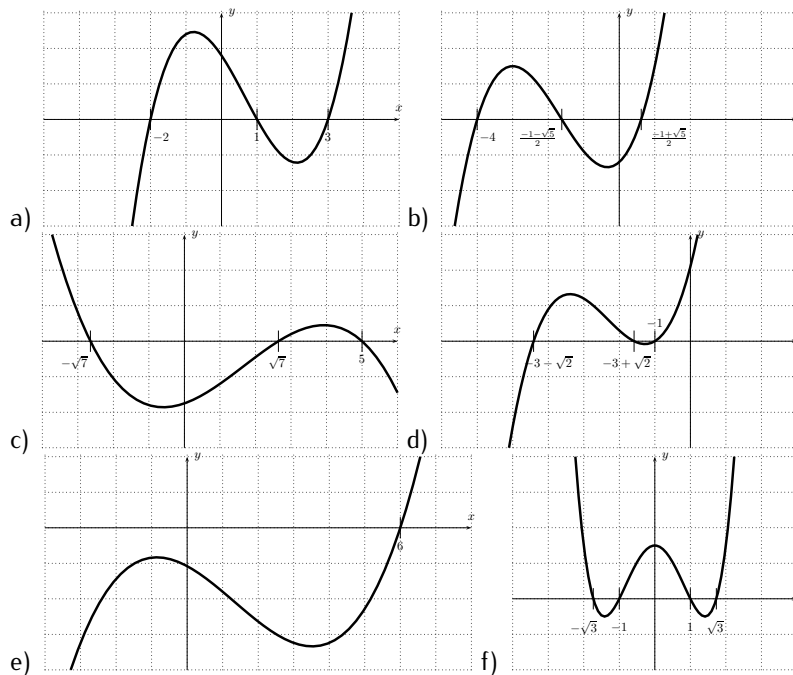

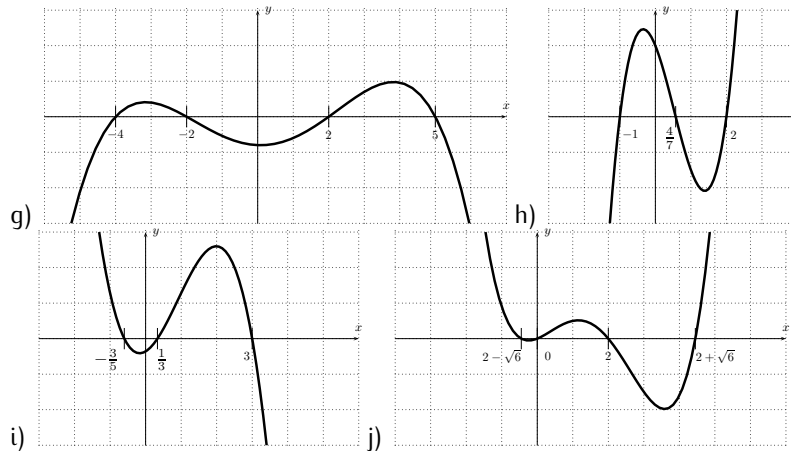

Exercise 10.5

- a) $f(x) = 2(x-2)(x-3)(x-4)$, b) $f(x) = (-1) \cdot x(x-2)(x+1)(x+3)$, c) $f(x) = (-\frac{5}{2}) \cdot (x-2)(x+2)(x+1)$, d) $f(x) = -2 \cdot x(x-2)(x+1)(x+4)$, e) $f(x) = 3(x-7)(x-(2+5i))(x-(2-5i))$, f) $f(x) = (-2) \cdot (x-i)(x+i)(x-3)$, g) $f(x) = \frac{7}{4} \cdot (x-(5+i))(x-(5-i))(x-3)^2$, h) $f(x) = (x-i)(x+i)(x-(3+2i))(x-(3-2i))$ (other correct answers are possible, depending on the choice of the first coefficient), i) $f(x) = (x-(1+i))(x-(2+i))(x-(4-3i))(x+2)^3$ (other correct answers are possible, depending on the choice of the first coefficient), j) $f(x) = (x-i)(x-3)(x+7)^2$ (other correct answers are possible, depending on the choice of the first coefficient and the fourth root), k) $f(x) = (x-2)(x-3)(x-4)$ (other correct answers are possible, depending on the choice of the first coefficient), l) $f(x) = (x-1)^2(x-3)^2$, m) $f(x) = -x(x-1)(x-3)(x-4)$ (other correct answers are possible, depending on the choice of the first coefficient)

Session 11 (exercises starting on page 168):

- Exercise 11.1 a) domain $D = \mathbb{R} - \{2\}$, vertical asymptote at $x = 2$, no removable discontinuities, b) $D = \mathbb{R} - \{2, 4\}$, vertical asympt. at $x = 2$ and $x = 4$, no removable discontin., c) $D = \mathbb{R} - \{-2, 0, 2\}$, vertical asympt. at $x = 0$ and $x = 2$, removable discontin. at $x = -2$, d) $D = \mathbb{R} - \{-3, 2, 5\}$, vertical asympt. at $x = 2$ and $x = 5$, removable discontin. at $x = -3$, e) $D = \mathbb{R} - \{1\}$, no vertical asympt., removable discontin. at $x = 1$, f) $D = \mathbb{R} - \{-1, 1, 2\}$, vertical asympt. at $x = -1$ and $x = 1$ and $x = 2$, no removable discontin.
- Exercise 11.2 a) $y = 4$, b) $y = 0$, c) no horizontal asymptote (asymptotic behavior $y = x + 4$), d) $y = -4$
- Exercise 11.3 a) x -intercept at $x = 3$, y -intercept at $y = 3$, b) x -intercepts at $x = 0$ and $x = -2$ and $x = 2$, y -intercept at $y = 0$, c) x -intercepts at $x = -4$ and $x = 1$ and $x = 3$, y -intercept at $y = \frac{6}{5}$, d) x -intercept at $x = -3$ (but not at $x = -2$ since $f(-2)$ is undefined), no y -intercept since $f(0)$ is undefined

Exercise 11.4

a) $D = \mathbb{R} - \{-2\}$, horizontal asympt. $y = 3$, vertical asympt. $x = -2$, no removable disc., x -intercept at $x = \frac{1}{3}$, y -intercept at $y = \frac{-1}{2}$, graph:

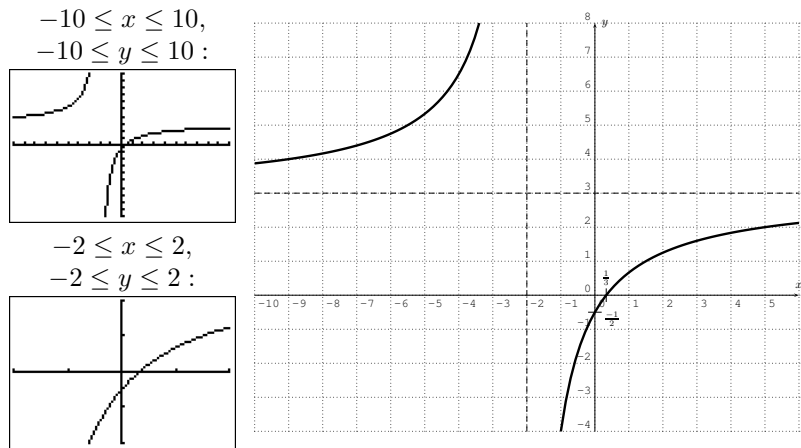

b) $f(x) = \frac{x-3}{(x-4)(x-1)(x+2)}$ has domain $D = \mathbb{R} - \{-2, 1, 4\}$, horizontal asympt. $y = 0$, vertical asympt. $x = -2$ and $x = 1$ and $x = 4$, no removable disc., x -intercept at $x = 3$, y -intercept at $y = \frac{-3}{8} = -0.375$, graph:

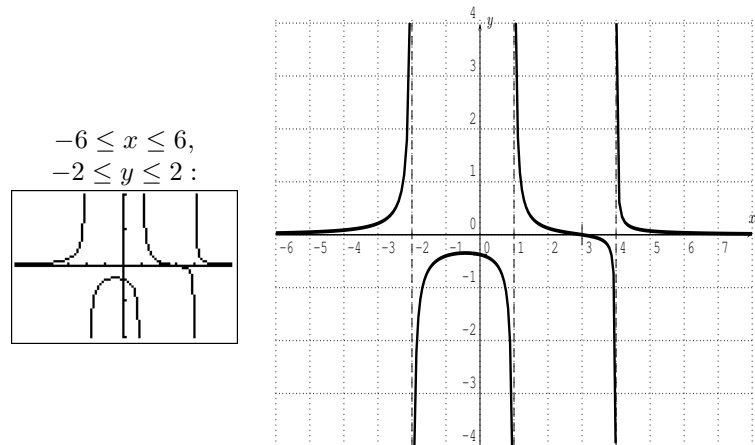

c) $f(x) = \frac{(x-3)(x+3)(x-1)(x+1)}{(x-2)(x-1)}$ has domain $D = \mathbb{R} - \{1, 2\}$, no horizontal asympt., vertical asympt. $x = 2$, removable disc. at $x = 1$, x -intercept at $x = -3$ and $x = -1$ and $x = 3$, y -intercept at $y = \frac{9}{2} = 4.5$, graph:

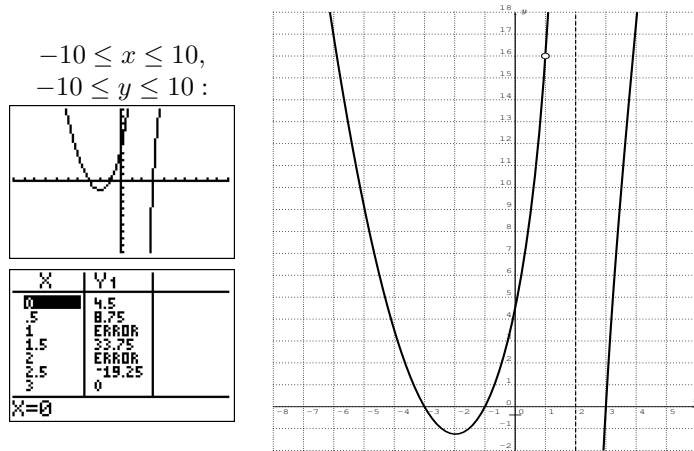

d) $f(x) = \frac{(x-3)(x-1)(x+1)}{x^2(x-2)}$ has domain $D = \mathbb{R} - \{0, 2\}$, horizontal asympt. $y = 1$, vertical asympt. $x = 0$ and $x = 2$, no removable discontin., x -intercepts at $x = -1$ and $x = 1$ and $x = 3$, no y -intercept since $f(0)$ is undefined, graph:

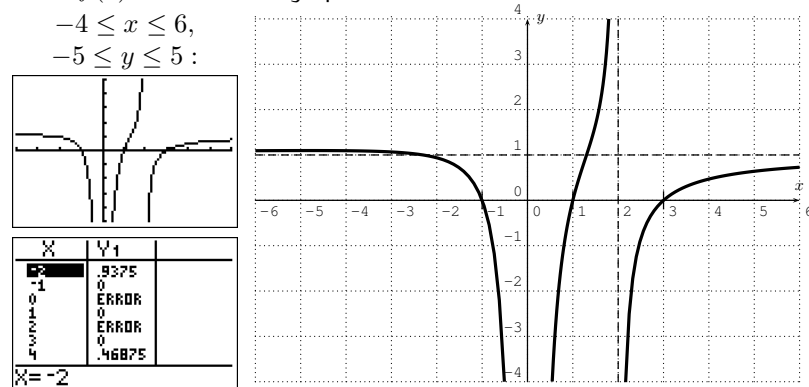

Note that the graph intersects the horizontal asymptote $y = 1$ at approximately $x \approx -2.3$ and approaches the asymptote from above.

Exercise 11.5 a) for example $f(x) = \frac{1}{x-4}$, b) for example $f(x) = \frac{5x^2}{x^2-5x+6}$, c) for example $f(x) = \frac{x^2-x}{x-1}$

Session 12 (exercises starting on page 179):

Exercise 12.1 a) $x \leq 3$, b) $\frac{1}{2} > x$, c) $-4 \geq x$, d) $x > \frac{22}{5}$, e) $-5 \leq x \leq 7$, f) $-4 < x \leq 3$, g) $x \geq 2$ (this then also implies $x \geq -\frac{7}{2}$), h) no solution

Exercise 12.2 a) $(-\infty, -2) \cup (7, \infty)$, b) $(-\infty, -5] \cup [7, \infty)$, c) $[-2, 2]$, d) $(\frac{-3-\sqrt{21}}{2}, \frac{-3+\sqrt{21}}{2})$, e) $[-3, 2]$, f) $(-\frac{1}{3}, 1)$, g) $\mathbb{R} - \{2\}$, h) $[-2, 1] \cup [3, \infty)$, i) $(-\infty, -4)$, j) $(0, 2) \cup (2, \infty)$, k) $[-3, -1] \cup [1, 3]$, l) $(-1, 1) \cup (2, 3)$, m) $(-\infty, 0) \cup (0, 2) \cup (3, \infty)$, n) $(-\infty, -2] \cup [0, 1] \cup [2, 5]$, o) $[1, 2] \cup [3, 4] \cup [5, \infty)$, p) $(-\infty, 1]$

Exercise 12.3 a) $D = (-\infty, 3] \cup [5, \infty)$, b) $D = (-\infty, -3] \cup [0, 3]$, c) $D = [1, 4]$, d) $D = [2, 5] \cup [6, \infty)$, e) $D = (-\infty, 3)$, f) $D = (-\infty, -1) \cup (7, \infty)$

Exercise 12.4 a) $(2, 5)$, b) $(-2, 1] \cup (2, \infty)$, c) $(-\infty, -1) \cup (2, 5)$, d) $(-\infty, -3] \cup (-2, 2) \cup [3, \infty)$, e) $(-\infty, -5] \cup (-3, \infty)$, f) $(-10, -9.8)$, g) $(-1, 2) \cup [4, \infty)$, h) $(-\infty, -4) \cup [0, \infty)$

Exercise 12.5 a) $(-\infty, -8) \cup (1, \infty)$, b) $(\frac{-5}{6}, \frac{1}{6})$, c) $(-\infty, \frac{1}{3}) \cup [3, \infty)$, d) $[-12, -2]$, e) $(-\infty, -\frac{1}{4}) \cup [\frac{1}{2}, \infty)$, f) $(-15, -5)$

Review of part II (exercises starting on page 181):

Exercises II 1. $x^2 - x - 3 + \frac{1}{2x+3}$, 2. 21, 3. $x - 1$ is a factor, $x + 1$ is not a factor, $x - 0$ is not a factor, 4. a) \leftrightarrow iii), b) \leftrightarrow iv), c) \leftrightarrow i), d) \leftrightarrow ii),

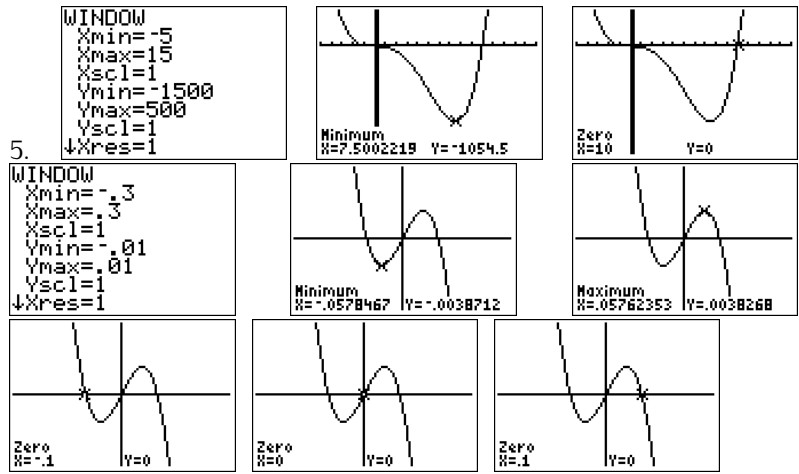

6. $f(x) = (x - 1)(x + 3)(x + 4)$, 7. $f(x) = (-5) \cdot x(x - 1)(x - 3)$, 8. $f(x) = (x + 2)(x - 5)(x - (3 - 2i))(x - (3 + 2i))$ (other correct answers are possible, depending on the choice of the first coefficient),

9. $f(x) = \frac{3(x-2)(x+2)}{(x-3)(x+1)}$ has domain $D = \mathbb{R} - \{-1, 3\}$, horizontal asympt. $y = 3$, vertical asympt. $x = -1$ and $x = 3$, no removable discont., x -intercepts at $x = -2$ and $x = 2$ and $x = 3$, y -intercept at $y = 4$, graph:

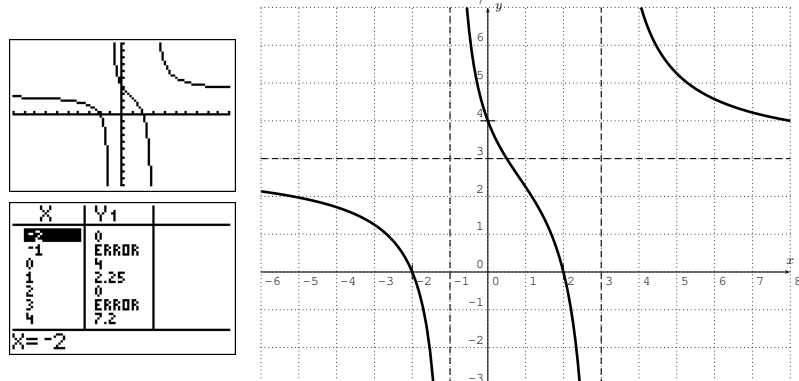

10. a) $(-1, 0) \cup (1, 2)$, b) $(-\infty, \frac{-3-\sqrt{37}}{2}] \cup [\frac{-3+\sqrt{37}}{2}, \infty)$, c) $(-\infty, -7] \cup (-4, \infty)$

Session 13 (exercises starting on page 197):

Exercise 13.1

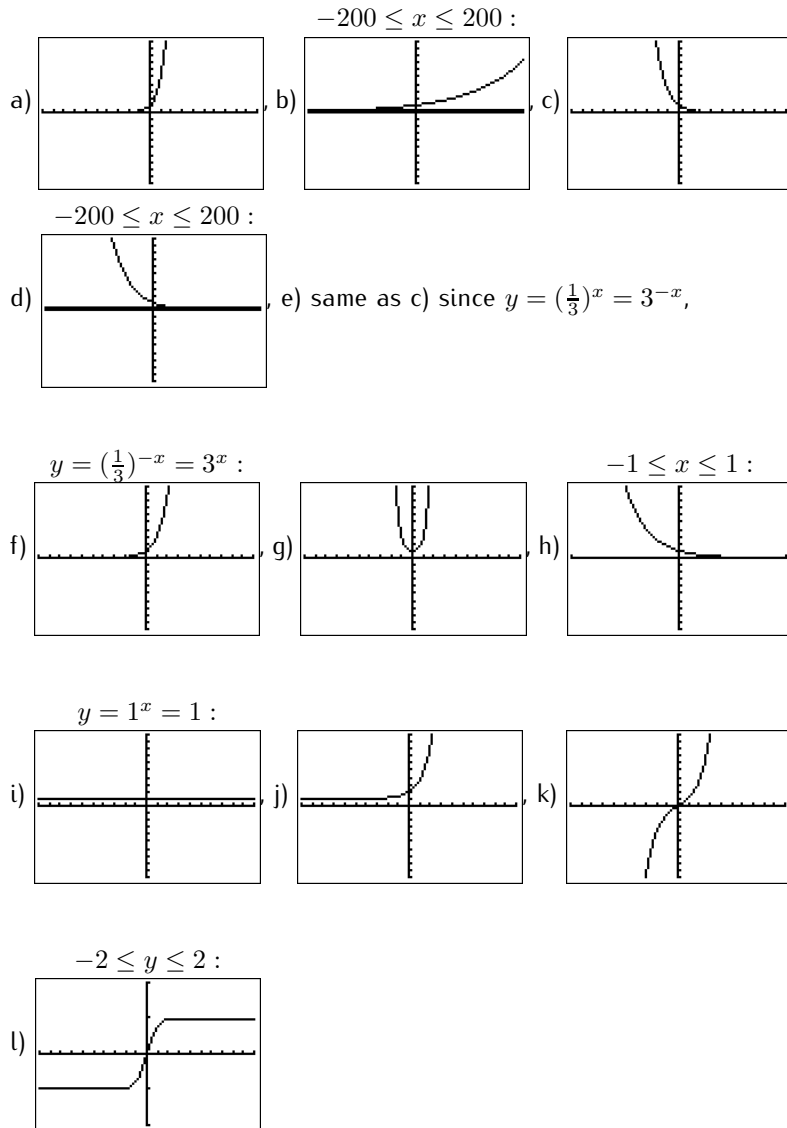

Exercise 13.2

a) $y = 4^x$ is compressed towards the x -axis by the factor 0.1 (graph below), b) $y = 2^x$ stretched away from x -axis, c) $y = 2^x$ reflected about the x -axis, d) $y = 2^x$ compressed towards the x -axis, e) $y = e^x$ reflected about the y -axis, f) $y = e^x$ reflected about the y -axis and shifted up by 1, g) $y = (\frac{1}{2})^x$ shifted up by 3, h) $y = 2^x$ shifted to the right by 4, i) $y = 2^x$ shifted to the left by 1 and down by 6

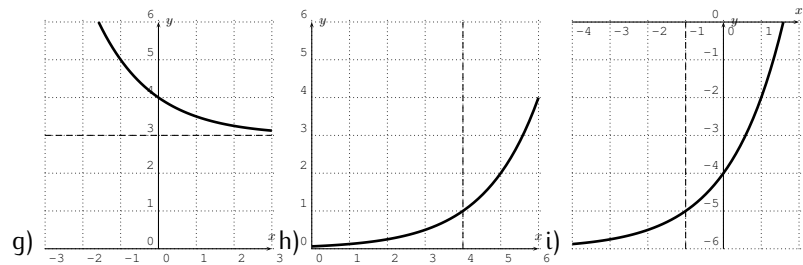
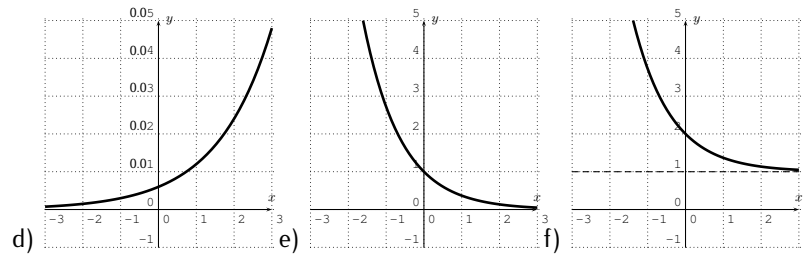
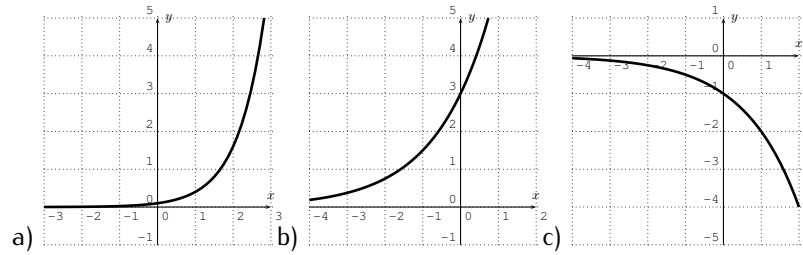

Exercise 13.3 a) $\log_4(16) = 2$, b) $\log_2(256) = 8$, c) $\ln(7) = x$, d) $\log(0.1) = -1$, e) $\log_3(12) = x$, f) $\log_5(12) = 7x$, g) $\log_3(44) = 2a + 1$, h) $\log_{\frac{1}{2}}(30) = \frac{x}{h}$

Exercise 13.4 a) 2, b) 4, c) 6, d) 2, e) -2, f) 3, g) 4, h) 1, i) -1, j) -2, k) 0, l) -3

Exercise 13.5 a) 3.561, b) 2.262, c) -0.290, d) -4.911

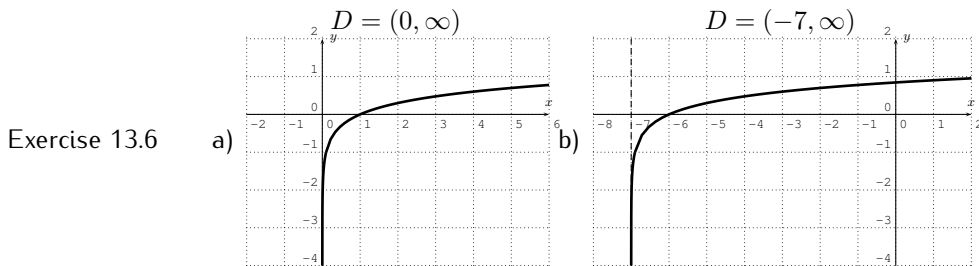

Exercise 13.6

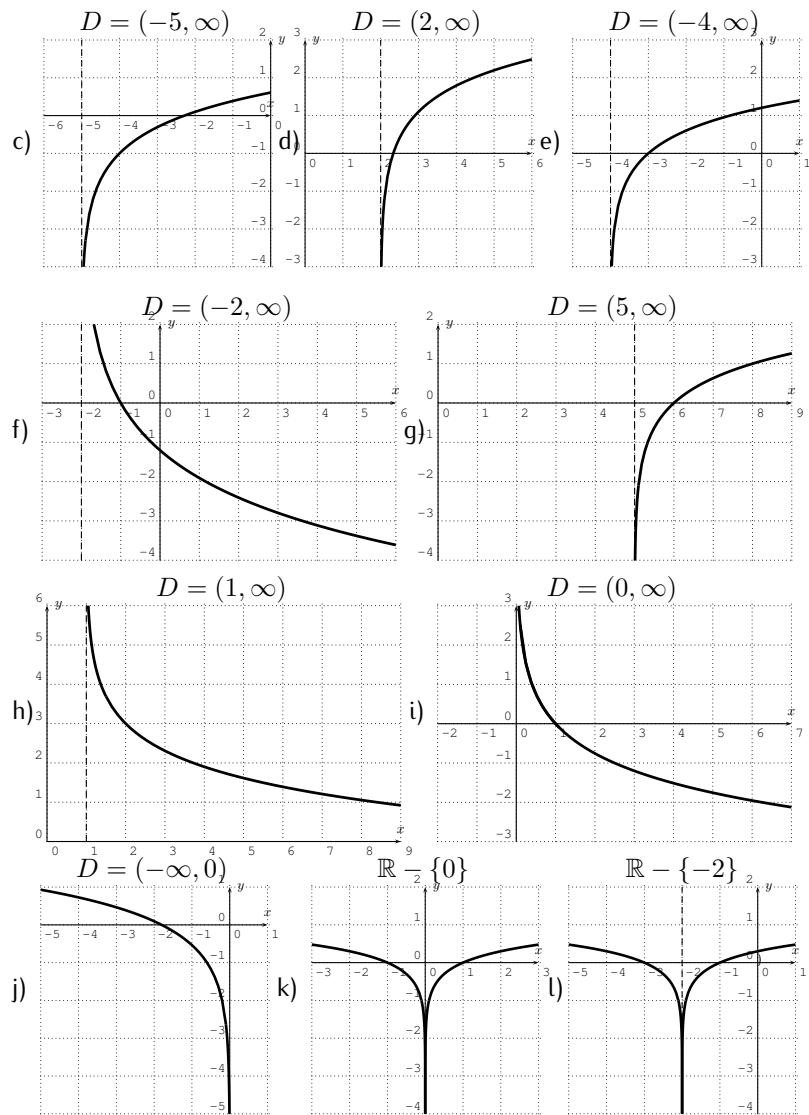

Session 14 (exercises starting on page 206):

- Exercise 14.1 a) $\ln(x^3 \cdot y)$, b) $\log\left(\frac{x}{y^3}\right) = \log\left(\frac{x}{y^3}\right)$, c) $\log\left(\frac{\sqrt[3]{xz^4}}{y}\right)$, d) $\log\left(\frac{z}{x^3y}\right)$,
 e) $\ln\left(\frac{\sqrt[4]{x}\sqrt[3]{z^2}}{\sqrt{y}}\right)$, f) $\ln\left(\frac{1}{x+1}\right)$, g) $\ln(x^{10})$, h) $\log_5(25 \cdot (a+1))$
- Exercise 14.2 a) $3u + v$, b) $\frac{2}{3}u + \frac{7}{4}v$, c) $\frac{1}{2}u + \frac{1}{6}v$, d) $3u - 4v$, e) $2u - \frac{1}{2}v - 2w$, f) $\frac{1}{2}u + \frac{3}{2}v - \frac{1}{4}w$, g) $\frac{3}{4}u - 3v + \frac{1}{4}w$, h) $2 - 2v + \frac{1}{5}w$, i) $\frac{1}{6}v + \frac{4}{3}w - \frac{2}{3}$
- Exercise 14.3 a) $x = 4$, b) $x = 4$, c) $x = 9$, d) $x = -2$, e) $x = -\frac{6}{5}$, f) $x = 2$, g) $x = -2$, h) $x = \frac{11}{2}$, i) $x = \frac{10}{17}$, j) $x = \frac{7}{6}$
- Exercise 14.4 a) $x = 3$, b) $x = 6$, c) $x = \frac{5}{31}$, d) $x = 76$, e) $x = 1$, f) $x = 8$, g) $x = 18$, h) $x = 25$, i) $x = 2$, j) $x = -1$

- Exercise 14.5 a) $x = \frac{\log 57}{\log 4} \approx 2.92$, b) $x = \frac{\log 7}{\log 9} + 2 \approx 2.89$, c) $x = \frac{\log 31}{\log 2} - 1 \approx 3.94$,
 d) $x = \frac{\log(63) - 7 \log(3.8)}{2 \log(3.8)} \approx -1.95$, e) $x = \frac{5 \cdot \log(5)}{\log(8) - \log(5)} \approx 17.12$, f)
 $x = \frac{2 \cdot \log(3)}{\log(0.4) - \log(3)} \approx -1.09$, g) $x = \frac{9 \log(1.02)}{2 \log(1.02) - \log(4.35)} \approx -0.12$, h)
 $x = \frac{\log(4) - 2 \log(5)}{\log(5) - \log(4)} \approx -8.21$, i) $x = \frac{3 \log(9) + 6 \log(4)}{\log(9) + \log(4)} \approx 4.16$, j) $x =$
 $\frac{7 \log(2.4) - 4 \log(3.8)}{2 \log(2.4) + 3 \log(3.8)} \approx 0.14$, k) $x = \frac{4 \log(9) - 2 \log(4)}{2 \log(9) - 9 \log(4)} \approx -0.74$, l) $x =$
 $\frac{4 \log(1.2) + 4 \log(1.95)}{7 \log(1.2) - 3 \log(1.95)} \approx -4.68$

Session 15 (exercises starting on page 214):

- Exercise 15.1 a) $f(x) = 4 \cdot 3^x$, b) $f(x) = 5 \cdot 2^x$, c) $f(x) = 3200 \cdot 0.1^x$, d) $f(x) = 1.5 \cdot 2^x$,
 e) $f(x) = 20 \cdot 5^x$, f) $f(x) = \frac{3}{5} \cdot \sqrt{5}^x$
- Exercise 15.2 a) $y = 8.4 \cdot 1.101^t$ with $t = 0$ corresponding to the year 2005, b) approx.
 22.0 million, c) It will reach 20 million in the year 2014.
- Exercise 15.3 a) $y = 79000 \cdot 1.037^t$ with $t = 0$ corresponding to the year 1990, b)
 approx. 163,400, c) approx. 195,900, d) The city will reach maximum
 capacity in the year 2061.
- Exercise 15.4 The city will be at 90% of its current size after approximately 4.5 years.
- Exercise 15.5 It will take the company 4.87 years.
- Exercise 15.6 The ant colony has doubled its population after approximately 23.4
 weeks.
- Exercise 15.7 It will take 4.27 months for the beehive to have decreased to half its
 current size.
- Exercise 15.8 It will take 139.0 years until the world population has doubled.

Session 16 (exercises starting on page 226):

- Exercise 16.1 It takes 49.262 minutes until 2 mg are left of the element.
- Exercise 16.2 2.29 grams are left after 1 year.
- Exercise 16.3 The half-life of fermium-252 is 25.38 minutes.
- Exercise 16.4 You have to wait approximately 101.3 days.
- Exercise 16.5 67.8% of the carbon-14 is left in the year 2000.
- Exercise 16.6 The wood is approximately 3323 years old.
- Exercise 16.7 The bone is approximately 3952 years old.
- Exercise 16.8 a) \$7,346.64, b) It takes approximately 18 years.
- Exercise 16.9 a) \$862.90, b) \$1,564.75, c) \$1,566.70, d) \$541.46, e) \$6,242.86, f)
 \$1,654.22, g) \$910.24
- Exercise 16.10 a) $P = \$1,484.39$, b) $P = \$2,938.67$, c) $P = \$709.64$, d) $r = 4.23\%$,
 e) $r = 4.31\%$, f) $t \approx 1.69$ years, g) $t \approx 3.81$ years, h) $t \approx 10.27$ years,
 i) $t \approx 13.73$ years

Review of part III (exercises starting on page 229):

- Exercises III 1. 37.5 million, 2. 19.1 hours, 3. a) $\ln(\sqrt[3]{x^2 y^4})$, b) $\log_2\left(\frac{\sqrt{x z^3}}{4 \sqrt[4]{y^3}}\right)$, 4. a)
 $\frac{4}{3}u - 2v$, b) $u + \frac{5}{2}v$, c) $\frac{1}{5}u + \frac{4}{5}v$, 5. $x = 9$, 6. a) $x = \frac{2 \log 6}{\log 7 - \log 6}$, b)
 $x \approx 23.25$, 7. 1.82 hours, 8. 3561 years, 9. \$1,828.48, 10. $r = 6.5\%$

Session 17 (exercises starting on page 249):

- Exercise 17.1 a) $\sin(120^\circ) = \frac{\sqrt{3}}{2}$, $\cos(120^\circ) = -\frac{1}{2}$, $\tan(120^\circ) = -\sqrt{3}$, b) $\sin(390^\circ) = \frac{1}{2}$, $\cos(390^\circ) = \frac{\sqrt{3}}{2}$, $\tan(390^\circ) = \frac{\sqrt{3}}{3}$, c) $\sin(-150^\circ) = -\frac{1}{2}$, $\cos(-150^\circ) = -\frac{\sqrt{3}}{2}$, $\tan(-150^\circ) = \frac{\sqrt{3}}{3}$, d) $\sin(-45^\circ) = -\frac{\sqrt{2}}{2}$, $\cos(-45^\circ) = \frac{\sqrt{2}}{2}$, $\tan(-45^\circ) = -1$, e) $\sin(1050^\circ) = -\frac{1}{2}$, $\cos(1050^\circ) = \frac{\sqrt{3}}{2}$, $\tan(1050^\circ) = -\frac{\sqrt{3}}{3}$, f) $\sin(-810^\circ) = -1$, $\cos(-810^\circ) = 0$, $\tan(-810^\circ)$ is undefined, g) $\sin(\frac{5\pi}{4}) = -\frac{\sqrt{2}}{2}$, $\cos(\frac{5\pi}{4}) = -\frac{\sqrt{2}}{2}$, $\tan(\frac{5\pi}{4}) = 1$, h) $\sin(\frac{5\pi}{6}) = \frac{1}{2}$, $\cos(\frac{5\pi}{6}) = -\frac{\sqrt{3}}{2}$, $\tan(\frac{5\pi}{6}) = -\frac{\sqrt{3}}{3}$, i) $\sin(\frac{10\pi}{3}) = -\frac{\sqrt{3}}{2}$, $\cos(\frac{10\pi}{3}) = -\frac{1}{2}$, $\tan(\frac{10\pi}{3}) = \sqrt{3}$, j) $\sin(\frac{15\pi}{2}) = -1$, $\cos(\frac{15\pi}{2}) = 0$, $\tan(\frac{15\pi}{2})$ is undefined, k) $\sin(-\frac{\pi}{6}) = -\frac{1}{2}$, $\cos(-\frac{\pi}{6}) = \frac{\sqrt{3}}{2}$, $\tan(-\frac{\pi}{6}) = -\frac{\sqrt{3}}{3}$, l) $\sin(-\frac{54\pi}{8}) = -\frac{\sqrt{2}}{2}$, $\cos(-\frac{54\pi}{8}) = -\frac{\sqrt{2}}{2}$, $\tan(-\frac{54\pi}{8}) = 1$

- Exercise 17.2 a) shift $y = \sin(x)$ up by 2 (see graph below), b) $y = \cos(x)$ shifted to the right by π , c) $y = \tan(x)$ shifted down by 4, d) $y = \sin(x)$ stretched away from the x -axis by a factor 5, e) $y = \cos(x)$ compressed towards the y -axis by a factor 2, f) $y = \sin(x)$ shifted to the right by 2 and down by 5

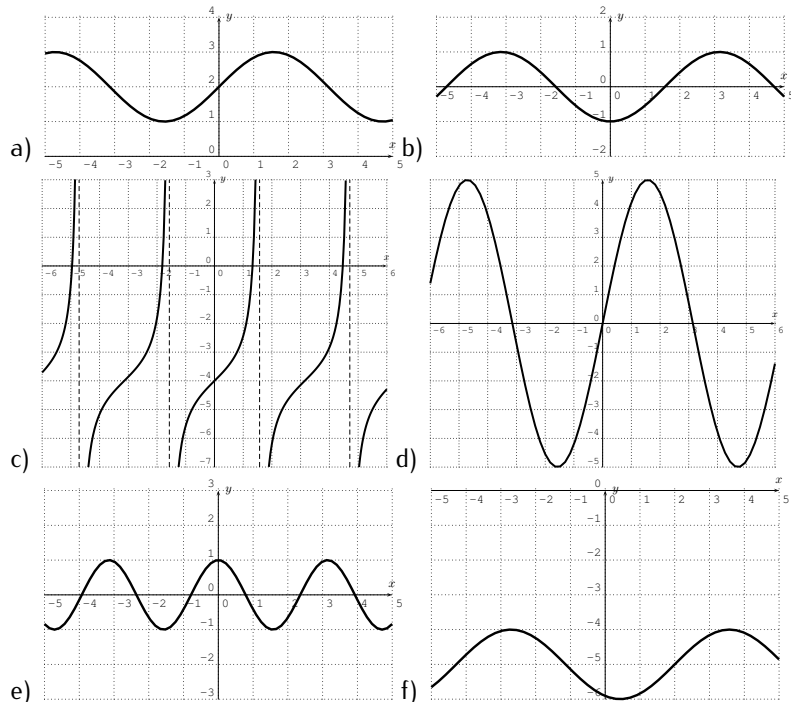

- Exercise 17.3 a) $g(x)$, b) $h(x)$, c) $j(x)$, d) $k(x)$, e) $i(x)$, f) $f(x)$

- Exercise 17.4 a) $y = 5 \cos(x)$, b) $y = -5 \cos(x)$, c) $y = -5 \sin(x)$, d) $y = \cos(x) + 5$, e) $y = \sin(x) + 5$, f) $y = 2 \sin(x) + 3$

Exercise 17.5

- a) amplitude 5, period π , phase-shift $\frac{-3}{2}$, b) amplitude 1, period 2, phase-shift $\frac{5}{\pi}$, c) amplitude 6, period $\frac{\pi}{2}$, phase-shift 0, d) amplitude 2, period 2π , phase-shift $\frac{-\pi}{4}$, e) amplitude 8, period π , phase-shift 3, f) amplitude 3, period 8π , phase-shift 0, g) amplitude 1, period 2π , phase-shift -2 , h) amplitude 7, period 5, phase-shift 3, i) amplitude 1, period π , phase-shift 0

Exercise 17.6

- a) amplitude 5, period π , phase-shift 0 (graph see below), b) amplitude 4, period 2, phase-shift 0, c) amplitude 2, period 3, phase-shift 0, d) amplitude 1, period π , phase-shift $\frac{\pi}{2}$, e) amplitude 1, period 2, phase-shift 1, f) amplitude 6, period 8π , phase-shift 0, g) amplitude 1, period $\frac{\pi}{2}$, phase-shift $\frac{-\pi}{4}$, h) amplitude 7, period 2π , phase-shift $\frac{-\pi}{4}$, i) amplitude 5, period 2π , phase-shift $\frac{-3\pi}{2}$, j) amplitude 4, period $\frac{2\pi}{5}$, phase-shift $\frac{\pi}{5}$, k) amplitude 3, period 1, phase-shift $\frac{2}{5}$, l) amplitude 7, period 8π , phase-shift $-\pi$, m) amplitude 1, period $\frac{2\pi}{3}$, phase-shift $\frac{4\pi}{3}$, n) amplitude 2, period 10π , phase-shift $\frac{\pi}{2}$, o) amplitude $\frac{1}{3}$, period $\frac{5\pi}{7}$, phase-shift $\frac{3\pi}{7}$

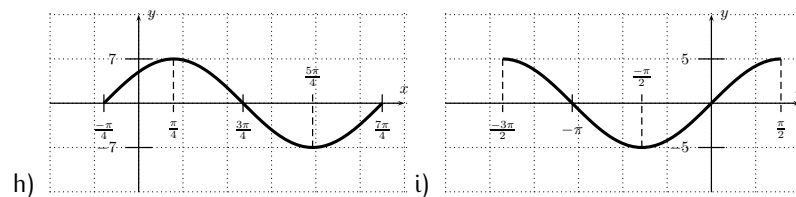
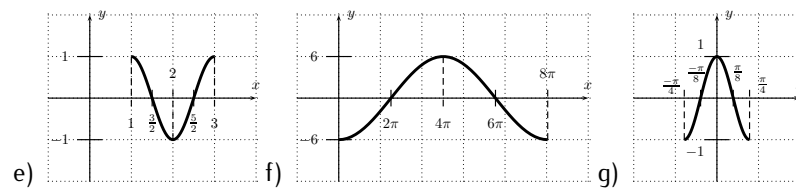
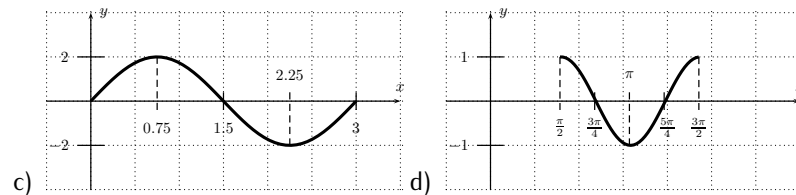
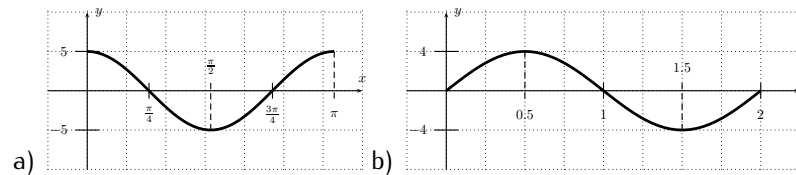

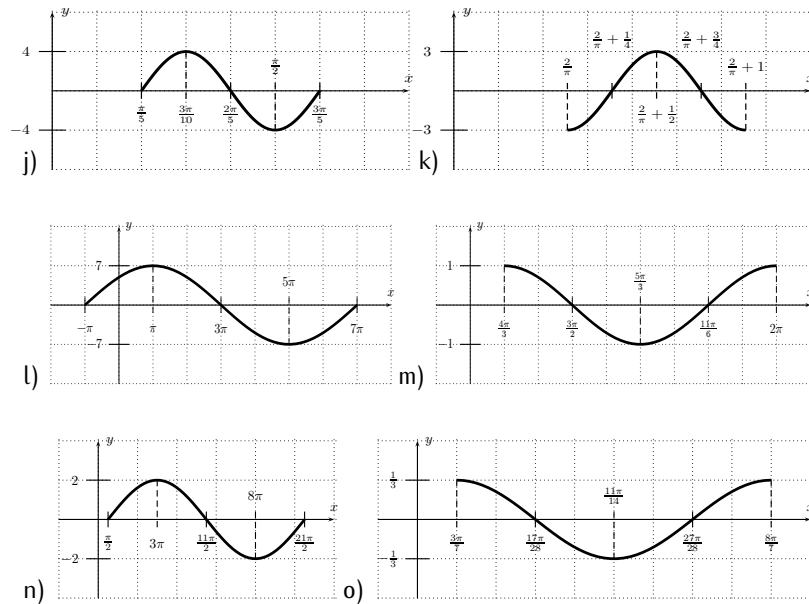

Session 18 (exercises starting on page 261):

Exercise 18.1 a) $\frac{\sqrt{2}+\sqrt{6}}{4}$, b) $\frac{\sqrt{6}-\sqrt{2}}{4}$, c) $2 - \sqrt{3}$, d) $\frac{\sqrt{2}+\sqrt{6}}{4}$, e) $\frac{-(\sqrt{2}+\sqrt{6})}{4}$, f) $\frac{\sqrt{3}}{2}$, g) $\frac{1}{2}$,
h) $\frac{-\sqrt{2}}{2}$, i) $2 - \sqrt{3}$, j) $\frac{\sqrt{2}+\sqrt{6}}{4}$, k) $\frac{\sqrt{6}-\sqrt{2}}{4}$, l) $\frac{\sqrt{2}+\sqrt{6}}{4}$

Exercise 18.2 a) $\sin(x + \frac{\pi}{2}) = \cos(x)$, b) $\cos(x - \frac{\pi}{4}) = \frac{\sqrt{2}}{2}(\sin(x) + \cos(x))$,
c) $\tan(\pi - x) = -\tan(x)$, d) $\sin(\frac{\pi}{6} - x) = \frac{1}{2}\cos(x) - \frac{\sqrt{3}}{2}\sin(x)$,
e) $\cos(x + \frac{11\pi}{12}) = (\frac{-(\sqrt{2}+\sqrt{6})}{4}) \cdot \cos(x) - (\frac{\sqrt{6}-\sqrt{2}}{4}) \cdot \sin(x)$, f)
 $\cos(\frac{2\pi}{3} - x) = \frac{-1}{2} \cdot \cos(x) + \frac{\sqrt{3}}{2} \cdot \sin(x)$

Exercise 18.3 a) $\frac{\sqrt{2+\sqrt{3}}}{2} = \frac{\sqrt{2}+\sqrt{6}}{4}$, b) $\sqrt{2} - 1$, c) $\frac{\sqrt{8-2\sqrt{2}-2\sqrt{6}}}{4}$, d) $\frac{\sqrt{8+2\sqrt{2}+2\sqrt{6}}}{4}$, e)
 $-\frac{\sqrt{2-\sqrt{2}}}{2}$, f) $1 + \sqrt{2}$, g) $-\frac{\sqrt{2-\sqrt{2}}}{2}$, h) $\frac{\sqrt{2+\sqrt{2}+\sqrt{3}}}{2}$

Exercise 18.4 a) $\sin(\frac{\alpha}{2}) = \frac{\sqrt{5}}{5}$, $\cos(\frac{\alpha}{2}) = \frac{2\sqrt{5}}{5}$, $\tan(\frac{\alpha}{2}) = \frac{1}{2}$, $\sin(2\alpha) = \frac{24}{25}$,
 $\cos(2\alpha) = \frac{-7}{25}$, $\tan(2\alpha) = \frac{-24}{7}$, b) $\sin(\frac{\alpha}{2}) = \frac{\sqrt{39}}{13}$, $\cos(\frac{\alpha}{2}) = \frac{-\sqrt{130}}{13}$,
 $\tan(\frac{\alpha}{2}) = \frac{-\sqrt{30}}{10}$, $\sin(2\alpha) = \frac{-28\sqrt{30}}{169}$, $\cos(2\alpha) = \frac{-71}{169}$, $\tan(2\alpha) = \frac{28\sqrt{30}}{71}$,
c) $\sin(\frac{\alpha}{2}) = \frac{3\sqrt{10}}{10}$, $\cos(\frac{\alpha}{2}) = \frac{-\sqrt{10}}{10}$, $\tan(\frac{\alpha}{2}) = -3$, $\sin(2\alpha) = \frac{24}{25}$,
 $\cos(2\alpha) = \frac{7}{25}$, $\tan(2\alpha) = \frac{24}{7}$, d) $\sin(\frac{\alpha}{2}) = \frac{2\sqrt{5}}{5}$, $\cos(\frac{\alpha}{2}) = \frac{-\sqrt{5}}{5}$,
 $\tan(\frac{\alpha}{2}) = -2$, $\sin(2\alpha) = \frac{24}{25}$, $\cos(2\alpha) = \frac{-7}{25}$, $\tan(2\alpha) = \frac{-24}{7}$, e)
 $\sin(\frac{\alpha}{2}) = \frac{5\sqrt{26}}{26}$, $\cos(\frac{\alpha}{2}) = \frac{\sqrt{26}}{26}$, $\tan(\frac{\alpha}{2}) = 5$, $\sin(2\alpha) = \frac{-120}{169}$,
 $\cos(2\alpha) = \frac{119}{169}$, $\tan(2\alpha) = \frac{-120}{119}$, f) $\sin(\frac{\alpha}{2}) = \frac{\sqrt{30}}{6}$, $\cos(\frac{\alpha}{2}) = \frac{\sqrt{6}}{6}$,
 $\tan(\frac{\alpha}{2}) = \sqrt{5}$, $\sin(2\alpha) = \frac{-4\sqrt{5}}{9}$, $\cos(2\alpha) = \frac{-1}{9}$, $\tan(2\alpha) = 4\sqrt{5}$

Session 19 (exercises starting on page 269):

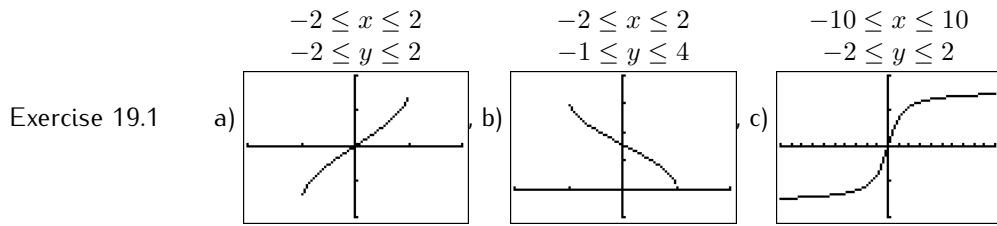

Exercise 19.2 a) $\frac{\pi}{3}$, b) $\frac{\pi}{6}$, c) $\frac{\pi}{3}$, d) 0, e) $\frac{\pi}{4}$, f) $\frac{3\pi}{4}$, g) $-\frac{\pi}{2}$, h) $-\frac{\pi}{3}$, i) $\frac{5\pi}{6}$, j) $-\frac{\pi}{4}$, k) $-\frac{\pi}{3}$, l) $-\frac{\pi}{6}$

Exercise 19.3 a) 1.37, b) -0.85 , c) 1.23, d) 1.57, e) -1.11 , f) undefined, g) 47.16° , h) -45° , i) 75° , j) 90.00° , k) 67.5° , l) -7.5°

Session 20 (exercises starting on page 283):

Exercise 20.1 a) $x = \frac{\pi}{6} + n\pi$, where $n = 0, \pm 1, \dots$, b) $x = (-1)^n \frac{\pi}{3} + n\pi$, where $n = 0, \pm 1, \dots$, c) $x = (-1)^{n+1} \frac{\pi}{4} + n\pi$, where $n = 0, \pm 1, \dots$, d) $x = \pm \frac{\pi}{6} + 2n\pi$, where $n = 0, \pm 1, \dots$, e) $x = \pm \frac{\pi}{2} + 2n\pi$, where $n = 0, \pm 1, \dots$, f) $x = \pm \frac{2\pi}{3} + 2n\pi$, where $n = 0, \pm 1, \dots$, g) $x = 2n\pi$, where $n = 0, \pm 1, \dots$, h) there is no solution (since $-1 \leq \sin(x) \leq 1$), i) $x = n\pi$, where $n = 0, \pm 1, \dots$, j) $x = (-1)^{n+1} \frac{\pi}{2} + n\pi$, where $n = 0, \pm 1, \dots$, (since each solution appears twice, it is enough to take $n = 0, \pm 2, \pm 4, \dots$), k) $x = \frac{-\pi}{3} + n\pi$, where $n = 0, \pm 1, \dots$, l) $x = \pm \cos^{-1}(0.2) + 2n\pi$, where $n = 0, \pm 1, \dots$

Exercise 20.2 a) $x \approx 1.411 + n\pi$, where $n = 0, \pm 1, \dots$, b) $x \approx \pm 1.104 + 2n\pi$, where $n = 0, \pm 1, \dots$, c) $x \approx (-1)^n 1.143 + n\pi$, where $n = 0, \pm 1, \dots$, d) $x \approx \pm 2.453 + 2n\pi$, where $n = 0, \pm 1, \dots$, e) $x \approx -0.197 + n\pi$, where $n = 0, \pm 1, \dots$, f) $x \approx (-1)^{n+1} 0.06 + n\pi$, where $n = 0, \pm 1, \dots$

Exercise 20.3 a) $\frac{-\pi}{4}, \frac{3\pi}{4}, \frac{7\pi}{4}, \frac{-5\pi}{4}, \frac{-9\pi}{4}$, b) $\frac{\pi}{4}, \frac{-\pi}{4}, \frac{9\pi}{4}, \frac{-9\pi}{4}, \frac{17\pi}{4}, \frac{-17\pi}{4}$, c) $\frac{-\pi}{3}, \frac{4\pi}{3}, \frac{5\pi}{3}, \frac{-2\pi}{3}, \frac{-7\pi}{3}$, d) $0, \pi, 2\pi, -\pi, -2\pi$, e) $\frac{\pi}{2}, \frac{-\pi}{2}, \frac{3\pi}{2}, \frac{-3\pi}{2}, \frac{5\pi}{2}, \frac{-5\pi}{2}$, f) $\cos^{-1}(0.3), -\cos^{-1}(0.3), \cos^{-1}(0.3) + 2\pi, -\cos^{-1}(0.3) + 2\pi, \cos^{-1}(0.3) - 2\pi, -\cos^{-1}(0.3) - 2\pi$, g) $\sin^{-1}(0.4), -\sin^{-1}(0.4) + \pi, -\sin^{-1}(0.4) - \pi, \sin^{-1}(0.4) + 2\pi, \sin^{-1}(0.4) - 2\pi$, h) $\frac{3\pi}{2}, \frac{7\pi}{2}, \frac{11\pi}{2}, \frac{-\pi}{2}, \frac{-5\pi}{2}$

Exercise 20.4 a) $x = \frac{\pi}{4} + n\pi$, where $n = 0, \pm 1, \dots$, b) $x = (-1)^n \frac{\pi}{6} + n\pi$, where $n = 0, \pm 1, \dots$, c) $x = \pm \frac{\pi}{6} + 2n\pi$, where $n = 0, \pm 1, \dots$, d) $x = \pm \frac{2\pi}{3} + 2n\pi$, where $n = 0, \pm 1, \dots$, e) $x = \frac{\pi}{6} + n\pi$, where $n = 0, \pm 1, \dots$, f) $x = \pm \frac{\pi}{3} + n\pi$, where $n = 0, \pm 1, \dots$, g) $x = \pm \frac{\pi}{2} + n\pi$, where $n = 0, \pm 1, \dots$, h) $x = \pi + 2n\pi$, where $n = 0, \pm 1, \dots$ (Note: The solution given by the formula from page 277 is $x = \pm\pi + 2n\pi$ with $n = 0, \pm 1, \dots$. Since every solution appears twice in this expression, we can reduce this to $x = \pi + 2n\pi$), i) $x = \pm \frac{\pi}{3} + 2n\pi$, where $n = 0, \pm 1, \dots$, j) $x = (-1)^{n+1} \frac{\pi}{6} + n\pi$, where $n = 0, \pm 1, \dots$, k) $x = (-1)^{n+1} \frac{\pi}{2} + n\pi$, or $x = (-1)^n \frac{\pi}{6} + n\pi$, where $n = 0, \pm 1, \dots$, l) $x = 2n\pi$, or $x = \pm \frac{\pi}{3} + 2n\pi$, where $n = 0, \pm 1, \dots$, m) $x = \pm \frac{\pi}{3} + n\pi$, where $n = 0, \pm 1, \dots$, n) $x = \pm \frac{\pi}{4} + n\pi$, or $x = n\pi$, where $n = 0, \pm 1, \dots$

- Exercise 20.5 a) $x \approx -1.995 + 2n\pi$, or $x \approx 0.424 + 2n\pi$, where $n = 0, \pm 1, \dots$, b) $x \approx -0.848 + n\pi$, or $x \approx 0.148 + n\pi$, or $x \approx 0.700 + n\pi$, where $n = 0, \pm 1, \dots$, c) $x \approx 0.262 + n\frac{2\pi}{3}$, or $x \approx 0.906 + n\frac{2\pi}{3}$, or $x \approx 1.309 + n\frac{2\pi}{3}$, or $x \approx 1.712 + n\frac{2\pi}{3}$, where $n = 0, \pm 1, \dots$, d) $x \approx 0.443 + 2n\pi$, or $x \approx 2.193 + 2n\pi$, where $n = 0, \pm 1, \dots$

Review of part IV (exercises starting on page 284):

Exercises IV 1.

x	$0 = 0^\circ$	$\frac{\pi}{6} = 30^\circ$	$\frac{\pi}{4} = 45^\circ$	$\frac{\pi}{3} = 60^\circ$	$\frac{\pi}{2} = 90^\circ$
$\sin(x)$	0	$\frac{1}{2}$	$\frac{\sqrt{2}}{2}$	$\frac{\sqrt{3}}{2}$	1
$\cos(x)$	1	$\frac{\sqrt{3}}{2}$	$\frac{\sqrt{2}}{2}$	$\frac{1}{2}$	0
$\tan(x)$	0	$\frac{\sqrt{3}}{3}$	1	$\sqrt{3}$	undef.

2. a) $\frac{\sqrt{3}}{2}$, b) $-\frac{\sqrt{2}}{2}$, c) $-\sqrt{3}$, 3. a) $-\frac{\sqrt{2}}{2}$, b) $\frac{\sqrt{3}}{2}$, 4. a) amplitude 3, period $\frac{\pi}{2}$, phase-shift $\frac{\pi}{4}$, b) amplitude 5, period 2π , phase-shift $-\frac{\pi}{2}$ (graphs below):

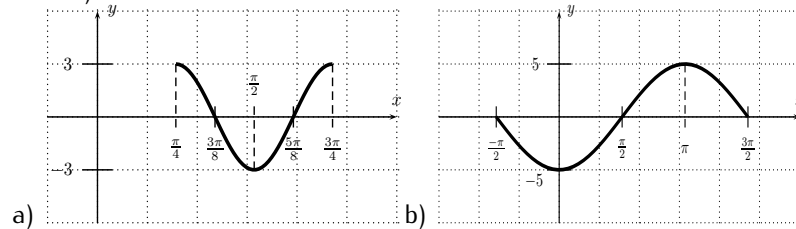

5. a) $\frac{\sqrt{2}+\sqrt{6}}{4}$, b) $\frac{\sqrt{2}-\sqrt{2}}{2}$, 6. $\sin(2\alpha) = \frac{24}{25}$, $\cos(2\alpha) = \frac{-7}{25}$, $\tan(2\alpha) = \frac{-24}{7}$, 7. a) $-\frac{\pi}{6}$, b) $\frac{5\pi}{6}$, c) $-\frac{\pi}{6}$, 8. $x = (-1)^{n+1}\frac{\pi}{3} + n\pi$, where $n = 0, \pm 1, \dots$, 9. $x = \pm\frac{\pi}{4} + n\pi$, where $n = 0, \pm 1, \dots$, 10. a) $x = \pm\frac{\pi}{4} + 2n\pi$, or $x = \pm\frac{3\pi}{4} + 2n\pi$, where $n = 0, \pm 1, \dots$, b) $(-1)^{n+1}\frac{\pi}{6} + n\pi$, where $n = 0, \pm 1, \dots$

Session 21 (exercises starting on page 297):

Exercise 21.1

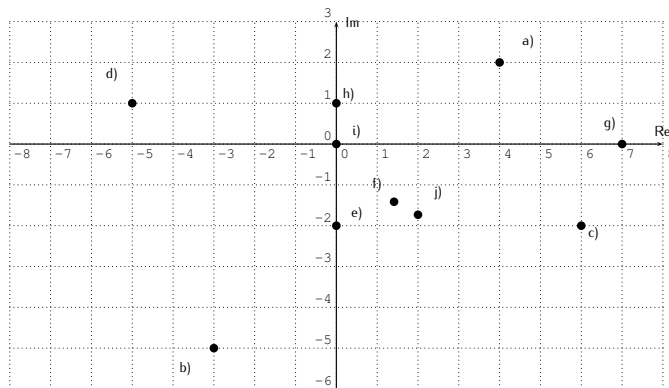

- Exercise 21.2 a) $3 + 4i$, b) $-14 + 2i$, c) $6 + 17i$, d) $6 - 7i$, e) $\frac{7}{5} + \frac{4}{5}i$, f) $-\frac{1}{2} + \frac{3}{2}i$
- Exercise 21.3 a) 5, b) $\sqrt{5}$, c) 3, d) $2\sqrt{10}$, e) 3, f) 4, g) 5, h) 7
- Exercise 21.4 a) $2\sqrt{2}(\cos(\frac{\pi}{4}) + i\sin(\frac{\pi}{4}))$, b) $8(\cos(\frac{\pi}{6}) + i\sin(\frac{\pi}{6}))$, c) approximately $\sqrt{13}(\cos(-.588) + i\sin(-.588))$ or $\sqrt{13}(\cos(-.187\pi) + i\sin(-.187\pi))$, d) $5\sqrt{2}(\cos(\frac{3\pi}{4}) + i\sin(\frac{3\pi}{4}))$, e) approximately $5(\cos(-.644) + i\sin(-.644))$ or $5(\cos(-.205\pi) + i\sin(-.205\pi))$, f) approximately $5(\cos(2.498) + i\sin(2.498))$ or $5(\cos(.795\pi) + i\sin(.795\pi))$, g) $2\sqrt{5}(\cos(\frac{4\pi}{3}) + i\sin(\frac{4\pi}{3}))$, h) $2\sqrt{7}(\cos(-\frac{\pi}{3}) + i\sin(-\frac{\pi}{3}))$ i) approximately $13(\cos(4.318) + i\sin(4.318))$ or $13(\cos(1.374\pi) + i\sin(1.374\pi))$ j) $6(\cos(\frac{\pi}{2}) + i\sin(\frac{\pi}{2}))$, k) $10(\cos(\pi) + i\sin(\pi))$, l) $2\sqrt{3}(\cos(\frac{2\pi}{3}) + i\sin(\frac{2\pi}{3}))$
- Exercise 21.5 a) approximately $-4.168 + 4.316i$, b) approximately $.491 + 0.0919i$, c) $-2i$, d) $\frac{\sqrt{3}}{2} + \frac{1}{2}i$, e) $-5\sqrt{3} - 5i$, f) approximately $1.553 - 5/796i$
- Exercise 21.6 a) $40(\cos(60^\circ) + i\sin(60^\circ)) = 20 + 20\sqrt{3}i$, b) $42(\cos(\frac{\pi}{3}) + i\sin(\frac{\pi}{3})) = 21 + 21\sqrt{3}i$, c) $\cos(\frac{\pi}{6}) + i\sin(\frac{\pi}{6}) = \frac{\sqrt{3}}{2} + \frac{1}{2}i$, d) $12(\cos(\pi) + i\sin(\pi)) = -12$, e) $.1(\cos(284^\circ) + i\sin(284^\circ)) \approx .0242 - .0970i$, f) $\cos(\frac{2\pi}{3}) + i\sin(\frac{2\pi}{3}) = -\frac{1}{2} + \frac{\sqrt{3}}{2}i$
- Exercise 21.7 a) $6(\cos(\pi/3) + i\sin(\pi/3)) = 3 + 3\sqrt{3}i$, b) $\frac{2}{3}(\cos(90^\circ) + i\sin(90^\circ)) = \frac{2}{3}i$, c) $2(\cos(\pi/2) + i\sin(\pi/2)) = 2i$, d) $\frac{1}{2}(\cos(\frac{3\pi}{2}) + i\sin(\frac{3\pi}{2})) = -\frac{1}{2}i$, e) $6(\cos(\frac{4\pi}{3}) + i\sin(\frac{4\pi}{3})) = -3 - 3\sqrt{3}i$, f) $\frac{5}{3}(\cos(-319^\circ) + i\sin(-319^\circ)) \approx 1.258 + 1.093i$

Session 22 (exercises starting on page 309):

Exercise 22.1

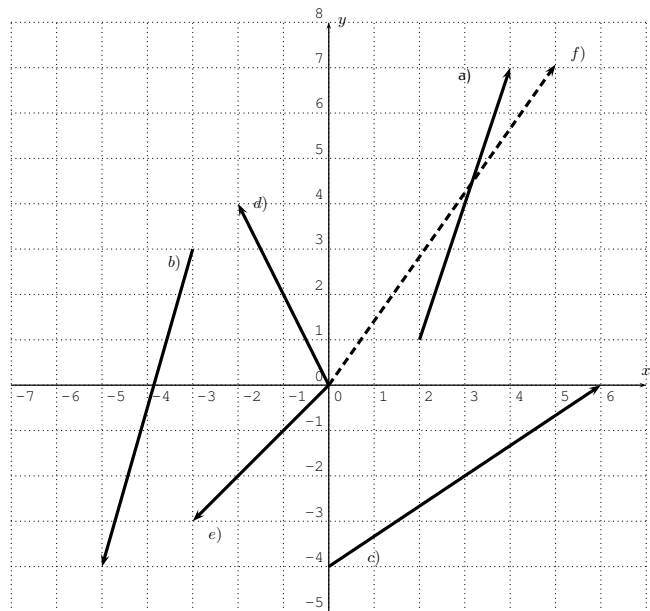

- Exercise 22.2 a) $10, 53^\circ$, b) $\sqrt{29}, 112^\circ$, c) $4\sqrt{2}, 225^\circ$, d) $3\sqrt{2}, -45^\circ$, e) $2\sqrt{2}, -45^\circ$, f) $8, 30^\circ$, g) $2, 210^\circ$, h) $8, 120^\circ$, i) $4, 210^\circ$, j) $5, 37^\circ$, k) $9\sqrt{2}, 135^\circ$
- Exercise 22.3 a) $\langle 15, 10 \rangle$, b) $\langle -2, 8 \rangle$, c) $\langle 15, 14 \rangle$, d) $\langle 8, 4 \rangle$, e) $\langle 13, 5 \rangle$, f) $\langle 23, 41 \rangle$, g) $\langle 16, 20 \rangle$, h) $\langle -16, 25 \rangle$, i) $\langle -\frac{2}{3}, -\frac{25}{6} \rangle$, j) $\langle 6, -4 \rangle$, k) $\langle -2, 1 \rangle$, l) $\langle 0, -2 \rangle$, m) $\langle 43, 12 + 7\sqrt{3} \rangle$, n) $\langle -5, -10 \rangle$, o) $\langle -18, 20 \rangle$, p) $\langle 8\sqrt{5}, -10 \rangle$
- Exercise 22.4 a) $\langle \frac{4}{5}, -\frac{3}{5} \rangle$, b) $\langle -\frac{3}{4}, -\frac{\sqrt{7}}{4} \rangle$, c) $\langle \frac{9\sqrt{85}}{85}, \frac{2\sqrt{85}}{85} \rangle$, d) $\langle -\frac{\sqrt{5}}{6}, \frac{\sqrt{31}}{6} \rangle$, e) $\langle \frac{5\sqrt{70}}{70}, \frac{3\sqrt{14}}{14} \rangle$, f) $\langle 0, -1 \rangle$
- Exercise 22.5 a) $\vec{v} = \langle 1, 3\sqrt{3} \rangle$, $\|\vec{v}\| = 2\sqrt{7}$, $\theta \approx 79^\circ$ b) $\vec{v} \approx \langle -.772, 1.594 \rangle$, $\|\vec{v}\| \approx 7.63$, $\theta \approx 116^\circ$ c) $\vec{v} = \langle -4\sqrt{2}, -4\sqrt{2} \rangle$, $\|v\| = 8$, $\theta = 225^\circ = \frac{5\pi}{4}$

Session 23 (exercises starting on page 323):

- Exercise 23.1 a) 3, 6, 9, 12, 15, 18, 21, b) 8, 13, 18, 23, 28, 33, 38, c) 3, 6, 11, 18, 27, 38, 51, d) 1, 2, 3, 4, 5, 6, 7, e) 1, -1, 1, -1, 1, -1, 1, f) $\sqrt{2}, \frac{\sqrt{3}}{2}, \frac{2}{3}, \frac{\sqrt{5}}{4}, \frac{\sqrt{6}}{5}, \frac{\sqrt{7}}{6}, \frac{\sqrt{8}}{7}$, g) 10, 100, 1000, 10000, 100000, 1000000, 10000000, h) 4, 6, 4, 6, 4, 6, 4
- Exercise 23.2 a) 5, 8, 11, 14, 17, b) 7, 70, 700, 7000, 70000, c) 1, 3, 7, 15, 31, d) 6, 4, -2, -6, -4,
- Exercise 23.3 a) 50, b) 15, c) 30, d) -3, e) 26, f) $\frac{77}{60}$
- Exercise 23.4 For the convenience of those who prefer to use $a_n = a + b \cdot n$ as standard form we have provided answers also in that form.
 a) $5 + 3(n - 1) = 2 + 3n$, b) $-10 + 3(n - 1) = -13 + 3n$ c) no, d) no, e) $73.4 - 21.7(n - 1) = 95.1 - 21.7n$, f) no, g) $4 + 0 \cdot (n - 1) = 4 + 0 \cdot n$, h) $-2.72 - .1(n - 1) = -2.62 - .1n$, i) no, j) $-\frac{3}{5} + \frac{1}{2}(n - 1) = -\frac{11}{10} + \frac{1}{2}n$, k) $9 + 5(n - 1) = 4 + 5n$, l) $-3 + 2(j - 1) = -5 + 2j$, m) no, n) $29 + 16(k - 1) = 13 + 16k$
- Exercise 23.5 a) $57 + 4(n - 8) = 29 + 4(n - 1) = 25 + 4n$, b) $-70 - 3(n - 99) = 224 - 3(n - 1) = 227 - 3n$, c) $14 - 5(n - 1) = 19 - 5n$, d) $-80 + 76(n - 1) = -156 + 76n$, e) $10 - 3(n - 3) = 16 - 3(n - 1) = 19 - 3n$, f) $2 + \frac{3}{4}(n - 20) = -49/4 + \frac{3}{4}(n - 1) = -13 + \frac{3}{4}n$
- Exercise 23.6 a) 116, b) 187, c) $-\frac{3621}{8}$, d) 71
- Exercise 23.7 a) 5,040, b) -1, 113, c) 49, 599, d) -21, 900, e) 10, 100, f) -11, 537, g) 123, 150, h) 424, i) -1762.2, j) 302, 232, k) 200

Session 24 (exercises starting on page 334):

- Exercise 24.1 a) geometric, $7 \cdot 2^{n-1}$, b) geometric, $3 \cdot (-10)^{n-1}$, c) geometric, $81(\frac{1}{3})^{n-1}$, d) arithmetic, $-7 + 2(n - 1) = -9 + 2n$, e) geometric, $-6(-\frac{1}{3})^{n-1}$, f) geometric, $-2(\frac{2}{3})^{n-1}$, g) geometric, $\frac{1}{2}(\frac{1}{2})^{n-1}$, h) both, $2 = 2 + 0(n - 1) = 2(1)^{n-1}$, i) neither, j) geometric, $-2(-1)^{n-1}$, k) arithmetic, $5(n - 1)$, l) geometric, $5(\frac{1}{3})^{n-1}$, m) geometric, $\frac{1}{2}(\frac{1}{2})^{n-1}$, n) neither, o) geometric, $-4(4)^{n-1}$, p) arithmetic, $-4 - 4(n - 1) = -4n$, q) geometric, $-18(-9)^{n-1}$, r) geometric, $\frac{1}{3}(\frac{1}{3})^{n-1}$, s) geometric, $-\frac{5}{7}(\frac{5}{7})^{n-1}$, t) geometric, $-\frac{5}{7}(-\frac{5}{7})^{n-1}$, u) neither, v) arithmetic, $4 + 3(n - 1) = 1 + 3n$
- Exercise 24.2 a) 375, b) 6.25, c) $-7 \cdot 2^{n-1}$, d) 6, e) $\frac{9}{10}(100)^{n-1}$, f) $20 \cdot (5)^{n-1}$, g) $\frac{1}{8}(\frac{3}{8})^{n-1}$, h) $4 \cdot 3^{n-1}$, i) $-40000000000(-\frac{1}{10})^{n-1}$

Exercise 24.3 a) 425, b) $\frac{127}{128}$, c) $-\frac{521}{3125}$, d) 2999997, e) 242, f) 910, g) $-960, 800$, h) $\frac{25,575}{64}$, i) 200

Exercise 24.4 a) 9, b) $-\frac{7}{6}$, c) 3, d) -8 , e) 99, f) $\frac{81}{2}$, g) $-\frac{4}{3}$, h) -9 , i) $\frac{500}{3}$, j) $-\frac{81}{2}$

Exercise 24.5 a) $\frac{4}{9}$, b) $\frac{7}{9}$, c) $\frac{50}{9}$, d) $\frac{23}{99}$, e) $\frac{1300}{33}$, f) $\frac{248}{999}$, g) $\frac{20000}{999}$, h) $\frac{560}{1111}$

Session 25 (exercises starting on page 345):

Exercise 25.1 a) 120, b) 6, c) 362880, d) 2, e) 1, f) 1, g) $\approx 1.216 \cdot 10^{17}$, h) $\approx 1.269 \cdot 10^{89}$, i) 10, j) 84, k) 12, l) 1, m) 23, n) 50388, o) 78, p) 4368

Exercise 25.2 a) $m^4 + 4m^3n + 6m^2n^2 + 4mn^3 + n^4$, b) $x^5 + 10x^4 + 40x^3 + 80x^2 + 80x + 32$, c) $x^6 - 6x^5y + 15x^4y^2 - 20x^3y^3 + 15x^2y^4 - 6xy^5 + y^6$, d) $-p^5 - 5p^4q - 10p^3q^2 - 10p^2q^3 - 5pq^4 - q^5$

Exercise 25.3 a) $x^3 - 6x^2y + 12xy^2 - 8y^3$, b) $x^4 - 40x^3 + 600x^2 - 4000x + 10000$, c) $x^{10}y^5 + 5x^8y^6 + 10x^6y^7 + 10x^4y^8 + 5x^2y^9 + y^{10}$, d) $16y^8 - 160x^4y^6 + 600x^8y^4 - 1000x^{12}y^2 + 625x^{16}$, e) $x^3 + 3x^{\frac{5}{2}} + 3x^2 + x^{\frac{3}{2}}$, f) $-32\frac{x^{10}}{y^5} - 80\frac{x^7}{y} - 80x^4y^3 - 40xy^7 - 10\frac{y^{11}}{x^2} - \frac{y^{15}}{x^5}$, g) $38\sqrt{2} - 36\sqrt{3}$, h) $-2 - 2i$

Exercise 25.4 a) $x^5y^5 - 20x^5y^4 + 160x^5y^3$, b) $512a^{18} + 2304a^{16}b^3$, c) $-189x^{10}y^4 + 21x^{12}y^2 - x^{14}$, d) $\frac{x^{10}}{y^{10}} - 10\frac{x^8}{y^8} + 45\frac{x^6}{y^6}$, e) $\frac{5}{2}m^9n^9 + \frac{15}{16}m^6n^{10} + \frac{3}{16}m^3n^{11} + \frac{1}{64}n^{12}$

Exercise 25.5 a) $35x^3y^4$, b) $36x^{14}y^2$, c) $-220w^9$, d) $280x^7y^4$, e) $15625b^6$, f) $-189p^9q^{15}$, g) $\frac{715}{2}b^9$

Exercise 25.6 a) $84x^3y^6$, b) $15r^4s^4$, c) $-330x^4$, d) $500x^3y^6$, e) $80x^7$, f) $2i$

Review of part V (exercises starting on page 347):

Exercises V 1. $4 + i4\sqrt{3}$, 2. $\frac{\sqrt{3}}{10} - i\frac{1}{10}$, 3. magnitude $\|\langle -7, -7\sqrt{3} \rangle\| = 14$, directional angle $\theta = \frac{4\pi}{3} = 240^\circ$, 4. a) geometric $a_n = 54 \cdot (-\frac{1}{3})^{n-1}$, b) neither, c) arithmetic $a_n = 9 - 2 \cdot (n - 1)$, 5. 19950, 6. -1785 , 7. 64, 8. $27x^6 - 54x^5y + 36x^4y^2 - 8x^3y^3$, 9. $a^9b^{18} + 90a^7b^{16} + 3600a^5b^{14}$, 10. $-7000p^3q^{10}$

References

The topics in this book are all standard and can be found in many precalculus textbooks. In particular, the precalculus textbooks below can be consulted for further reading.

1. Robert F. Blitzer, *Precalculus*, 4th edition, Prentice Hall
2. Thomas W. Hungerford, Douglas J. Shaw, *Contemporary Precalculus: A Graphing Approach*, 5th edition, Brooks Cole
3. Ron Larson, *Precalculus*, 8th edition, Brooks Cole
4. David Lippman, Melonie Rasmussen, *Precalculus: An Investigation of Functions*, available on www.opentextbookstore.com/precalc
5. Revathi Narasimhan, *Precalculus: Building Concepts and Connections*, Instructor's edition, Houghton Mifflin
6. Fred Safier, *Schaum's Outline of PreCalculus*, 2nd edition, Schaum's Outline Series, McGraw-Hill
7. Karl J. Smith, *Precalculus: A Functional Approach To Graphing And Problem Solving*, 6th edition, Jones & Bartlett Learning
8. James Stewart, Lothar Redlin, Saleem Watson, *Precalculus: Mathematics for Calculus*, 6th edition, Brooks Cole

Here are some books on calculus, which should be accessible to the reader after finishing this book.

1. Ron Larson, Bruce H. Edwards, *Calculus*, 9th edition, Brooks Cole
2. Jon Rogawski, *Calculus*, 2nd edition, W. H. Freeman
3. James Stewart, *Calculus*, 6th edition, Brooks Cole

Important formulas used in precalculus

Algebraic formulas

Quadratic formula: The solutions of $ax^2 + bx + c = 0$ are:

$$x_{1/2} = \frac{-b \pm \sqrt{b^2 - 4ac}}{2a}$$

Remainder theorem:

Dividing a polynomial $f(x)$ by $(x - c)$ has a remainder of $r = f(c)$.

In particular: $g(x) = x - c$ is a factor of $f(x) \iff f(c) = 0$

Rational root theorem: The rational solutions of $a_n x^n + a_{n-1} x^{n-1} + \dots + a_1 x + a_0 = 0$ (with $a_0 \neq 0$ and $a_n \neq 0$) are of the form $x = \frac{p}{q}$ where p is a factor of a_0 , and q is a factor of a_n .

Fundamental theorem of algebra:

Every non-constant polynomial has a root.

Exponential and logarithmic formulas:

$$\begin{aligned} b^x \cdot b^y &= b^{x+y} \\ \frac{b^x}{b^y} &= b^{x-y} \\ (b^x)^n &= b^{n \cdot x} \end{aligned}$$

$$\begin{aligned} \log_b(x \cdot y) &= \log_b(x) + \log_b(y) \\ \log_b\left(\frac{x}{y}\right) &= \log_b(x) - \log_b(y) \\ \log_b(x^n) &= n \cdot \log_b(x) \\ \log_b(x) &= \frac{\log(x)}{\log(b)} \end{aligned}$$

Applications of exponential and logarithmic functions:

Rate of growth: $y = c \cdot b^x$ where $b = 1 + r$
 Half-life: $y = c \cdot \left(\frac{1}{2}\right)^{\frac{x}{h}}$ where h is the half-life
 Compound interest: $A = P \cdot \left(1 + \frac{r}{n}\right)^{n \cdot t}$ (compounded n times per year)
 Compound interest: $A = P \cdot e^{r \cdot t}$ (continuous compounding)

Complex numbers $z = a + bi$: $i^2 = -1$

Absolute value: $|a + bi| = \sqrt{a^2 + b^2}$

Polar form: $a + bi = r \cdot (\cos(\theta) + i \cdot \sin(\theta))$

where $r = \sqrt{a^2 + b^2}$ and $\tan(\theta) = \frac{b}{a}$

Multiplication: $r_1(\cos(\theta_1) + i \sin(\theta_1)) \cdot r_2(\cos(\theta_2) + i \sin(\theta_2))$
 $= r_1 r_2 \cdot (\cos(\theta_1 + \theta_2) + i \sin(\theta_1 + \theta_2))$

Division: $\frac{r_1(\cos(\theta_1) + i \sin(\theta_1))}{r_2(\cos(\theta_2) + i \sin(\theta_2))} = \frac{r_1}{r_2} \cdot (\cos(\theta_1 - \theta_2) + i \sin(\theta_1 - \theta_2))$

Vectors $\vec{v} = \langle a, b \rangle$:

Magnitude: $\|\langle a, b \rangle\| = \sqrt{a^2 + b^2}$

Directional angle: $\tan(\theta) = \frac{b}{a}$

Scalar multiplication: $r \cdot \langle a, b \rangle = \langle r \cdot a, r \cdot b \rangle$

Vector addition: $\langle a, b \rangle + \langle c, d \rangle = \langle a + c, b + d \rangle$

Arithmetic and geometric series:

	arithmetic sequence	geometric sequence
n th term	$a_n = a_1 + d \cdot (n - 1)$	$a_n = a_1 \cdot r^{n-1}$
series $a_1 + \dots + a_k$	$\sum_{i=1}^k a_i = \frac{k}{2} \cdot (a_1 + a_k)$	$\sum_{i=1}^k a_i = a_1 \cdot \frac{1-r^{k+1}}{1-r}$
infinite series	—	$\sum_{i=1}^{\infty} a_i = a_1 \cdot \frac{1}{1-r}$

Binomial formula:

$$(a + b)^n = \sum_{r=0}^n \binom{n}{r} \cdot a^{n-r} \cdot b^r$$

where $\binom{n}{r} = \frac{n!}{r! \cdot (n-r)!}$,
 and $k! = 1 \cdot 2 \cdot \dots \cdot k$

The k th term is $\binom{n}{k-1} a^{n-k+1} b^{k-1}$.

Graphs of basic functions

Lines:

Slope-intercept form of the line:

$$y = m \cdot x + b$$

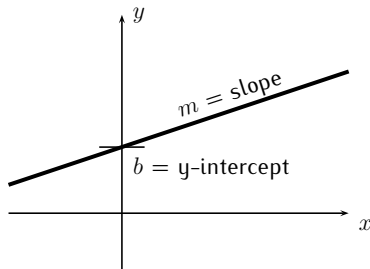

Slope:

$$m = \frac{y_2 - y_1}{x_2 - x_1}$$

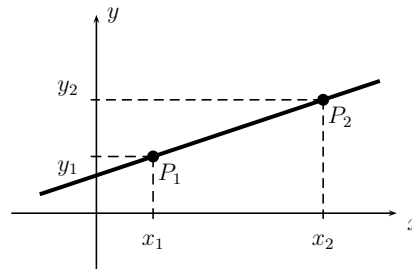

Line $y = mx + b$:

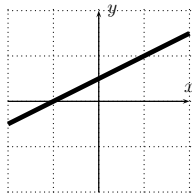

$$m > 0$$

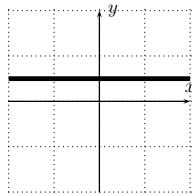

$$m = 0$$

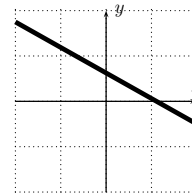

$$m < 0$$

Absolute value and square root:

$$y = |x|$$

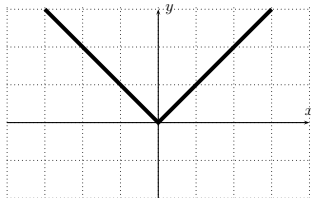

$$y = \sqrt{x}$$

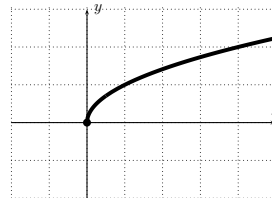

Polynomials and rational functions:

$$y = x^2$$

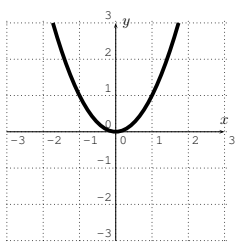

$$y = x^3$$

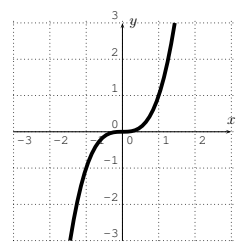

$$y = \frac{1}{x}$$

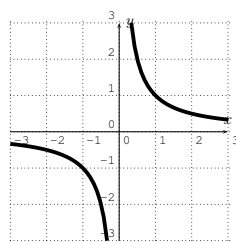

$$y = \frac{1}{x^2}$$

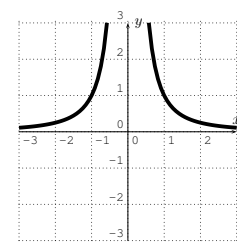

Exponential and logarithmic functions:

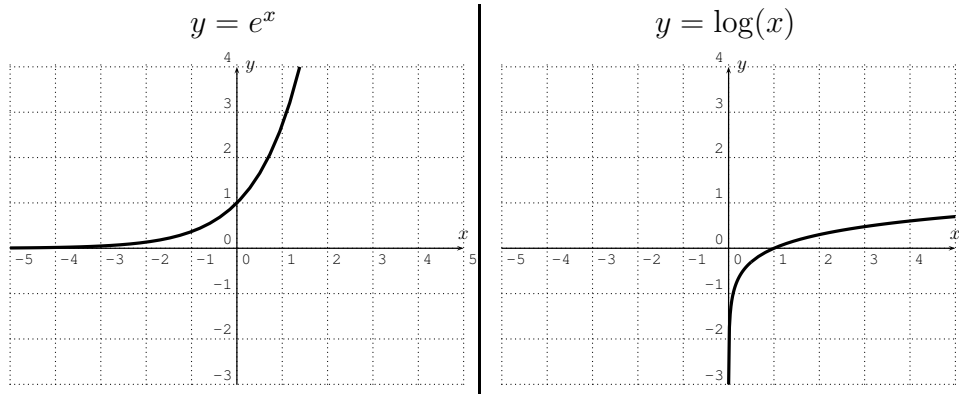

Trigonometric and inverse trigonometric functions:

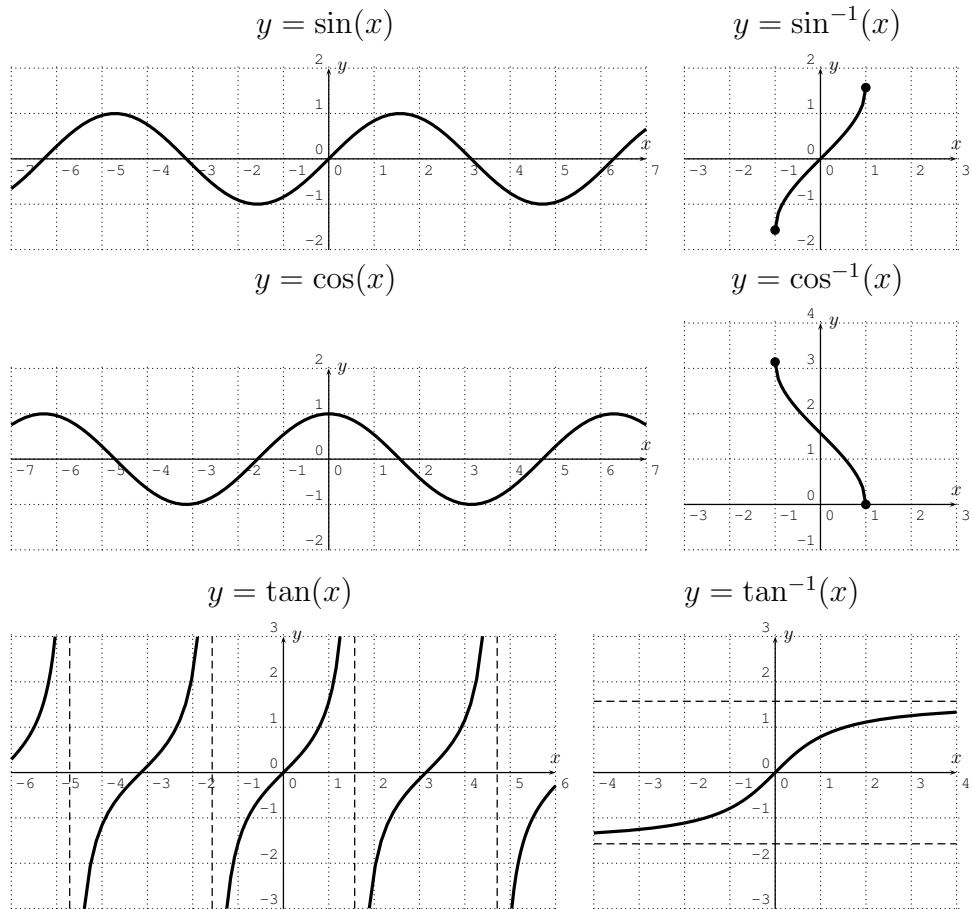

$$f(x) = a \cdot \sin(b \cdot x + c) \quad \text{or} \quad f(x) = a \cdot \cos(b \cdot x + c)$$

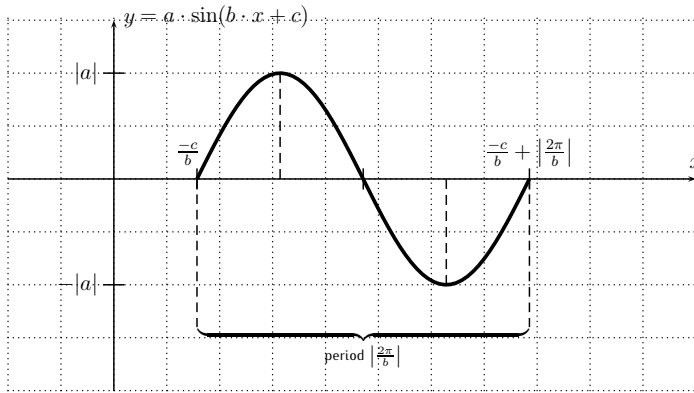

$|a|$ = amplitude

$|\frac{2\pi}{b}|$ = period

$\frac{-c}{b}$ = phase-shift

Trigonometric formulas

Basic facts:

$$\pi = 180^\circ$$

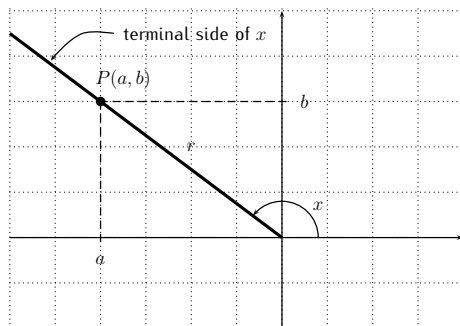
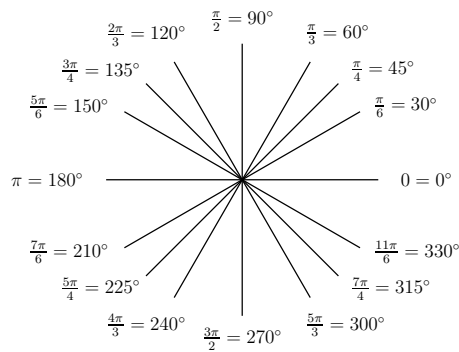

$$a^2 + b^2 = r^2$$

$$\implies r = \sqrt{a^2 + b^2}$$

$\sin(x) = \frac{b}{r}$	$\csc(x) = \frac{r}{b}$
$\cos(x) = \frac{a}{r}$	$\sec(x) = \frac{r}{a}$
$\tan(x) = \frac{b}{a}$	$\cot(x) = \frac{a}{b}$

Quadrant II	Quadrant I
$\sin(x)$ is positive	$\sin(x)$ is positive
$\cos(x)$ is negative	$\cos(x)$ is positive
$\tan(x)$ is negative	$\tan(x)$ is positive
Quadrant III	Quadrant IV
$\sin(x)$ is negative	$\sin(x)$ is negative
$\cos(x)$ is negative	$\cos(x)$ is positive
$\tan(x)$ is positive	$\tan(x)$ is negative

$$\csc(x) = \frac{1}{\sin(x)}, \quad \sec(x) = \frac{1}{\cos(x)}, \quad \tan(x) = \frac{\sin(x)}{\cos(x)}, \quad \cot(x) = \frac{\cos(x)}{\sin(x)}$$

$$\sin^2(x) + \cos^2(x) = 1, \quad \sec^2(x) = 1 + \tan^2(x)$$

$$\sin(x + 2\pi) = \sin(x), \quad \sin(-x) = -\sin(x), \quad \sin(\pi - x) = \sin(x)$$

$$\cos(x + 2\pi) = \cos(x), \quad \cos(-x) = \cos(x), \quad \cos(\pi - x) = -\cos(x)$$

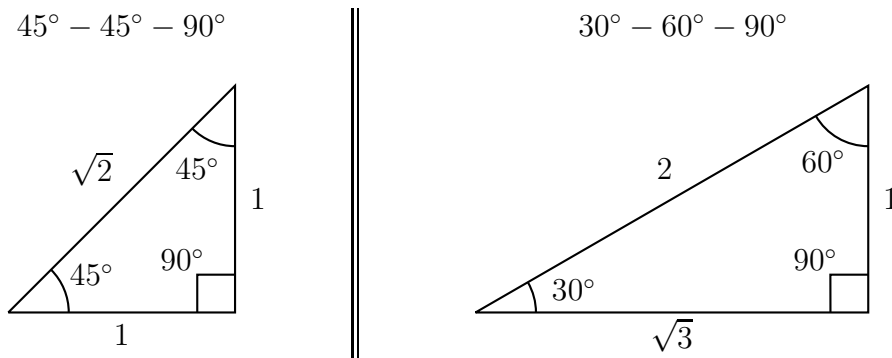

x	$0 = 0^\circ$	$\frac{\pi}{6} = 30^\circ$	$\frac{\pi}{4} = 45^\circ$	$\frac{\pi}{3} = 60^\circ$	$\frac{\pi}{2} = 90^\circ$
$\sin(x)$	0	$\frac{1}{2}$	$\frac{\sqrt{2}}{2}$	$\frac{\sqrt{3}}{2}$	1
$\cos(x)$	1	$\frac{\sqrt{3}}{2}$	$\frac{\sqrt{2}}{2}$	$\frac{1}{2}$	0
$\tan(x)$	0	$\frac{\sqrt{3}}{3}$	1	$\sqrt{3}$	undef.

Solving trigonometric equations:

Solve: $\sin(x) = c$	Solve: $\cos(x) = c$	Solve: $\tan(x) = c$
First, find one solution, that is: $\sin^{-1}(c)$. Use: $\sin^{-1}(-c) = -\sin^{-1}(c)$	First, find one solution, that is: $\cos^{-1}(c)$. Use: $\cos^{-1}(-c) = \pi - \cos^{-1}(c)$	First, find one solution, that is: $\tan^{-1}(c)$. Use: $\tan^{-1}(-c) = -\tan^{-1}(c)$
The general solution is: $x = (-1)^n \sin^{-1}(c) + n\pi$ where $n = 0, \pm 1, \pm 2, \dots$	The general solution is: $x = \pm \cos^{-1}(c) + 2n\pi$ where $n = 0, \pm 1, \pm 2, \dots$	The general solution is: $x = \tan^{-1}(c) + n\pi$ where $n = 0, \pm 1, \pm 2, \dots$

Addition and subtraction of angles:

$$\begin{aligned}\sin(\alpha + \beta) &= \sin \alpha \cos \beta + \cos \alpha \sin \beta \\ \sin(\alpha - \beta) &= \sin \alpha \cos \beta - \cos \alpha \sin \beta \\ \cos(\alpha + \beta) &= \cos \alpha \cos \beta - \sin \alpha \sin \beta \\ \cos(\alpha - \beta) &= \cos \alpha \cos \beta + \sin \alpha \sin \beta \\ \tan(\alpha + \beta) &= \frac{\tan \alpha + \tan \beta}{1 - \tan \alpha \tan \beta} \\ \tan(\alpha - \beta) &= \frac{\tan \alpha - \tan \beta}{1 + \tan \alpha \tan \beta}\end{aligned}$$

Half-angles and multiple angles:

$$\begin{aligned}\sin \frac{\alpha}{2} &= \pm \sqrt{\frac{1 - \cos \alpha}{2}} \\ \cos \frac{\alpha}{2} &= \pm \sqrt{\frac{1 + \cos \alpha}{2}} \\ \tan \frac{\alpha}{2} &= \frac{1 - \cos \alpha}{\sin \alpha} = \frac{\sin \alpha}{1 + \cos \alpha} = \pm \sqrt{\frac{1 - \cos \alpha}{1 + \cos \alpha}} \\ \sin(2\alpha) &= 2 \sin \alpha \cos \alpha \\ \cos(2\alpha) &= \cos^2 \alpha - \sin^2 \alpha = 1 - 2 \sin^2 \alpha = 2 \cos^2 \alpha - 1 \\ \tan(2\alpha) &= \frac{2 \tan \alpha}{1 - \tan^2 \alpha}\end{aligned}$$

The signs “ \pm ” in the half-angle formulas above are determined by the quadrant in which the angle $\frac{\alpha}{2}$ lies.

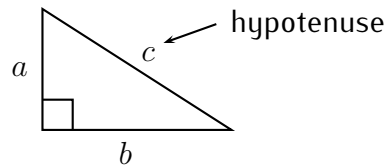
Geometric formulas**Pythagorean Theorem:**

$$a^2 + b^2 = c^2$$

2-dimensional (planar) geometric shapes:

Circle

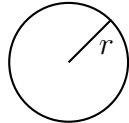

$$\text{Area } A = \pi r^2$$

$$\text{Circumference } C = 2\pi r$$

Square

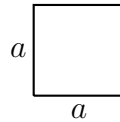

$$\text{Area } A = a^2$$

$$\text{Perimeter } P = 4a$$

Rectangle

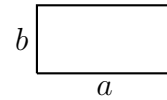

$$\text{Area } A = a \cdot b$$

$$\text{Perimeter } P = 2a + 2b$$

Triangle

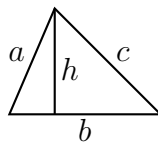

$$\text{Area } A = \frac{1}{2}bh$$

$$\text{Perimeter } P = a + b + c$$

Parallelogram

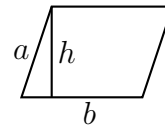

$$\text{Area } A = bh$$

$$\text{Perimeter } P = 2a + 2b$$

Index

- 10^n , 203
- $30^\circ - 60^\circ - 90^\circ$ triangle, 235
- $45^\circ - 45^\circ - 90^\circ$ triangle, 235
- ${}_nC_r$, 338
- \mathbb{C} , 287
- \mathbb{N} , 2
- \mathbb{Q} , 2
- \mathbb{R} , 2
- \mathbb{R}^2 , 299
- \mathbb{Z} , 2
- $\arccos(x)$, 267
- $\arcsin(x)$, 265
- $\arctan(x)$, 263
- $\binom{n}{r}$, 338
- $\cos(x)$, 233
- $\cos^{-1}(x)$, 267
- cosh, 188
- $\cot(x)$, 233, 263
- $\csc(x)$, 233
- $\lfloor x \rfloor$, 27
- $\sec(x)$, 233
- $\sin(x)$, 233
- $\sin^{-1}(x)$, 265
- sinh, 197
- \sum , 316
- $\tan(x)$, 233
- $\tan^{-1}(x)$, 263
- tanh, 197
- \vec{v} , 299
- $\{a_n\}$, 311
- $\{a_n\}_{n \geq 1}$, 311
- e , 187
- $n!$, 337
- n factorial, 337
- n -choose- r , 338
- n th root, 225
- absolute value, 3, 62, 63, 289
- addition of angles formula for trigonometric functions, 252
- angle, 232
- arccosine, 267
- arcsine, 265
- arctangent, 263
- arithmetic sequence, 318
- arithmetic series, 321
- asymptote, 118, 147, 148
- base, 184, 191
- binomial coefficient, 338
- binomial theorem, 341
- carbon dating method, 219
- carbon-14, 219
- codomain, 22
- coefficients, 101
- combination, 339
- common difference, 318
- common ratio, 325
- complex conjugate, 140
- complex number, 287

- absolute value, 289
- imaginary part, 287
- polar form, 290
- real part, 287
- complex numbers, 134
- complex plane, 288
- complex unit, 287
- compound interest, 216
- compounded n times per year, 222
- compounded quarterly, 221
- compounding, 222
- conjugate, 140
- continuous compounding, 222
- cosecant $\csc(x)$, 233
- cosine $\cos(x)$, 233
- cotangent $\cot(x)$, 233, 263

- degree, 101
- degree measure, 232
- dependent variable, 28
- difference quotient, 34
- directional angle, 299
- dividend, 104
- divisor, 104
- domain, 22, 36
- double angle formula for trigonometric functions, 257

- Euler number, 187
- even function, 71, 242
- exponential function, 184
- extrema, 114
- extremum, 53, 114

- factor theorem, 107
- factorial, 337
- Fibonacci sequence, 312
- floor function, 27
- frequency, 246

- function, 22
 - arccosine, 267
 - arcsine, 265
 - arctangent, 263
 - composition, 78
 - domain, 22, 36
 - exponential, 184
 - floor, 27
 - graph, 37
 - injective, 86
 - inverse cosine, 267
 - inverse function, 89
 - inverse sine, 265
 - inverse tangent, 263
 - logarithm, 191
 - one-to-one, 86
 - piecewise defined, 33
 - range, 23, 36
- fundamental theorem of algebra, 135

- geometric sequence, 325
- geometric series, 329
 - infinite, 332
- geometric vector, 299
- graphs
 - $y = \arccos(x)$, 267
 - $y = \arcsin(x)$, 265
 - $y = \arctan(x)$, 263
 - $y = \cos(x)$, 241
 - $y = \cos^{-1}(x)$, 267
 - $y = \frac{1}{x}$, 64
 - $y = \frac{1}{x^n}$, 148
 - $y = \ln(x)$, 193, 197
 - $y = \log(x)$, 193, 197
 - $y = \log_b(x)$, 197
 - $y = \sin(x)$, 241
 - $y = \sin^{-1}(x)$, 265
 - $y = \sqrt{x}$, 64

- $y = \tan(x)$, 243
- $y = \tan^{-1}(x)$, 263
- $y = b^x$, 186
- $y = c \cdot 2^x$, 189
- $y = e^x$, 187
- $y = x^2$, 64
- $y = x^3$, 64
- $y = x^n$, 114
- absolute value, 63
- arccosine, 267
- arcsine, 265
- arctangent, 263
- hole, 151
- inverse cosine, 267
- inverse sine, 265
- inverse tangent, 263
- maximum, 53
- minimum, 53
- polynomial degree 2, 114
- polynomial degree 3, 115
- polynomial degree 4, 116
- polynomial degree 5, 116
- rational function, 150
- reflect, 67
- shift, 65, 66
- stretch, compress, 66, 67
- greater than, 4
- half angle formula for trigonometric functions, 257
- half-life, 217
 - carbon-14, 219
- horizontal asymptote, 147, 151
- horizontal line test, 87
- hyperbolic cosine, 188
- hyperbolic sine, 197
- hyperbolic tangent, 197
- hypotenuse, 410
- imaginary, 134
- imaginary unit, 287
- independent variable, 28
- inequality, 10, 169
- infinite geometric series, 332
- infinite series, 332
- injective, 86
- input, 22
- integer, 2
- interest rate, 222
- interval, 5
- inverse function, 89
- irrational number, 3
- leading coefficient, 101
- less than, 4
- line, 13
 - x -intercept, 15
 - y -intercept, 15
 - graphing the line, 16
 - point-slope form of the line, 15
 - slope, 14
 - slope-intercept form of the line, 16
- logarithm, 191
- logarithm change of base, 200
- logarithm properties, 199
- long division, 102
- magnitude, 299
- maximum, 53
- minimum, 53
- monomial, 101
- monthly, 223
- multiplicity, 122, 140
- natural logarithm, 191
- natural number, 2
- newton, 307

- odd function, 71, 242, 243
- one-to-one, 86
- output, 22

- parabola, 114
- Pascal's triangle, 340
- period, 246
- periodic function, 240
- phase shift, 246
- piecewise defined function, 33
- point-slope form of the line, 15
- polynomial, 101
 - degree, 101
- polynomial division, 102
- powers of 10, 203
- present value, 224
- principal, 221, 222
- programming the TI-84 calculator, 366
- Pythagorean theorem, 410

- quadrant, 234
- quadratic formula, 124
- quotient, 104

- radian measure, 232
- range, 23, 36
- rate, 222
- rate of growth, 212
- rational function, 102, 147
 - asymptotic behaviour, 152
- rational number, 2
- rational root theorem, 131
- real number, 2
- real part, 134
- recursive, 315
- remainder, 104
- remainder theorem, 107
- removable discontinuity, 151

- resetting the calculator to factory settings, 373
- root, 53, 101

- scalar multiplication, 303
- secant $\sec(x)$, 233
- sequence, 311
- series, 316
 - arithmetic, 321
 - geometric, 329
 - infinite, 332
 - infinite geometric, 332
- Sigma Σ , 316
- sine $\sin(x)$, 233
- slant asymptote, 150
- slope-intercept form of the line, 16
- solving trigonometric equations, 277
- standard convention of domain, 36
- subtraction of angles formula for trigonometric functions, 252
- summation symbol, 316
- synthetic division, 109

- tangent $\tan(x)$, 233
- telescopic sum, 329
- TI-84, 49
 - (-), 351
 - e , 188
 - n th root, 225, 364
 - absolute value, 62, 63, 364
 - alpha key, 349
 - calculate function values, 54
 - combination, 365
 - degree, 352
 - equation solver, 362
 - exponential function, 188
 - factorial, 364
 - graphing, 49

- graphing functions, 353, 357
- graphing polar coordinates, 360
- insert, 350
- intersecting functions, 358
- intersection points, 61
- line style, 186
- maximum, 53
- minimum, 53
- minus vs. subtract, 50, 351
- permutation, 365
- piecewise defined functions, 359
- prior answer, 350
- prior entry, 350, 352
- programming the calculator, 366
- radian, 352
- rescaling window, 354
- resetting to factory settings, 373
- sequences, 365
- table, 361
- zeros, 53
- zoom window, 354–356
- trigonometric equations, 277
- trigonometric functions
 - addition of angles formula, 252
 - double angle formula, 257
 - exact values, 236
 - half angle formula, 257
 - positive/negative, 234
 - subtraction of angles formula, 252
- union of sets, 8
- unit vector, 304
- vector, 299
 - directional angle, 299
 - magnitude, 299
 - unit vector, 304
 - vector addition, 305
- vector space, 308
- vertical asymptote, 147, 151
- vertical line test, 40
- zero, 53