

11 WALL SECTION DETAIL  
SECTION 11-11

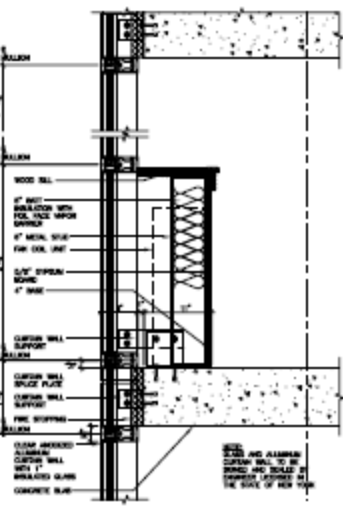

12 WALL SECTION DETAIL  
SECTION 12-12

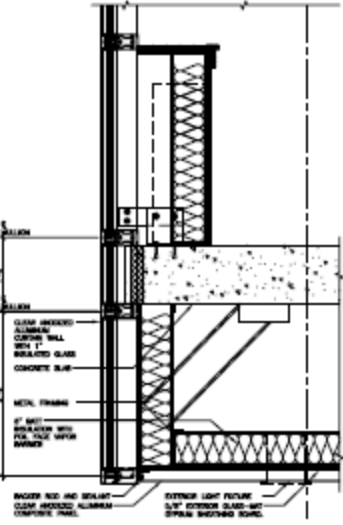

13 WALL SECTION DETAIL  
SECTION 13-13

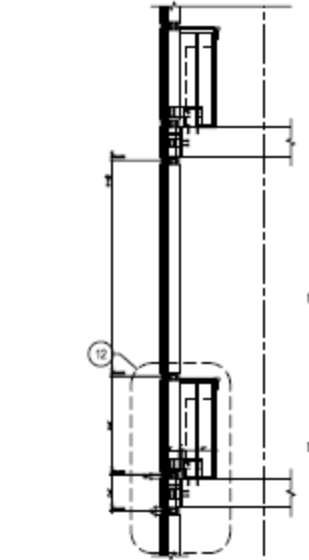

6 PARTIAL WALL SECTION  
SECTION 6-6

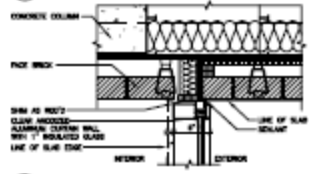

7 PLAN DETAIL (INSIDE CORNER @ BRICK)  
SECTION 7-7

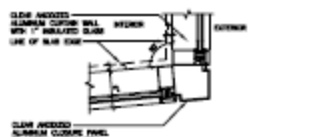

8 PLAN DETAIL (OUTSIDE CORNER)  
SECTION 8-8

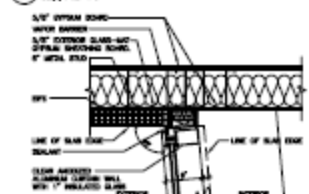

9 PLAN DETAIL (INSIDE CORNER @ GFS)  
SECTION 9-9

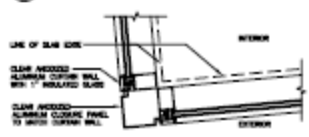

10 PLAN DETAIL (OUTSIDE CORNER)  
SECTION 10-10

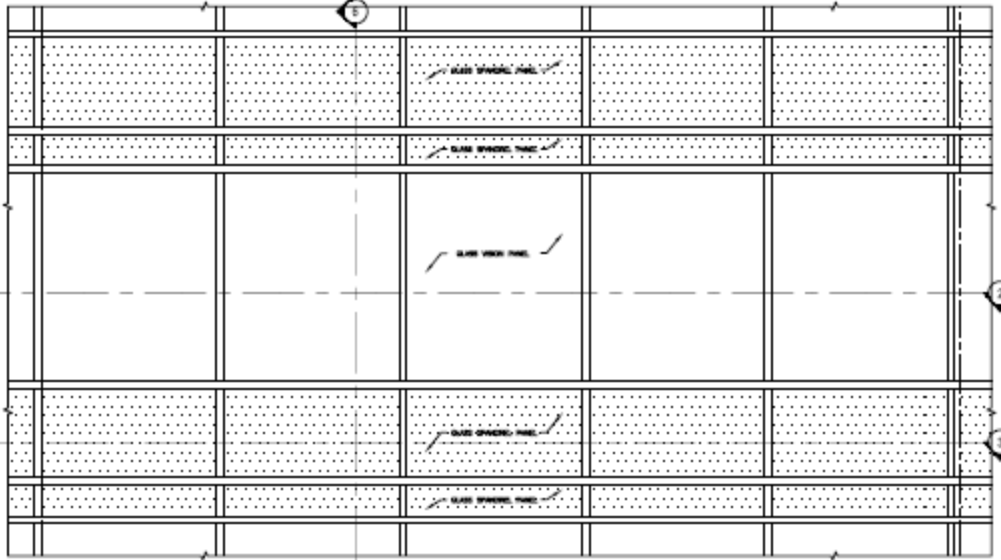

1 PARTIAL ELEVATION (TYPICAL @ BRICK)  
SECTION 1-1

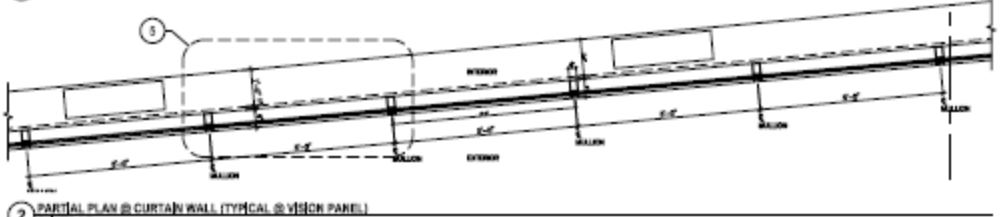

2 PARTIAL PLAN @ CURTAIN WALL (TYPICAL @ VISION PANEL)  
SECTION 2-2

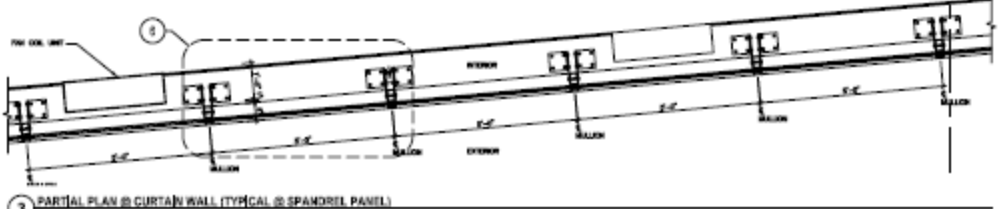

3 PARTIAL PLAN @ CURTAIN WALL (TYPICAL @ SPANDREL PANEL)  
SECTION 3-3

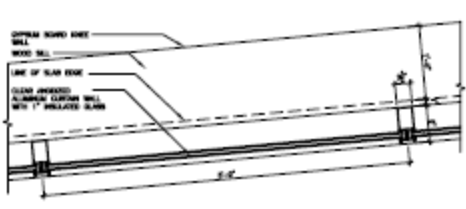

5 PLAN DETAIL (V @ VISION PANEL)  
SECTION 5-5

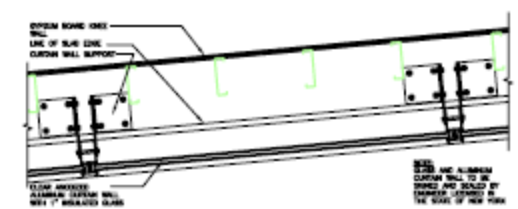

4 PLAN DETAIL (S @ SPANDREL PANEL)  
SECTION 4-4

SEAL: SEAL THE ALUMINUM CURTAIN WALL TO BE DRILLED AND BOLTED BY CONTRACTOR LISTED IN THE GUIDE OF NEW YORK.

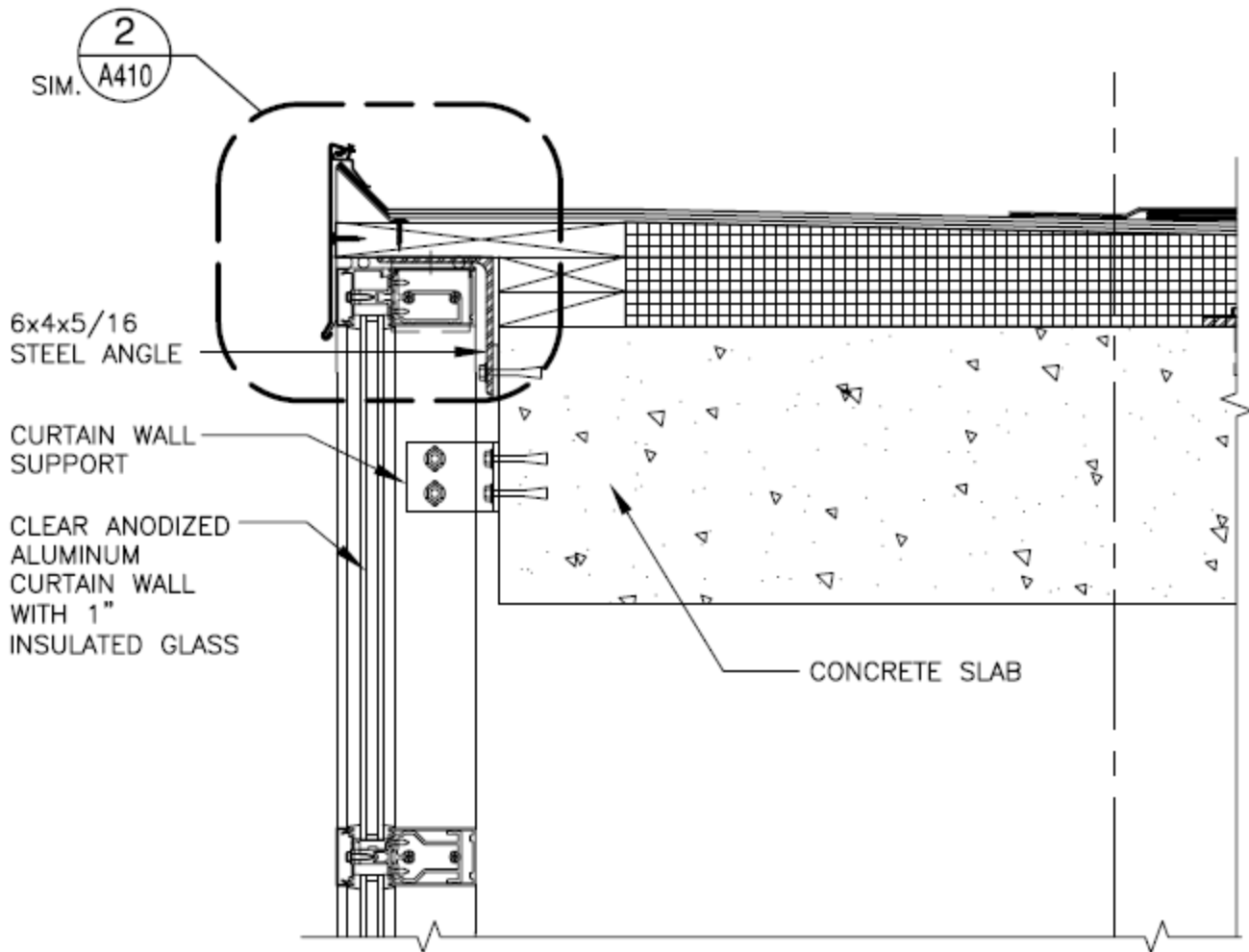

11

## WALL SECTION DETAIL

Scale: 1 1/2"=1'-0"

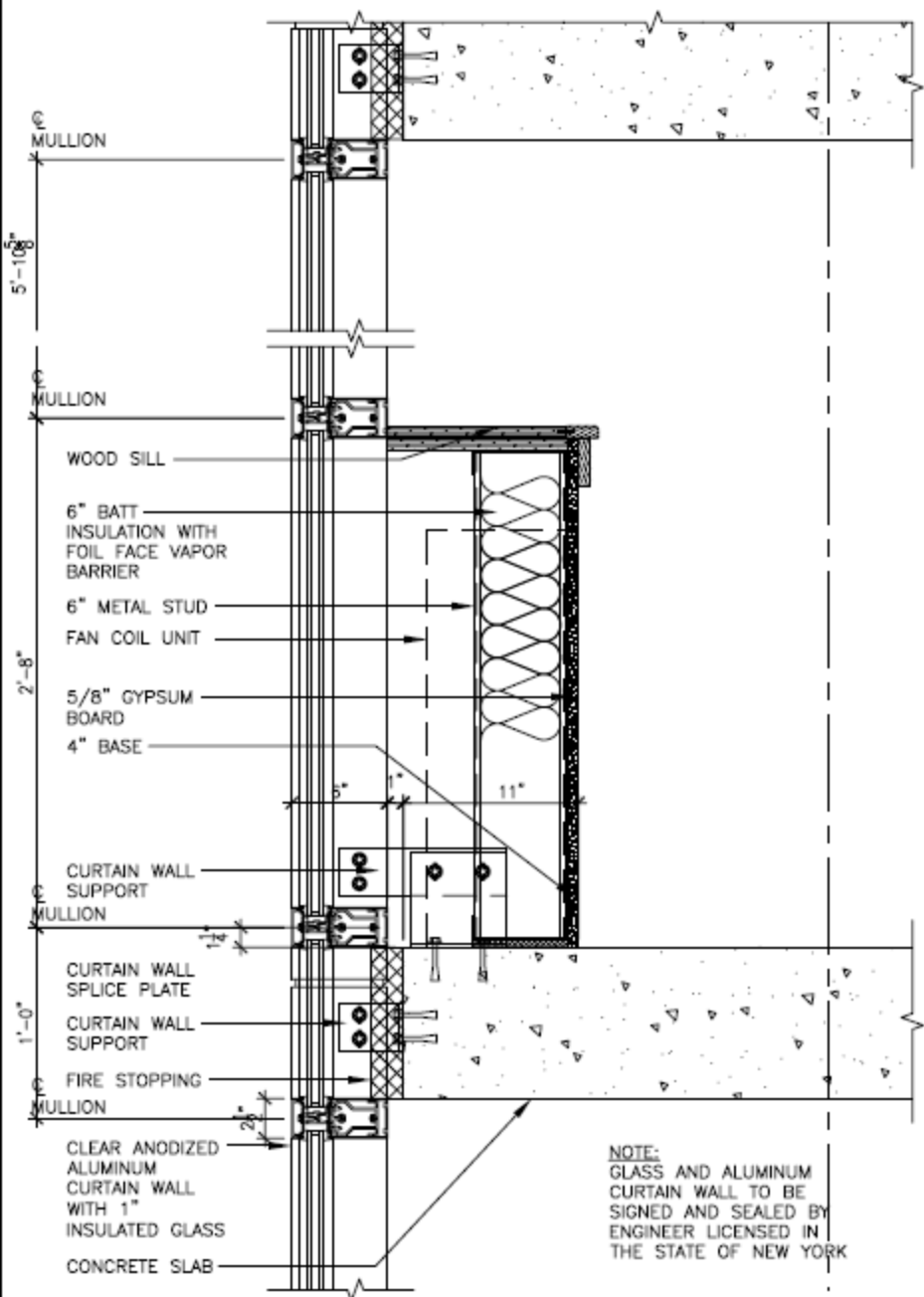

12

## WALL SECTION DETAIL

Scale: 1 1/2"=1'-0"

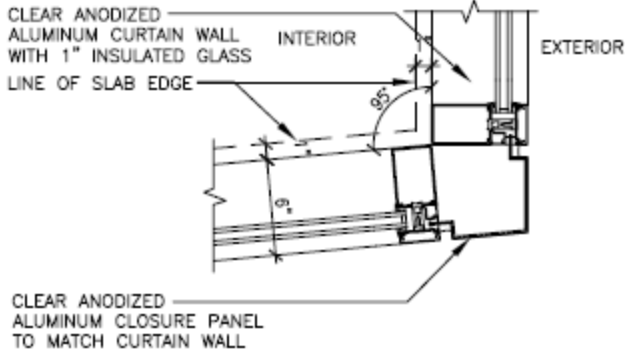

8

## PLAN DETAIL (OUTSIDE CORNER)

Scale: 1 1/2"=1'-0"

GYPSUM BOARD KNEE  
WALL

LINE OF SLAB EDGE

CURTAIN WALL SUPPORT

CLEAR ANODIZED  
ALUMINUM CURTAIN WALL  
WITH 1" INSULATED GLASS

NOTE:  
GLASS AND ALUMINUM  
CURTAIN WALL TO BE  
SIGNED AND SEALED BY  
ENGINEER LICENSED IN  
THE STATE OF NEW YORK

4

**PLAN DETAIL (@ SPANDREL PANEL)**

Scale: 1 1/2"=1'-0"