



# RIBBED PANEL AND STICK CURTAIN WALL

Chenhui Yang  
ARCH 2330  
Prof. Paul King

# PRECAST CONCRETE RIBBED PANEL WALL

---



1. Prevent intrusive noise
2. Texture of the panel can be casted in different shapes and patterns
3. Sandwich concrete wall (2 layers of concrete and 1 layer of insulation in between)
4. Ideal for most buildings
5. Fast-track construction

# PHOTOS



New Street Signal Box  
Architect: Bicknell and Hamilton with R L Moorcraft

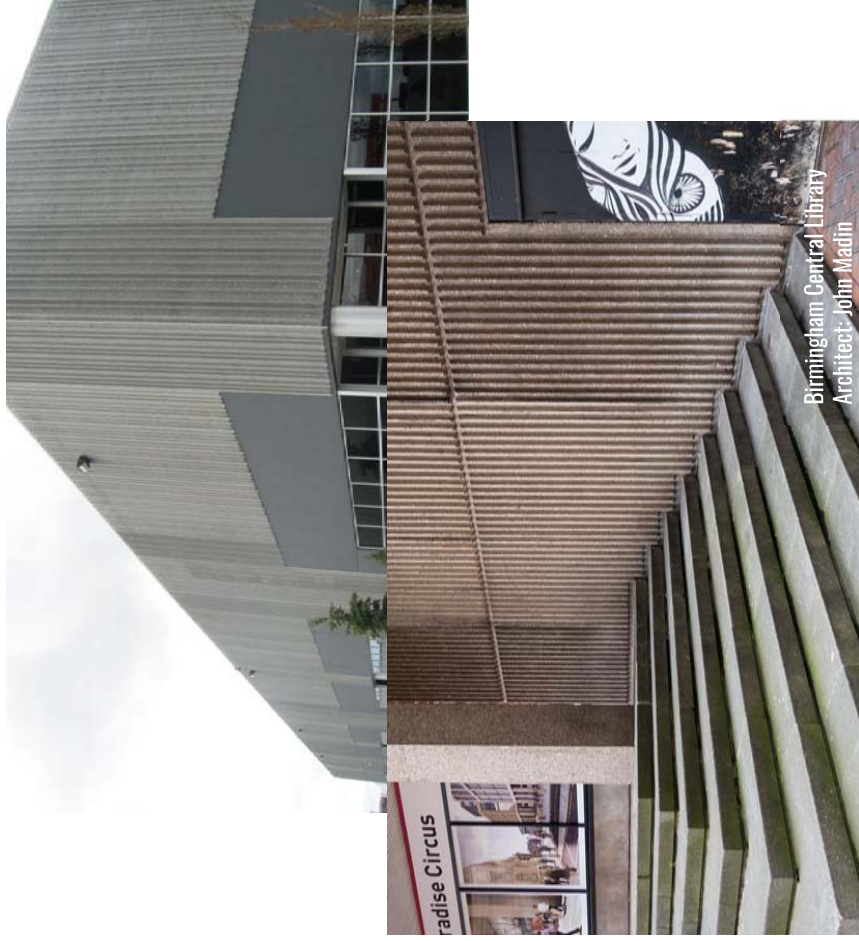

Birmingham Central Library  
Architect: John Madin

# SKETCHES

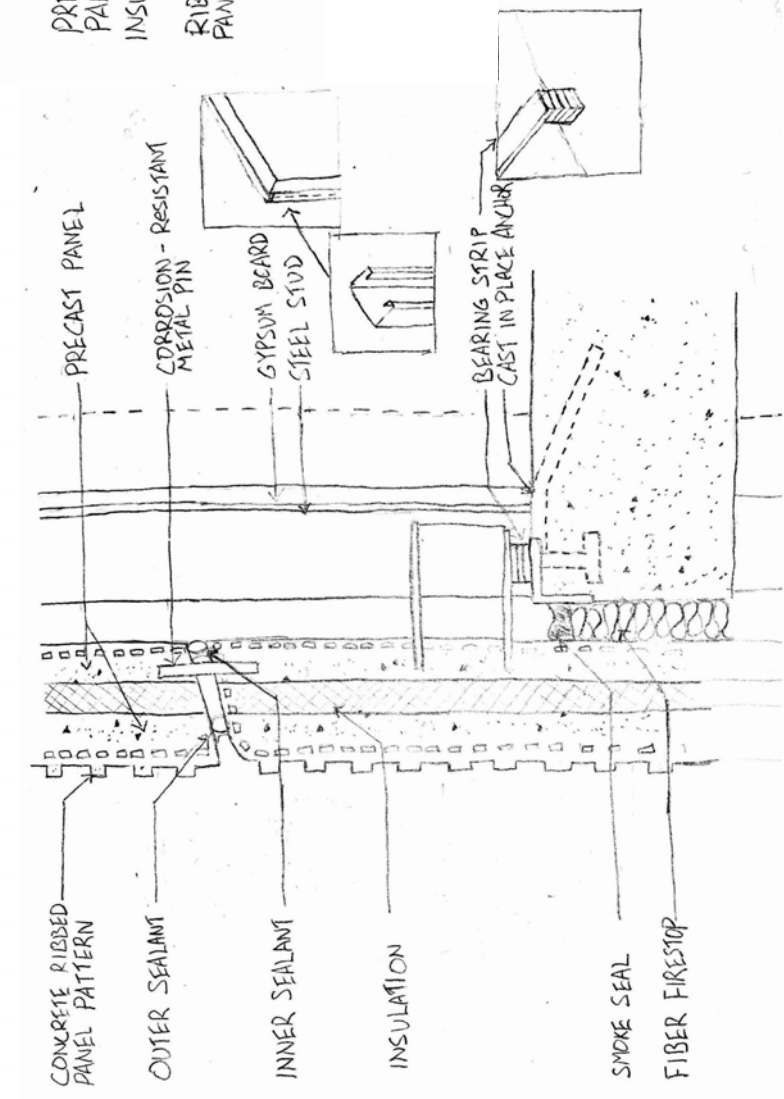

SECTION

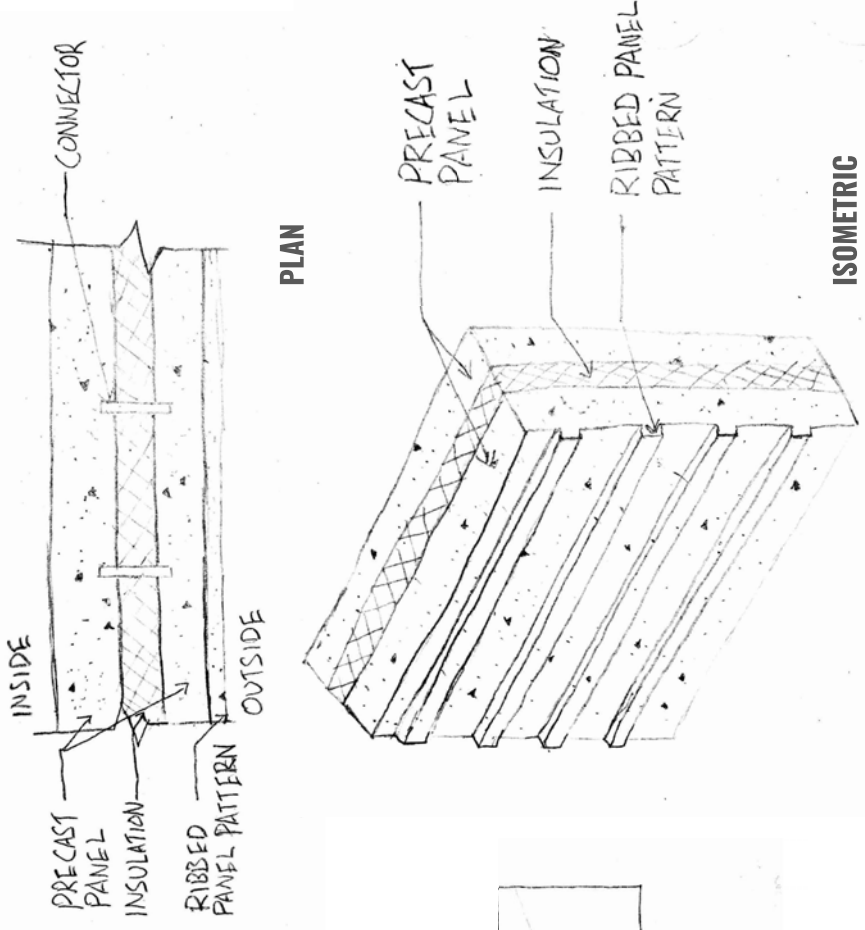

# STICK CURTAIN WALL SYSTEM

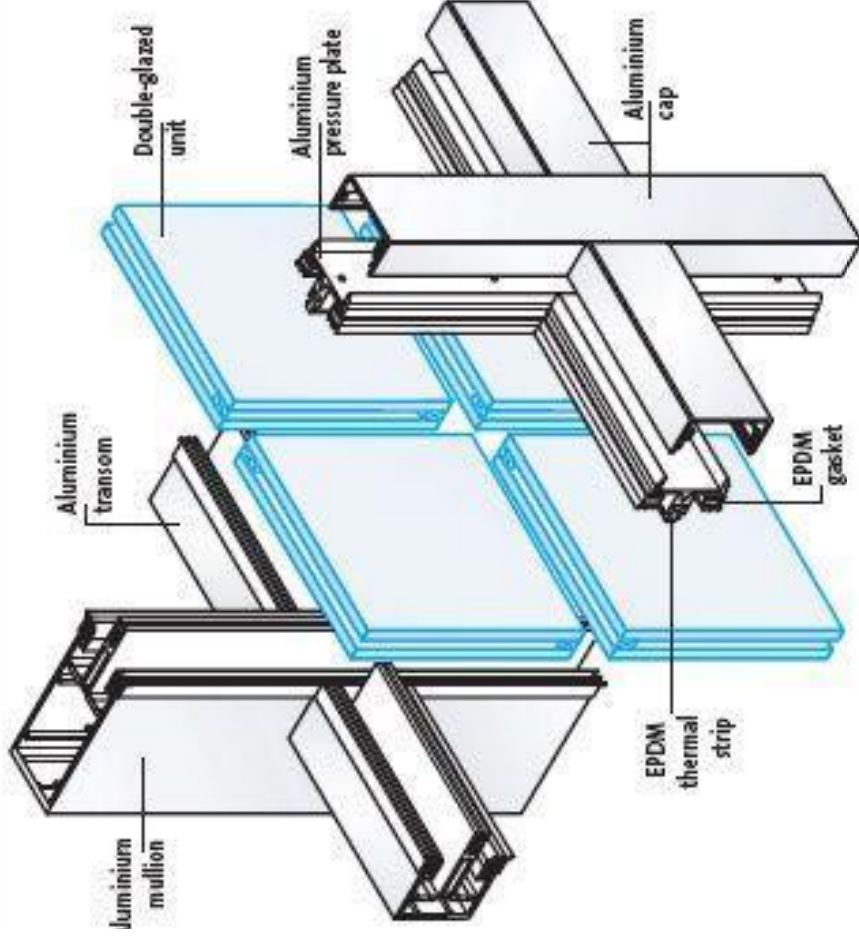

1. Less expensive comparing Unitized curtain wall
2. Fabricated materials are easy to be delivered to the site
3. To install, long pieces of vertical and horizontal aluminum are inserted between floors
4. Glazing is done on the site

# Photos



# SKETCHES

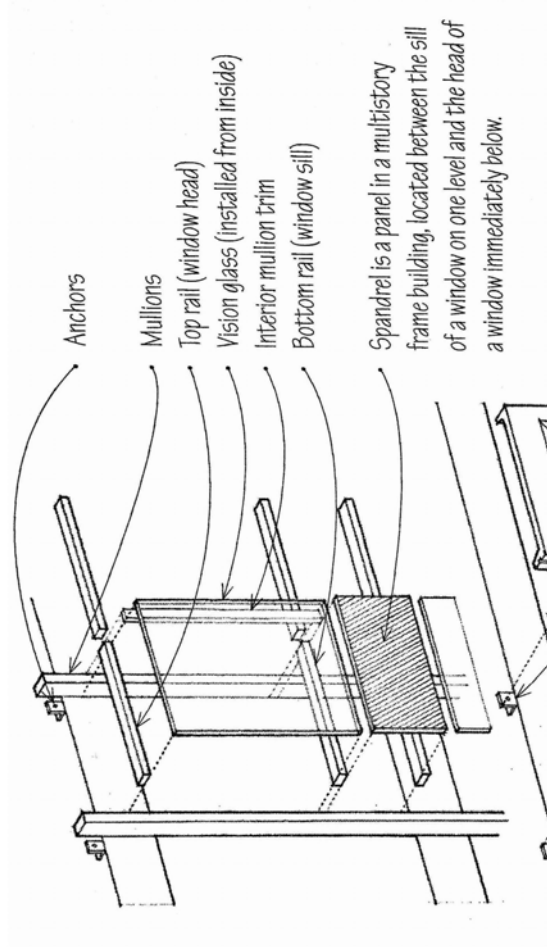

Spandrel is a panel in a multistory frame building, located between the sill of a window on one level and the head of a window immediately below.

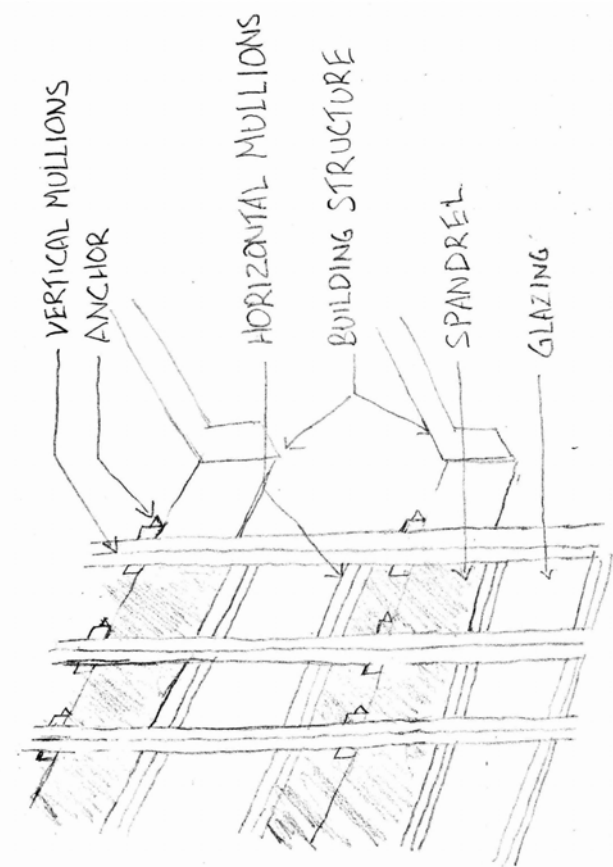

CHING BOOK 8.31

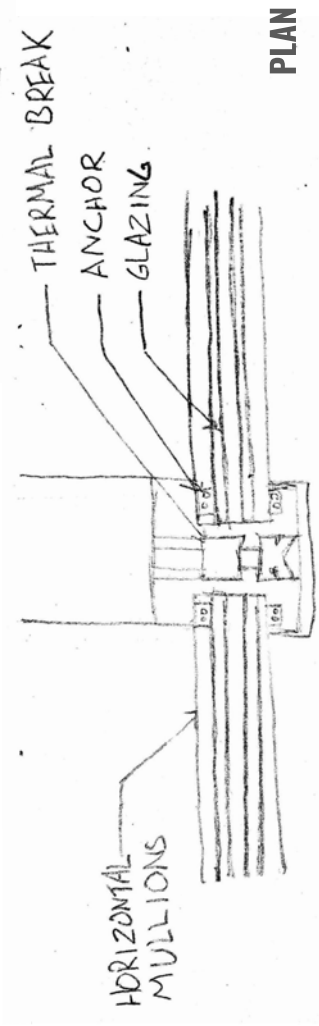

ISOMETRIC