



BTECH 3_GROUP DISLA

RENZO VALERIO, CHIMDIEBUBE EJIMBE, JEAN-
CARLOS PICHARDO, DELVIS DISLA



PROF. KING
SPRING 2016



STUDENT ARCH: JONATHAN RUBIO

HEALTH CLUB

Project Orientation

Zoning

Structure

MEP (Mechanical
Electrical)

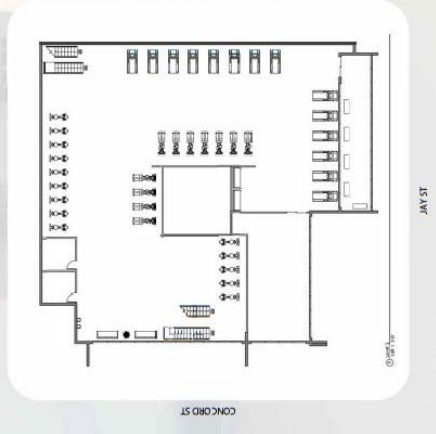
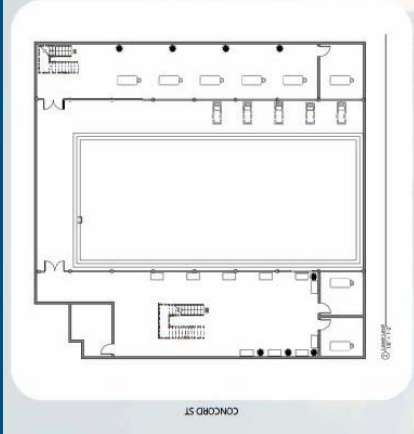
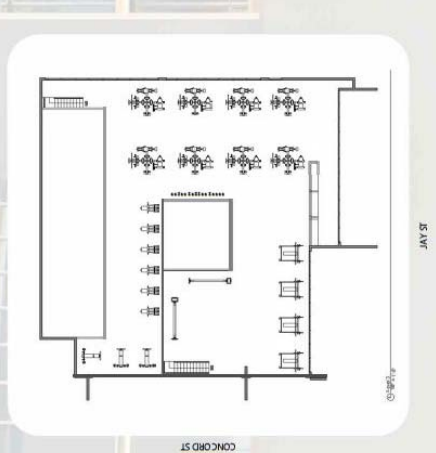
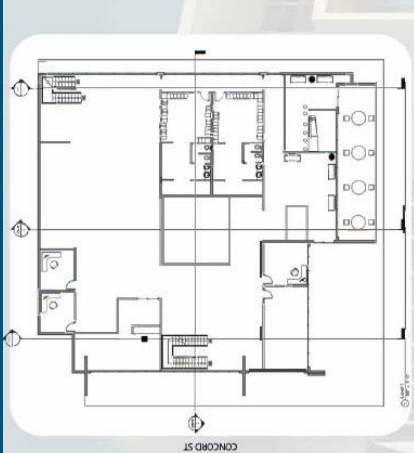

Project Orientation

Zoning

Structure

MEP (Mechanical
Electrical)

ORIGINAL SITE



Location: 219 Jay St. Brooklyn NY

Block 118 Lot 1

Primary Zoning: C6-2

- Building Footprints exceeded Lot Size
- Variance was granted by prof. King to relocate site

NEW SITE



Location: 203 Jay St. Brooklyn NY

Block 118 Lot 1

Primary Zoning: C6-2

Project Orientation

Zoning

Structure

MEP (Mechanical
Electrical)

Roofing materials unidentified

Horizontal mullion support unidentified

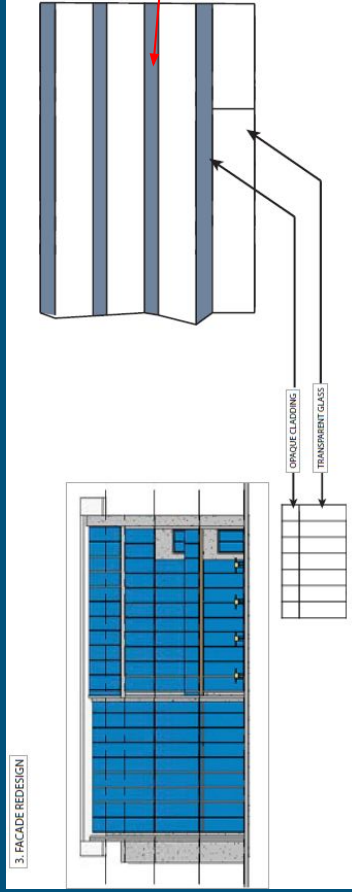

EXTERIOR RENDERINGS



Project Orientation

Zoning

Structure

**MEP (Mechanical
Electrical)**

- 1. Pool size doesn't work
- 2. Spa rooms not arranged properly
- 3. Dry and wet circulation cross path
- 4. No structural support

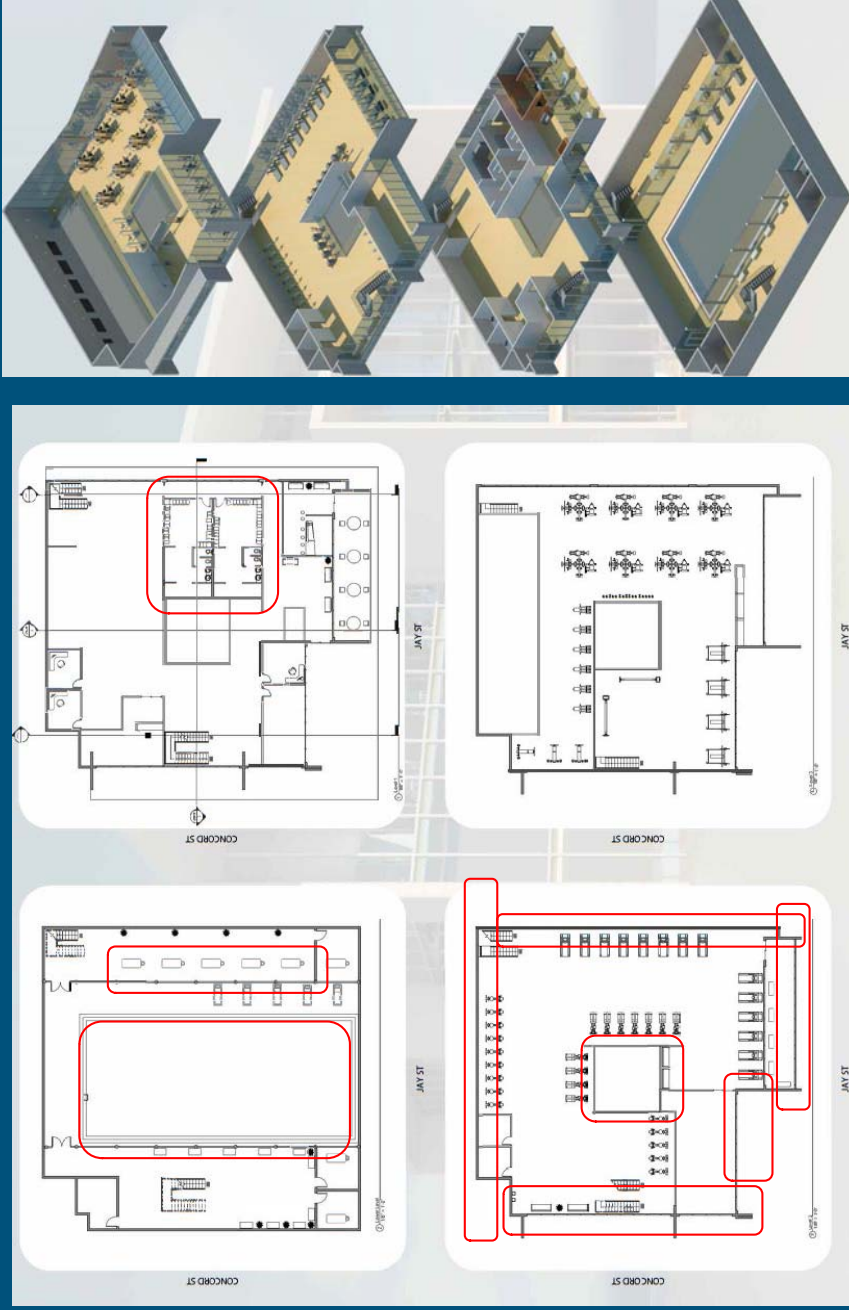

EXISTING FLOOR PLANS

Project Orientation

Zoning

Structure

MEP (Mechanical
Electrical)

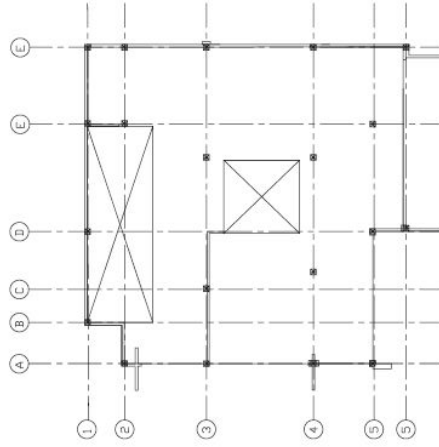
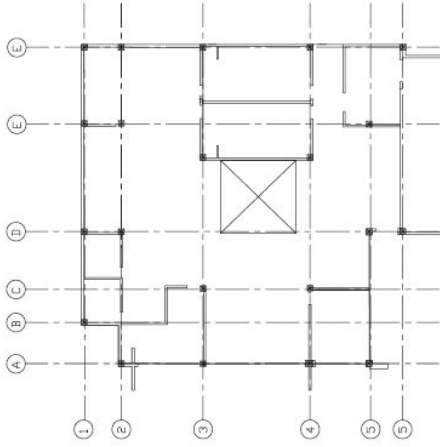
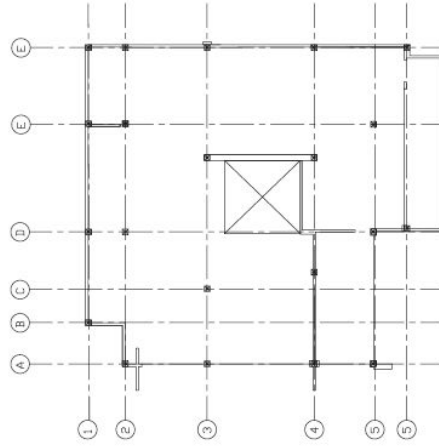
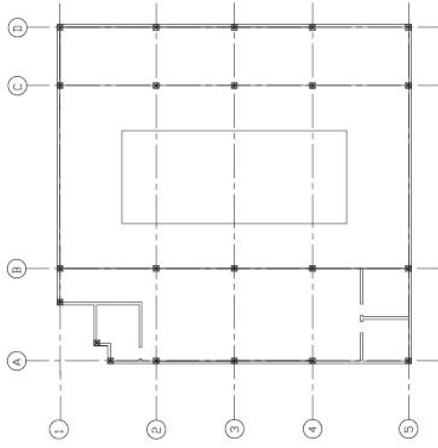

Project Orientation

Zoning

Structure

MEP (Mechanical
Electrical)

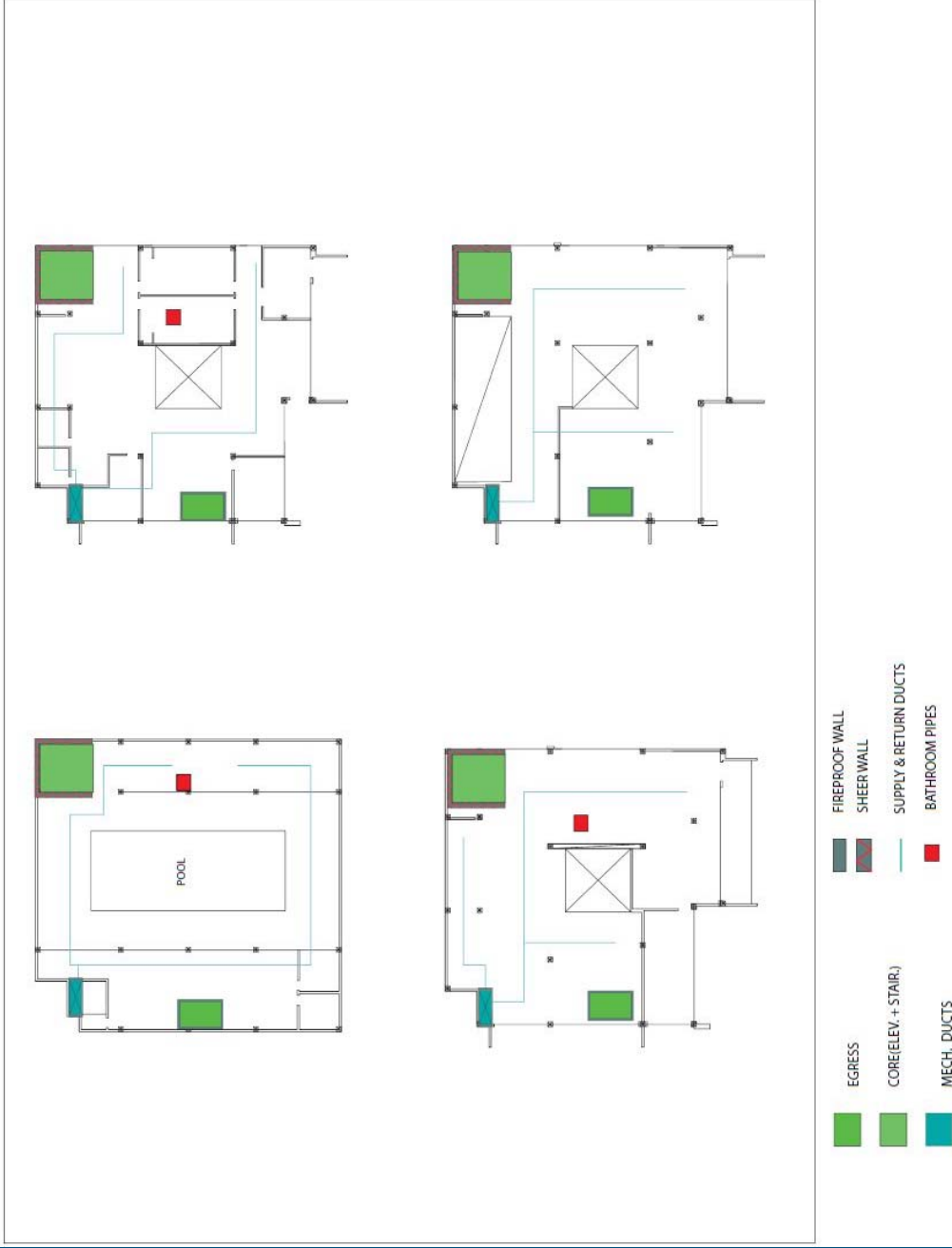

Project Orientation

Zoning

Structure

MEP (Mechanical
Electrical)

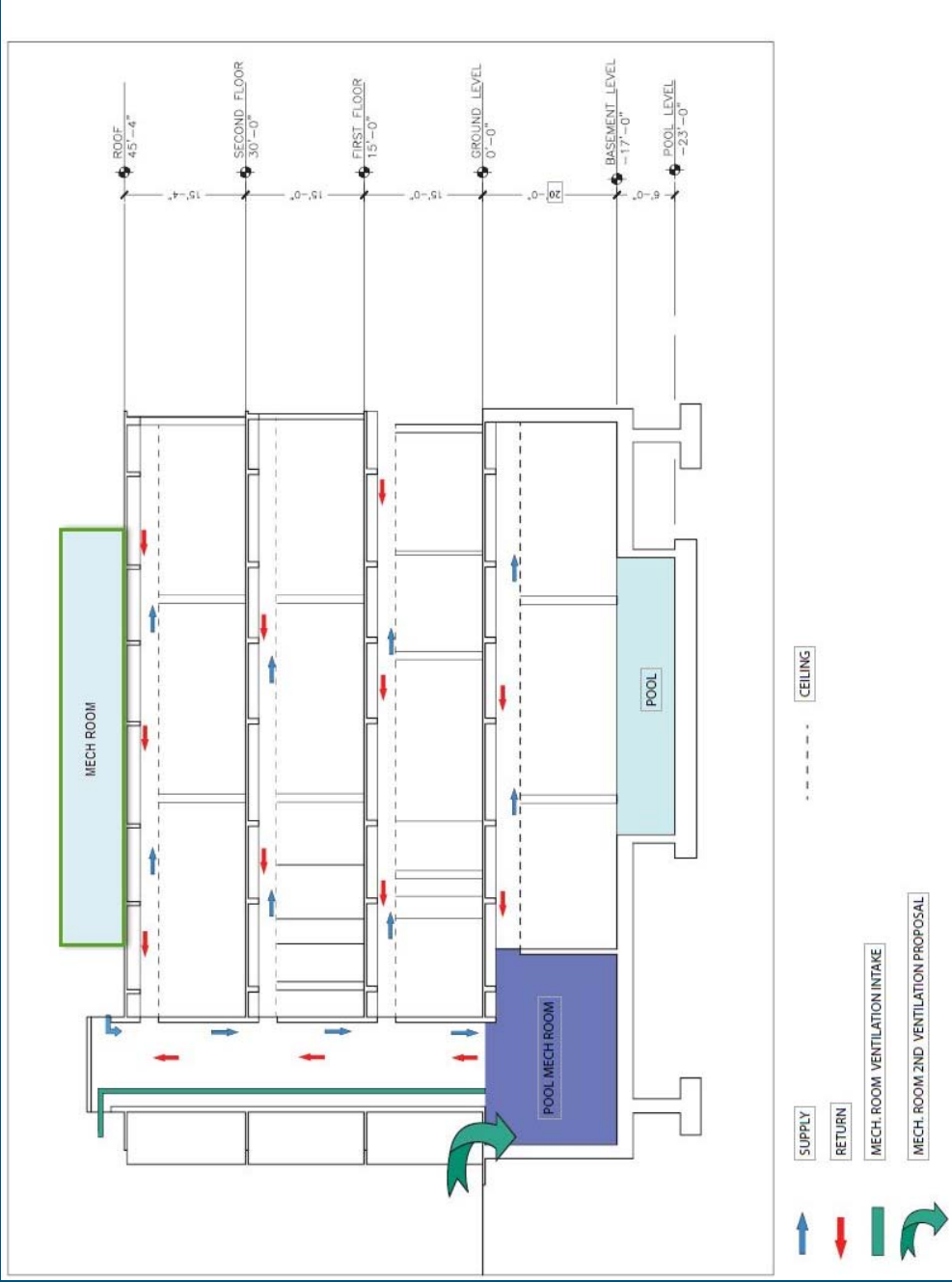

Project Orientation

Zoning

Structure

MEP (Mechanical
Electrical)

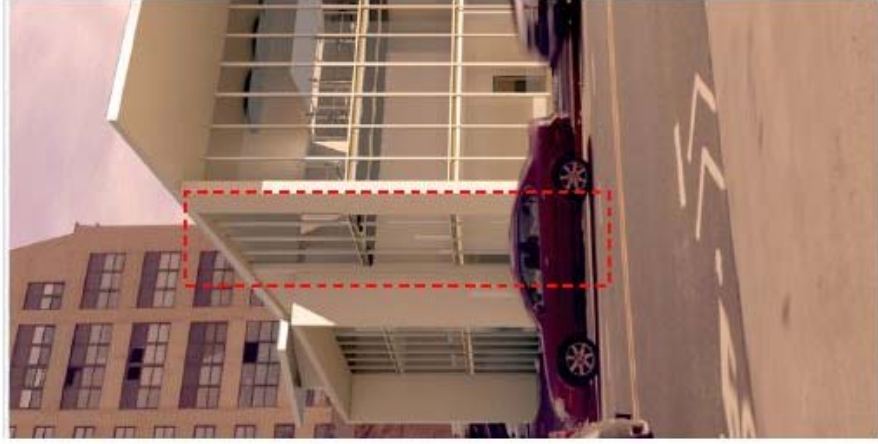
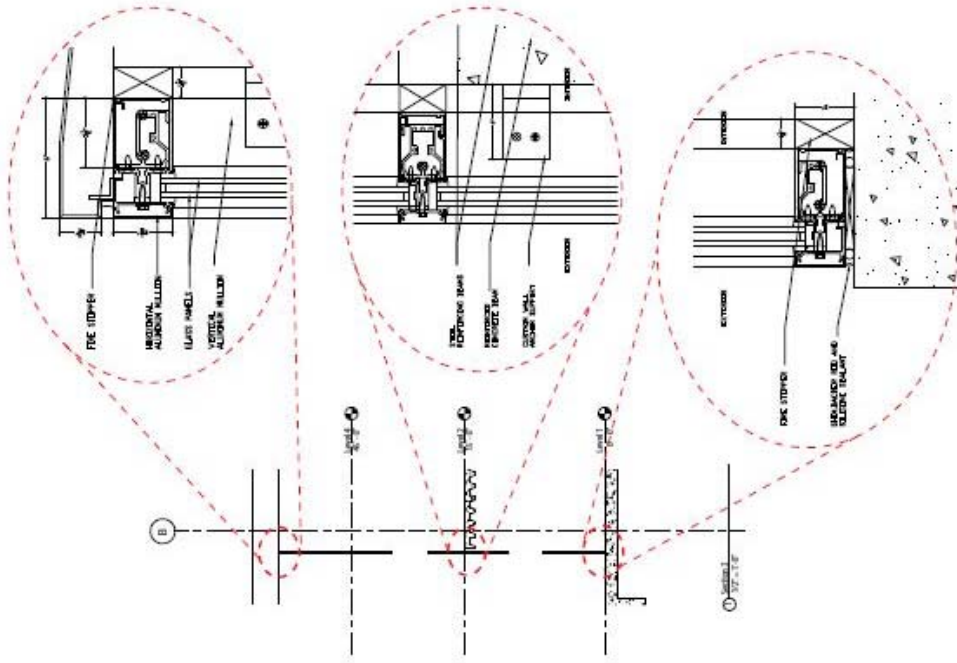

CHIMDIEBUBE EJIMBE



Structural Framing

Floor plans

RCP

Elevation & sections

Partitions, Wall Section
& Plan Details

Research

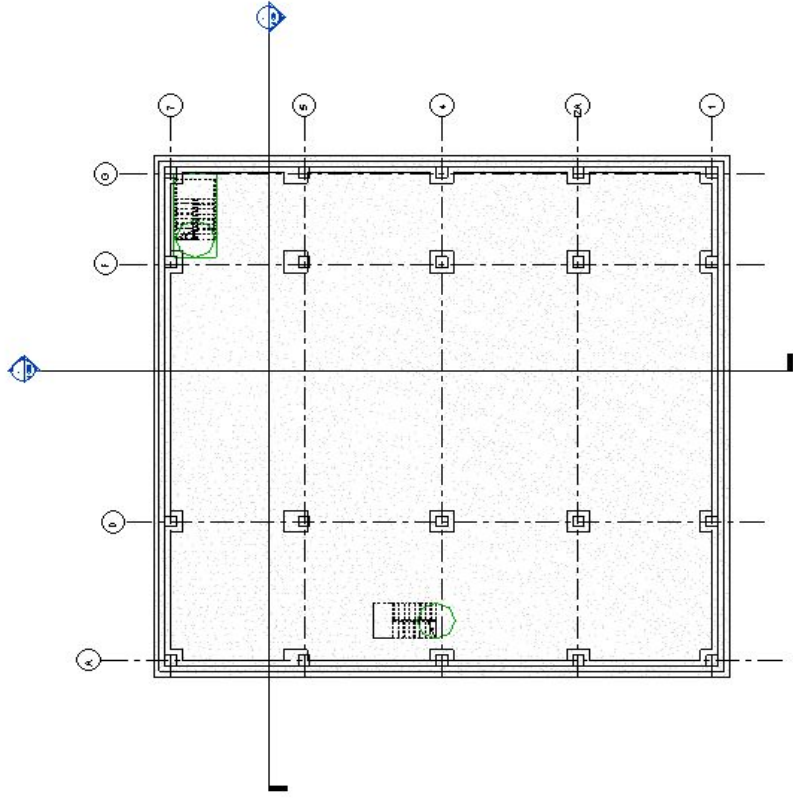

BASEMENT

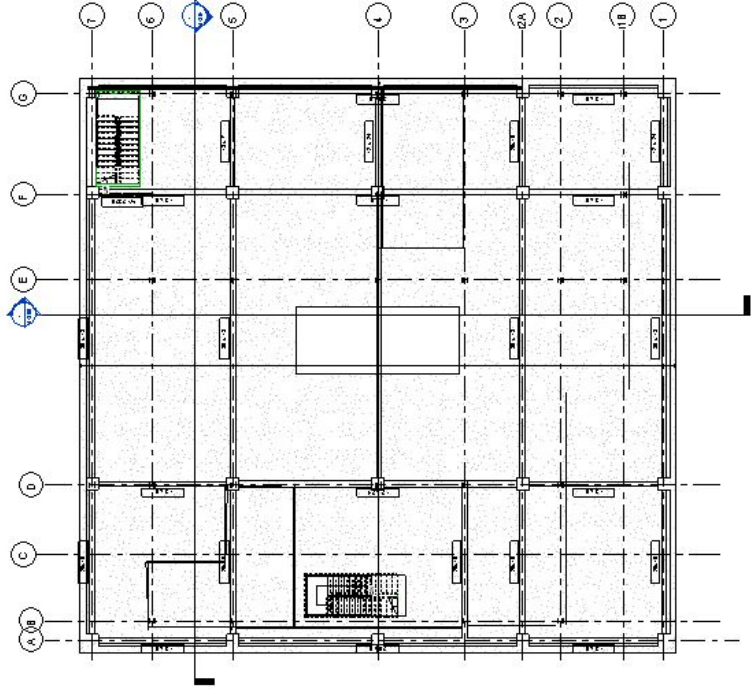

FIRST FLOOR

Structural Framing

Floor plans

RCP

Elevation & sections

Partitions, Wall Section
& Plan Details

Research

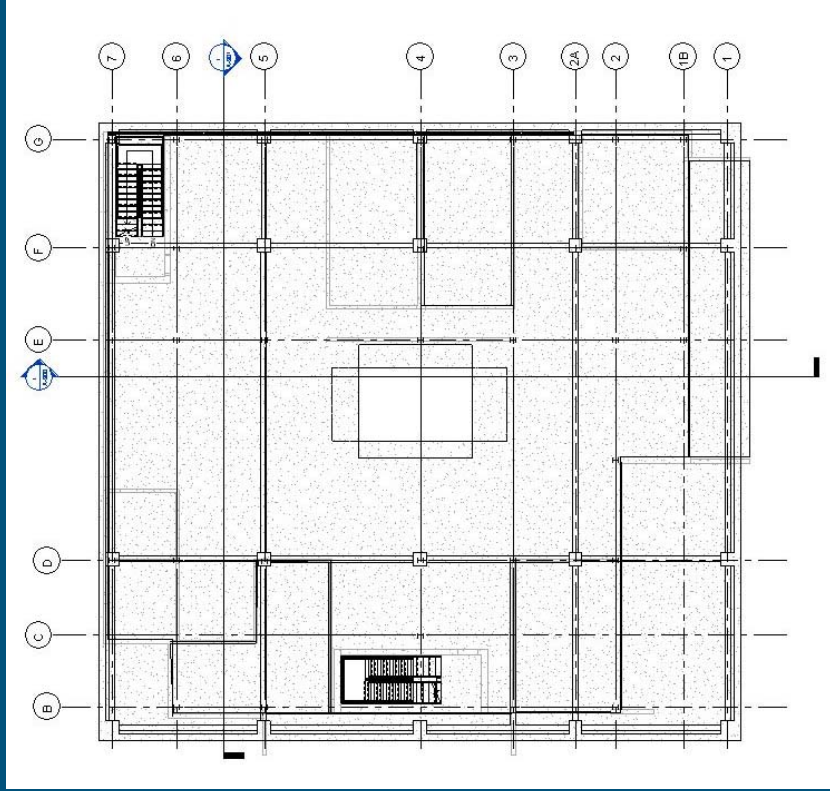

SECOND FLOOR

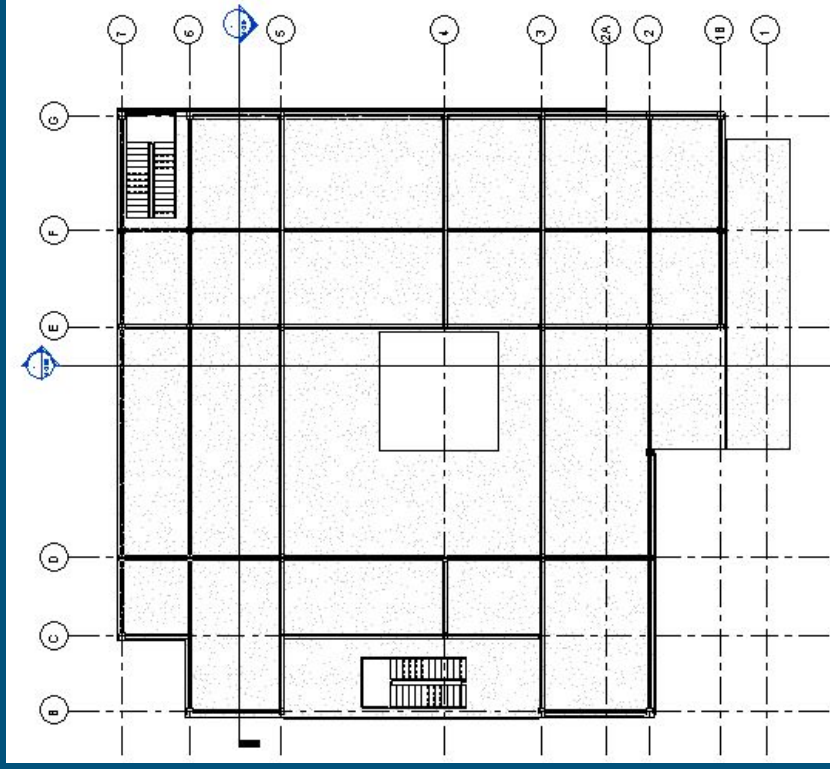

THIRD FLOOR

Structural Framing

Floor plans

RCP

Elevation & sections

Partitions, Wall Section
& Plan Details

Research

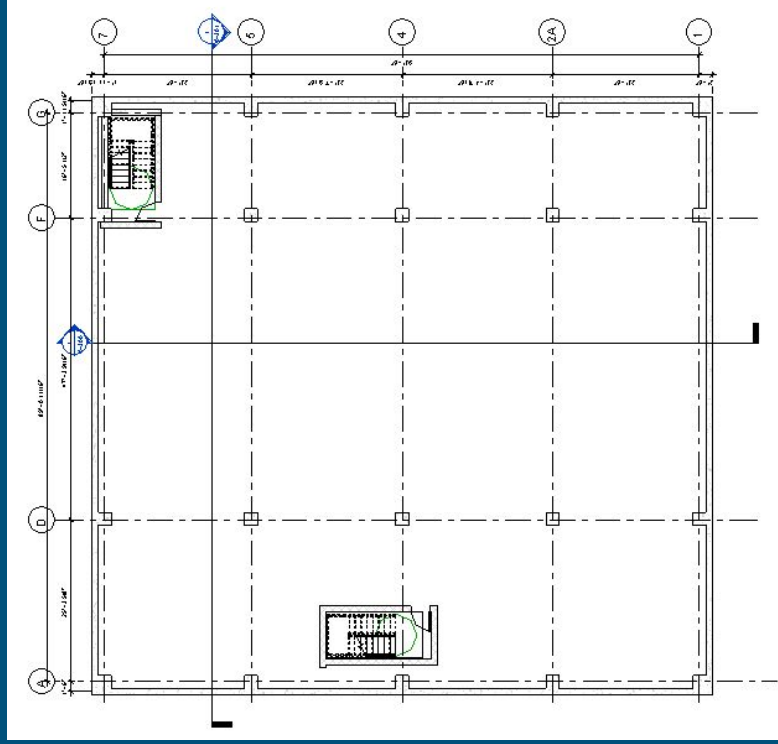

BASEMENT

FIRST FLOOR

Structural Framing

Floor plans

RCP

Elevation & sections

Partitions, Wall Section
& Plan Details

Research

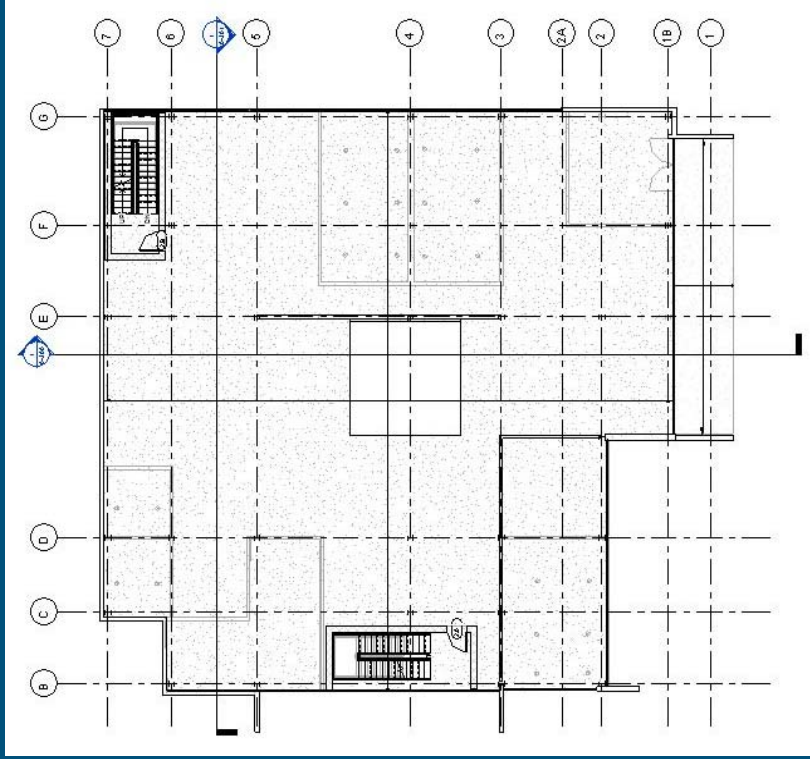

SECOND FLOOR

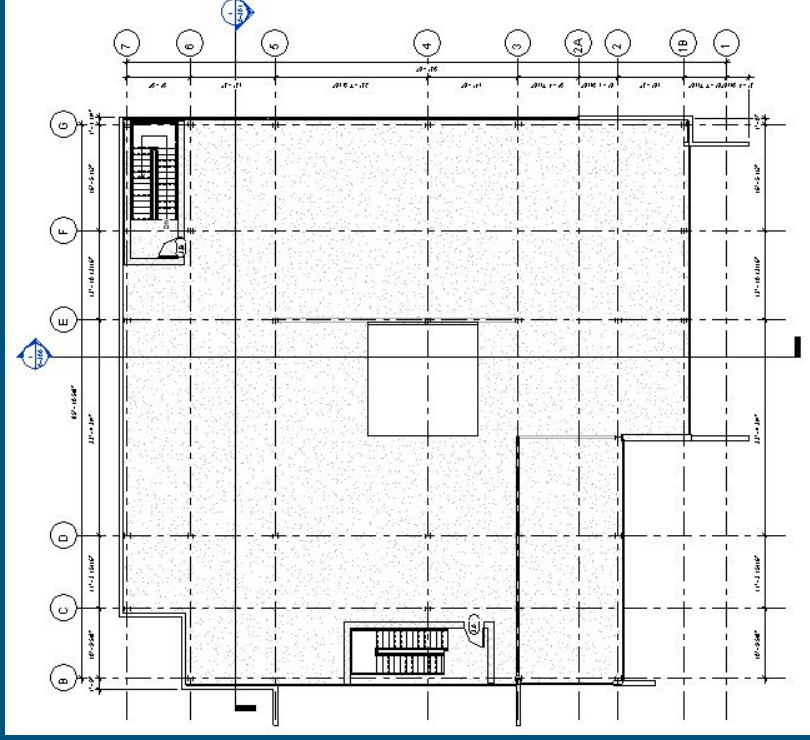

THIRD FLOOR

Structural Framing

Floor plans

RCP

Elevation & sections

Partitions, Wall Section & Plan Details

Research

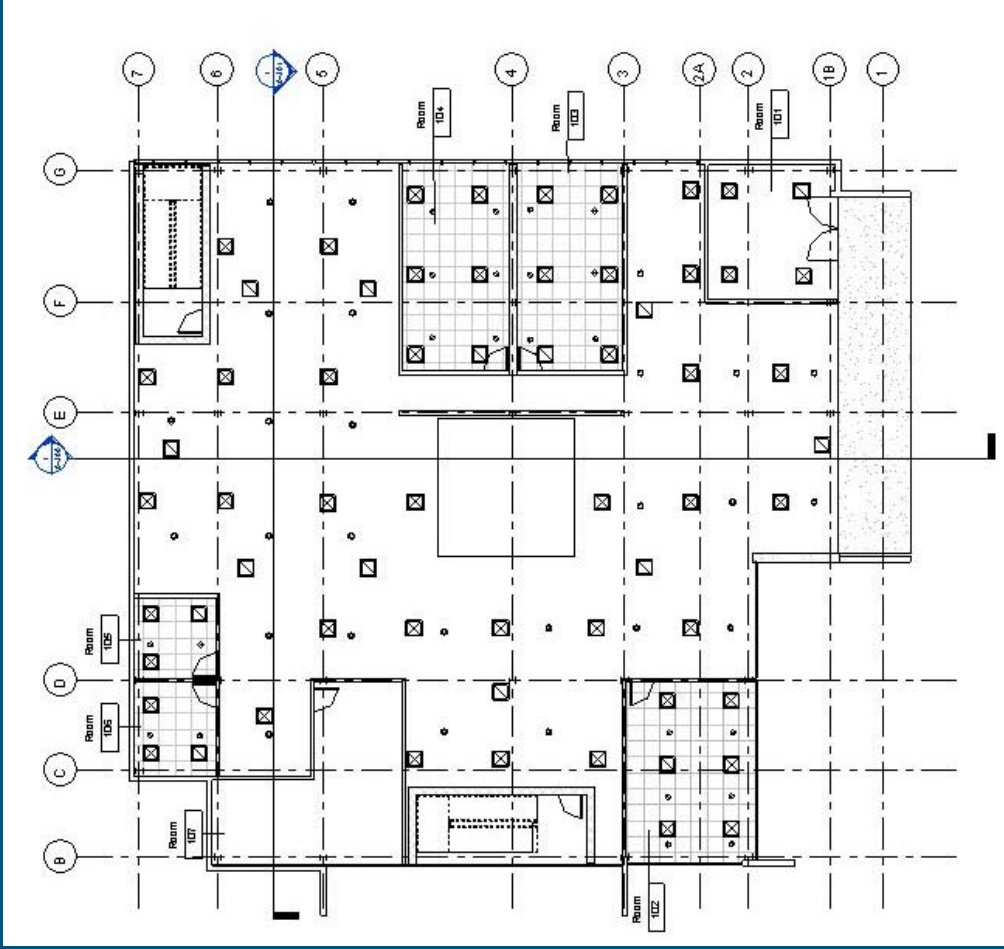

Structural Framing

Floor plans

RCP

Elevation & sections

Partitions, Wall Section & Plan Details

Research

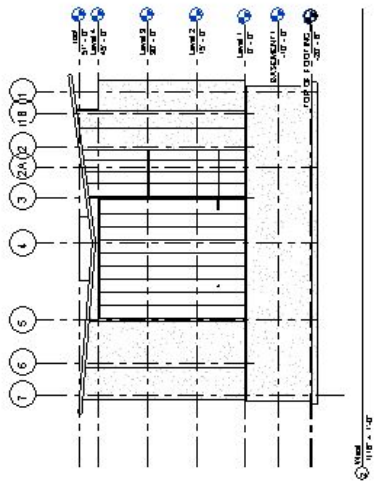
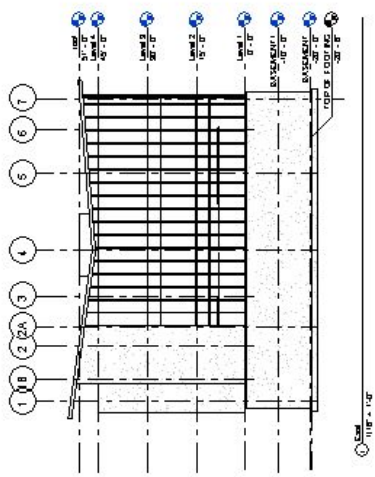
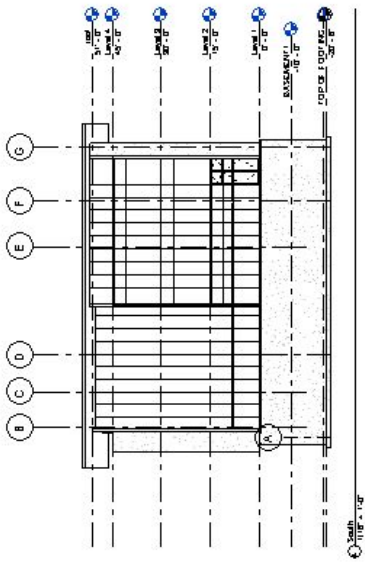
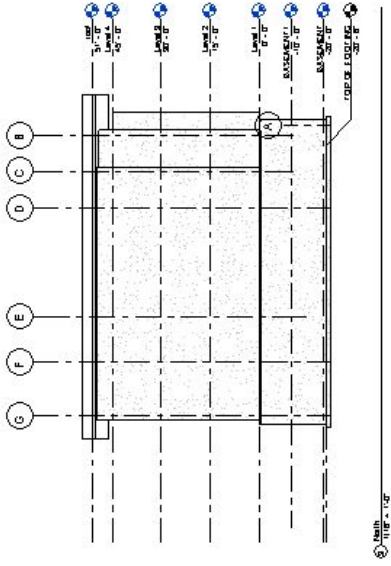

Structural Framing

Floor plans

RCP

Elevation & sections

Partitions, Wall Section & Plan Details

Research

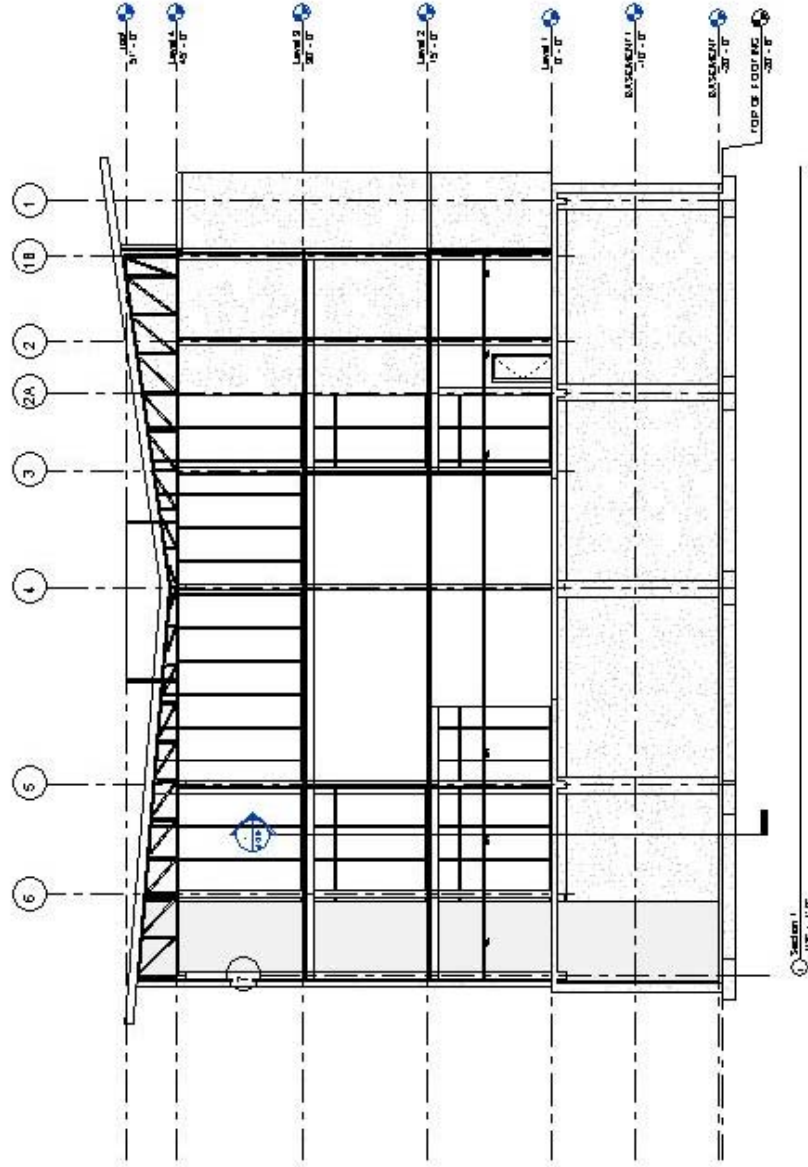

Structural Framing

Floor plans

RCP

Elevation & sections

Partitions, Wall Section
& Plan Details

Research

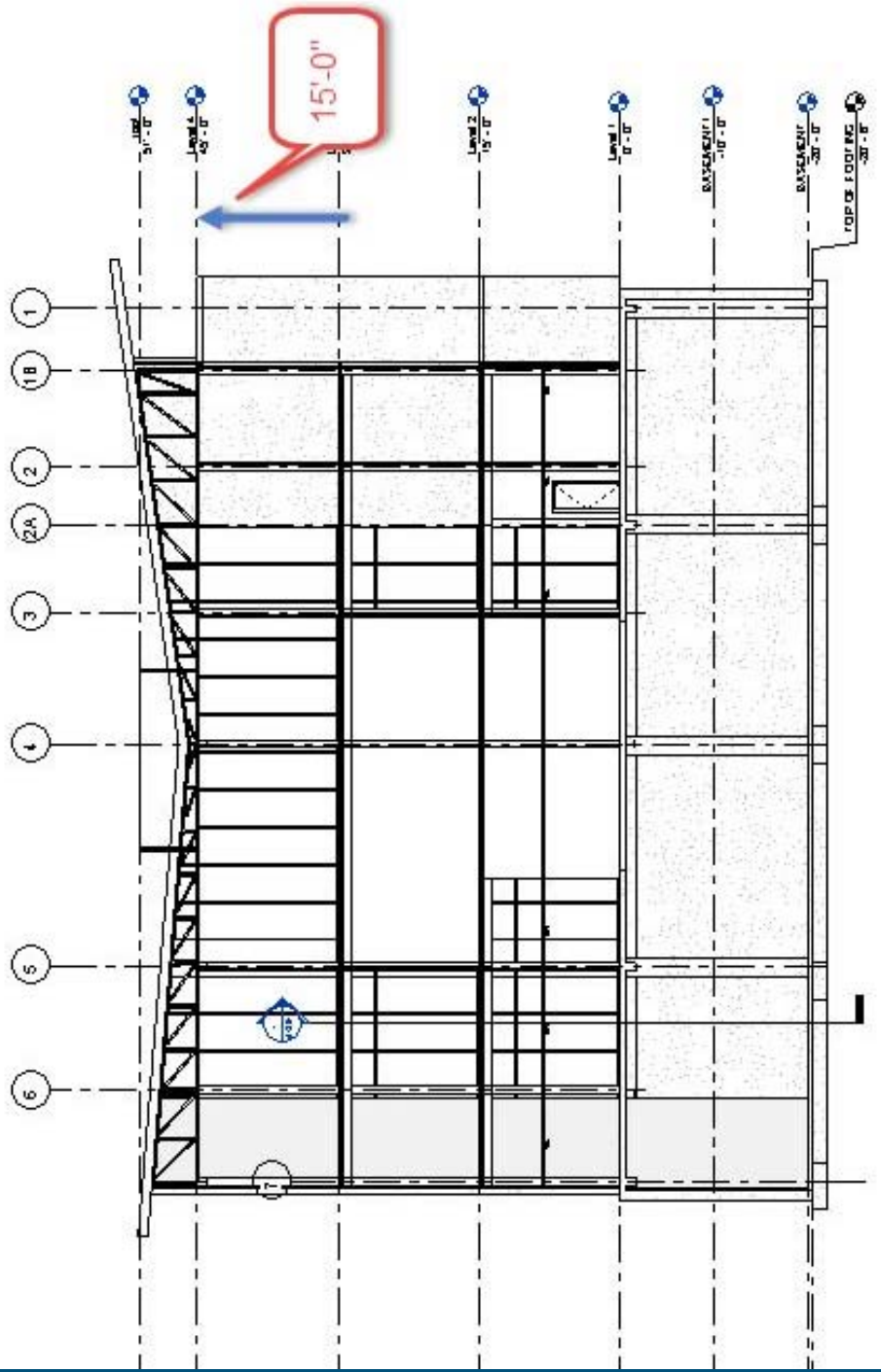

Structural Framing

Floor plans

RCF

Elevation & sections

Partitions, Wall Section
& Plan Details

Research

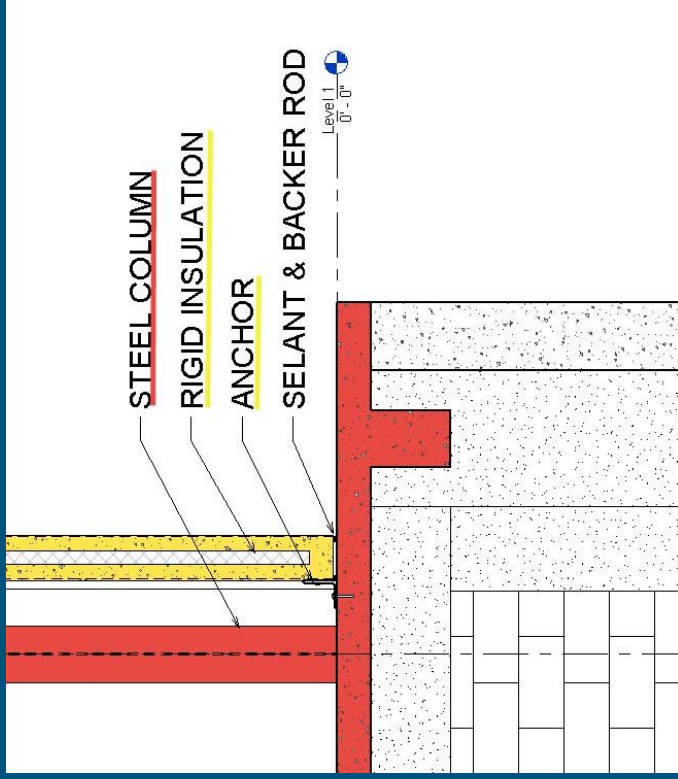

Structural Framing

Floor plans

RCF

Elevation & sections

Partitions, Wall Section
& Plan Details

Research

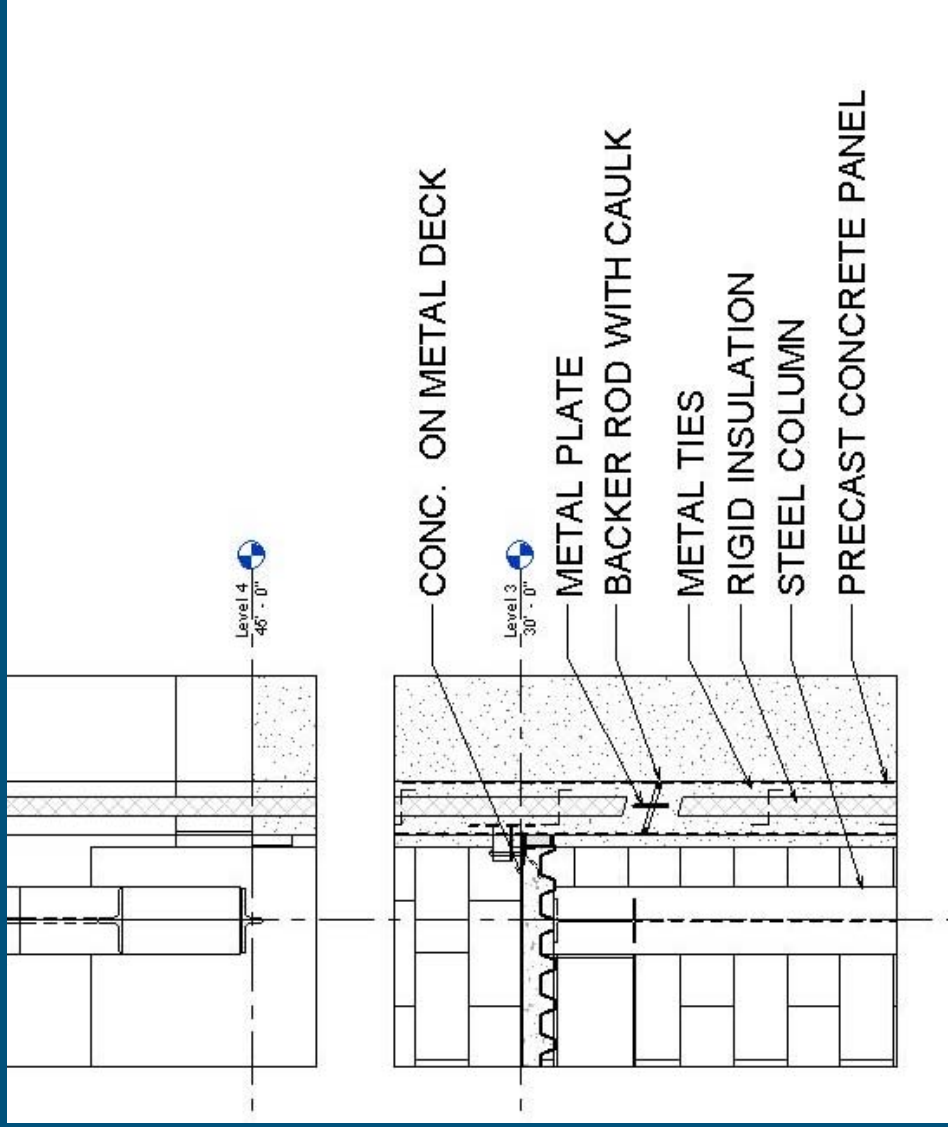

Structural Framing

Floor plans

RCF

Elevation & sections

Partitions, Wall Section
& Plan Details

Research

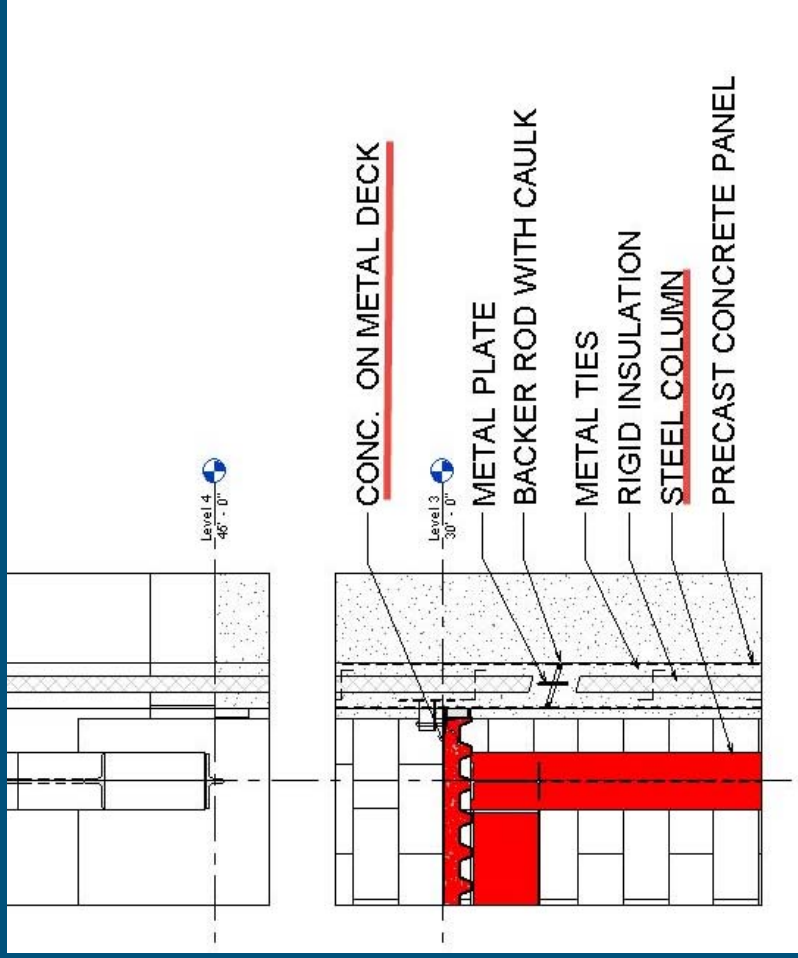

Structural Framing

Floor plans

RCF

Elevation & sections

Partitions, Wall Section
& Plan Details

Research

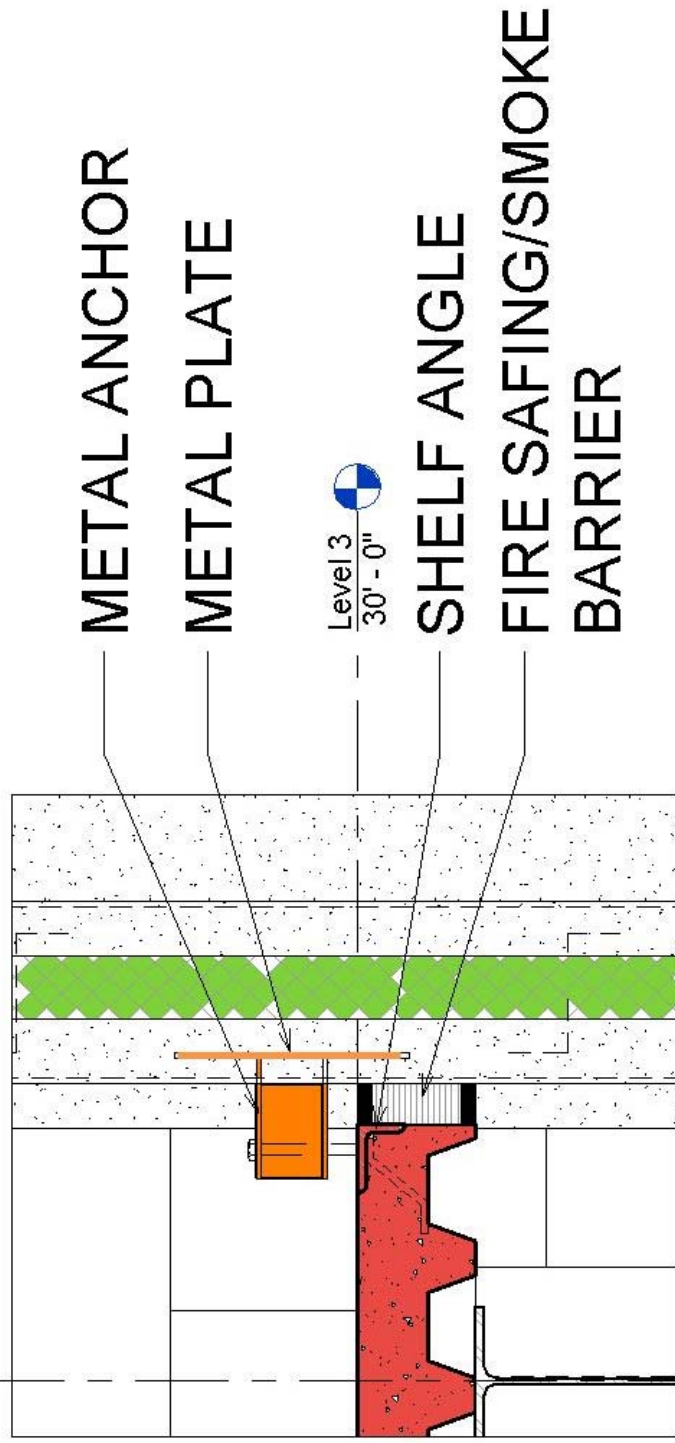

Structural Framing

Floor plans

RCF

Elevation & sections

Partitions, Wall Section
& Plan Details

Research

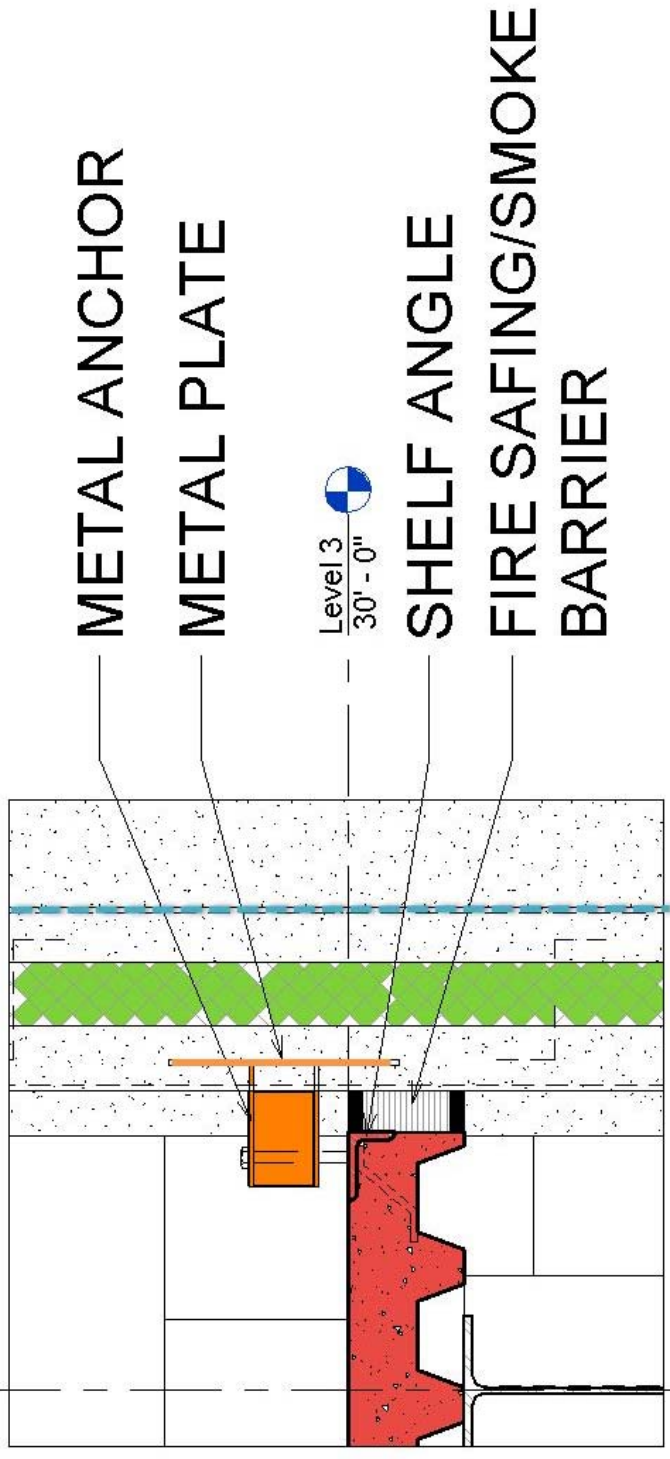

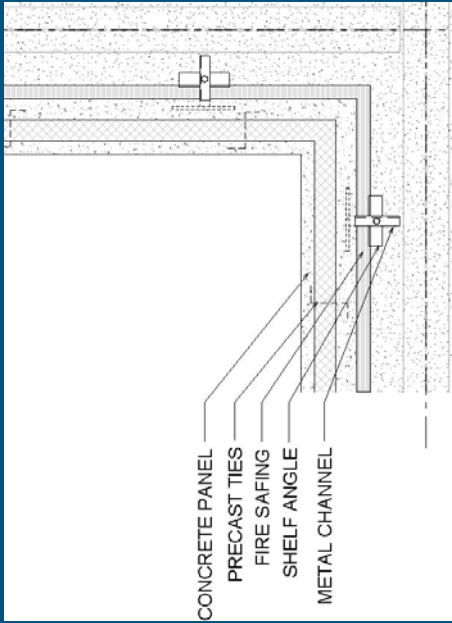
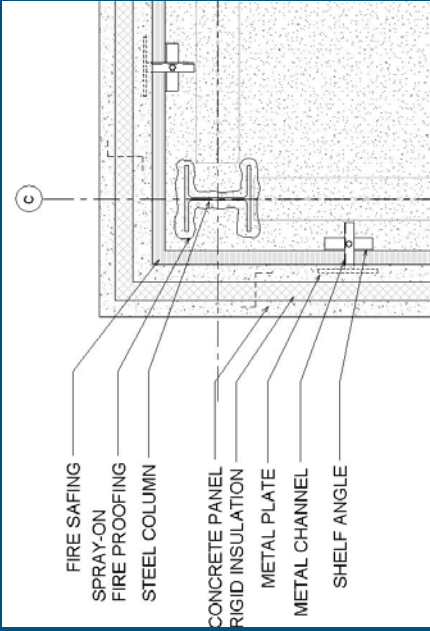
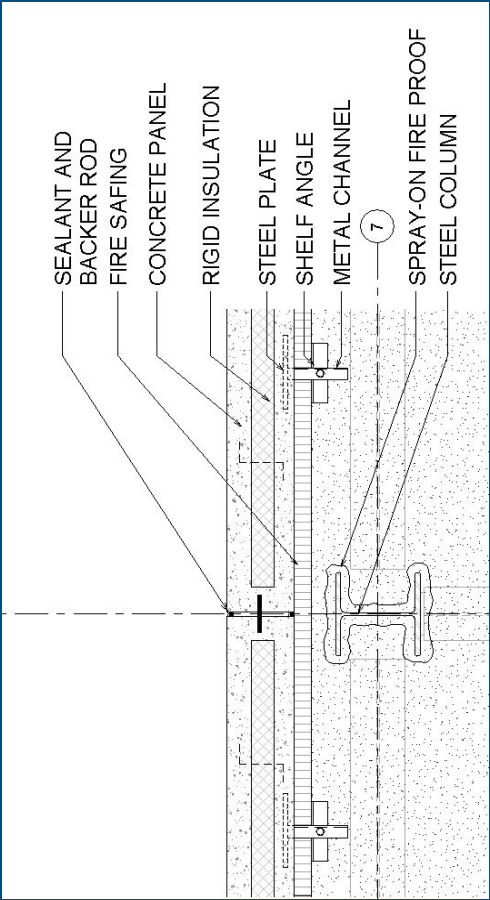

Structural Framing

Floor plans

RCF

Elevation & sections

Partitions, Wall Section
& Plan Details

Research

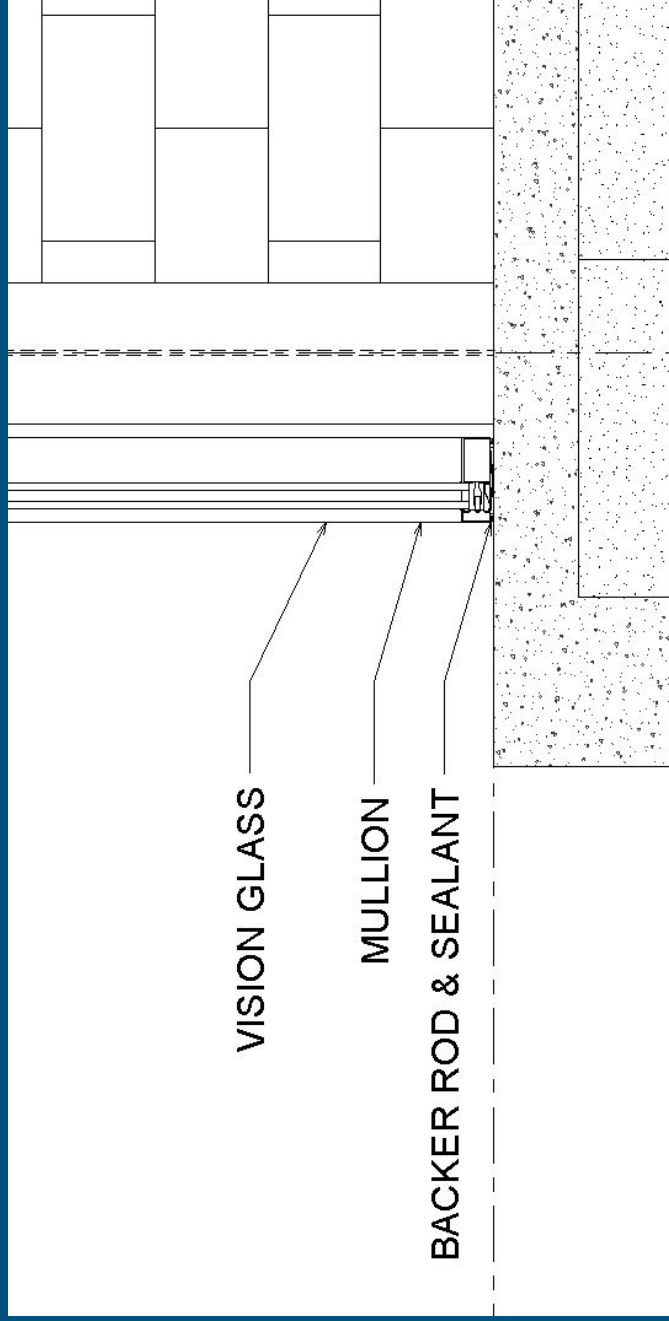

Structural Framing

Floor plans

RCF

Elevation & sections

Partitions, Wall Section
& Plan Details

Research

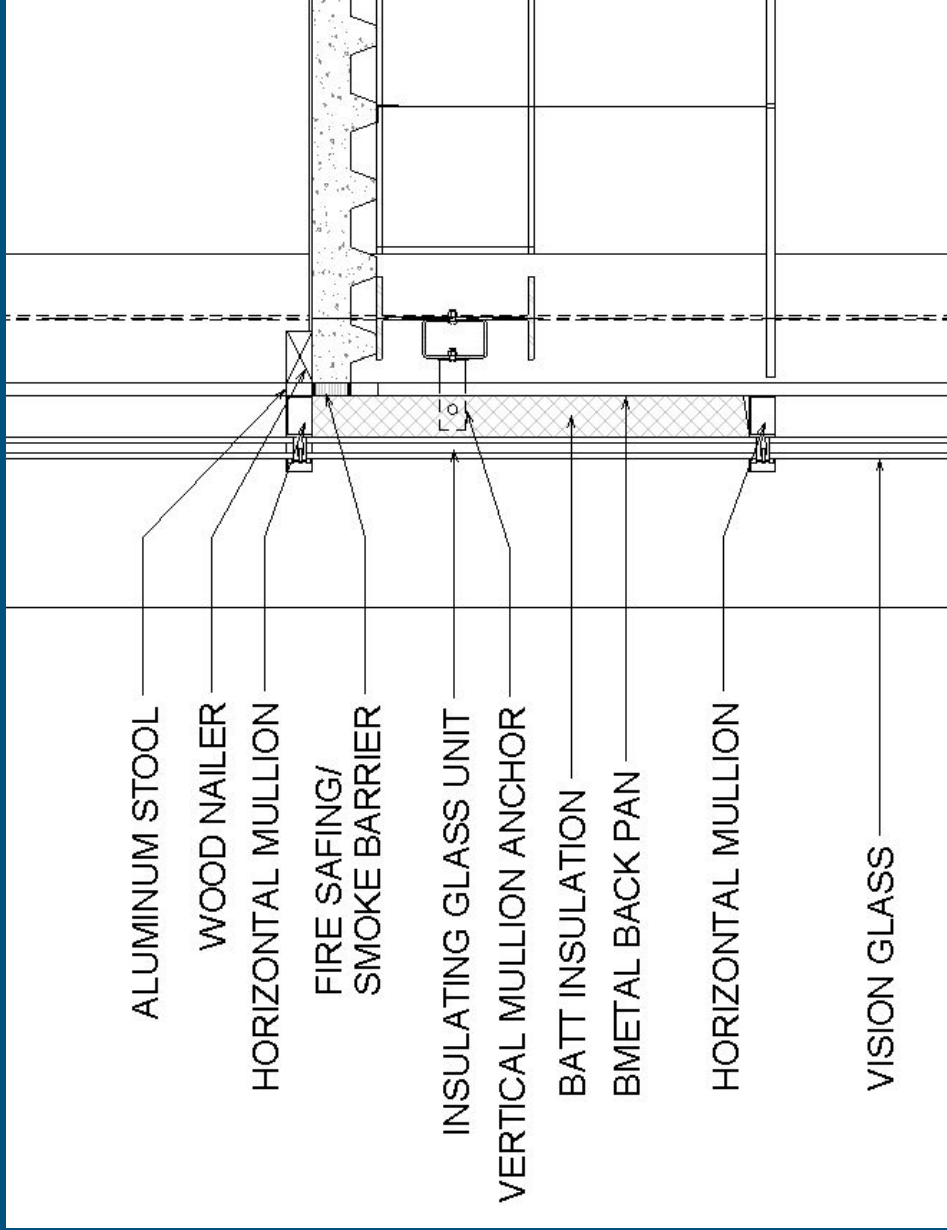

Structural Framing

Floor plans

RCF

Elevation & sections

Partitions, Wall Section & Plan Details

Research

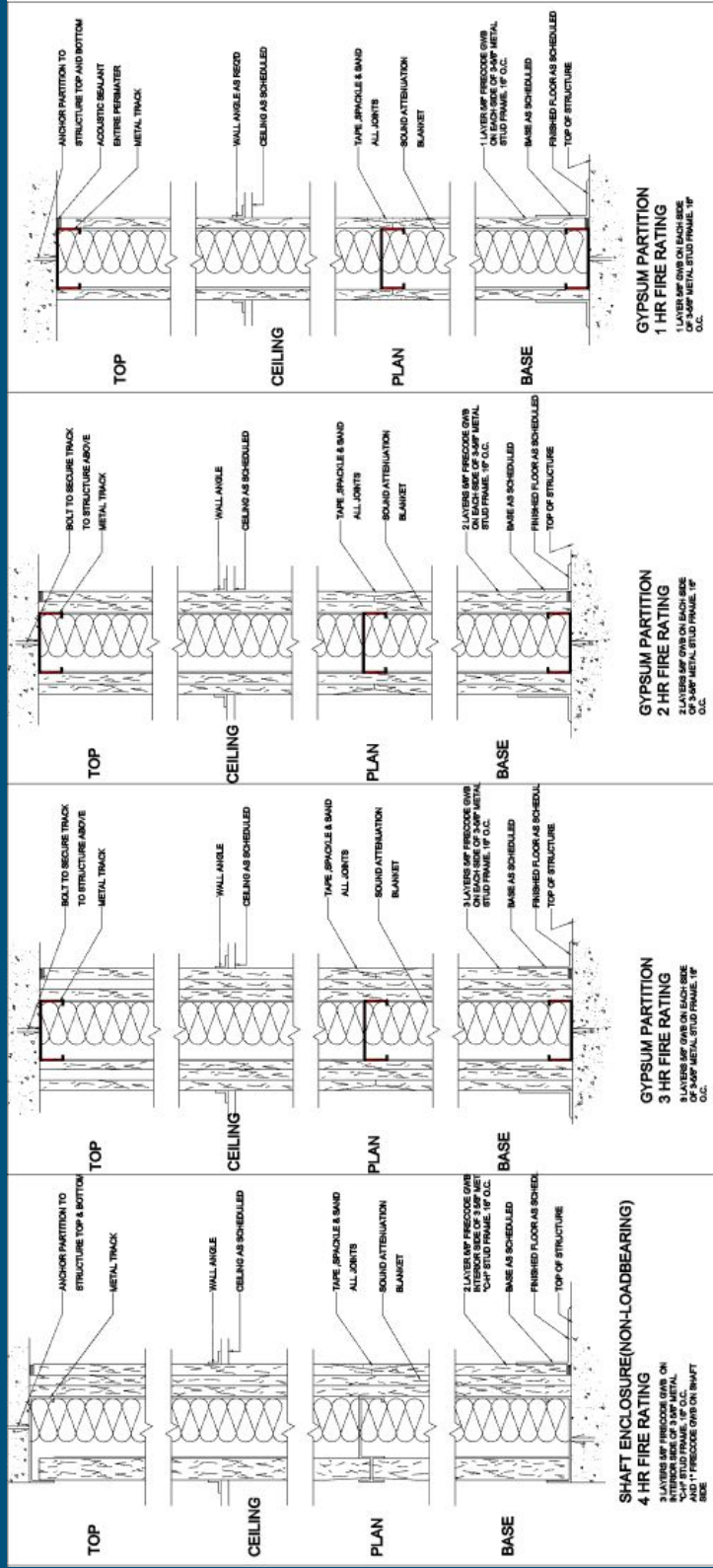

Structural Framing

Floor plans

RCF

Elevation & sections

Partitions, Wall Section & Plan Details

Research

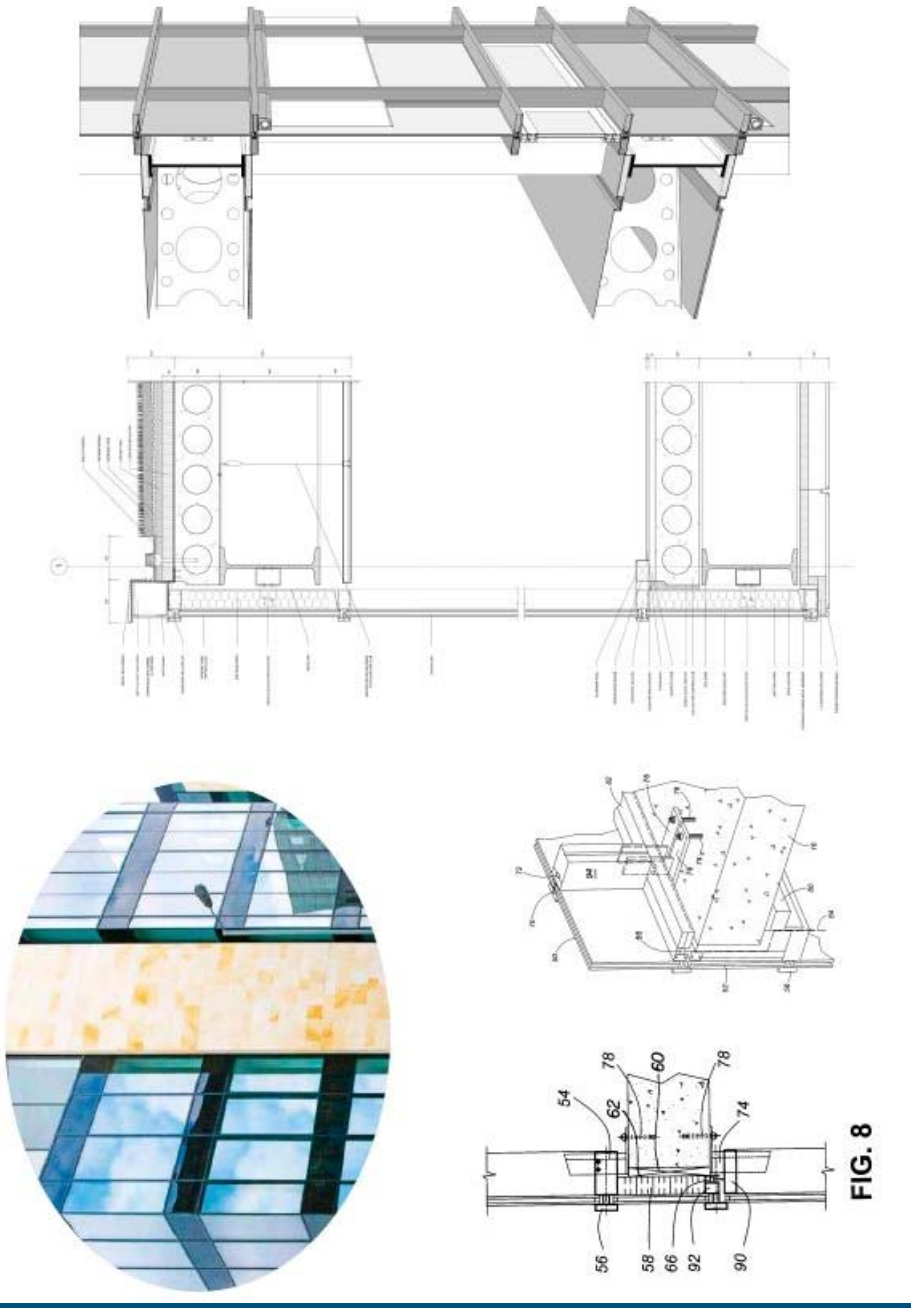

FIG. 8

Jean Carlos Pichardo



Structural Framing

Floor plans

RCF

Elevation & sections

Partitions, Wall Section
& Plan Details

Research

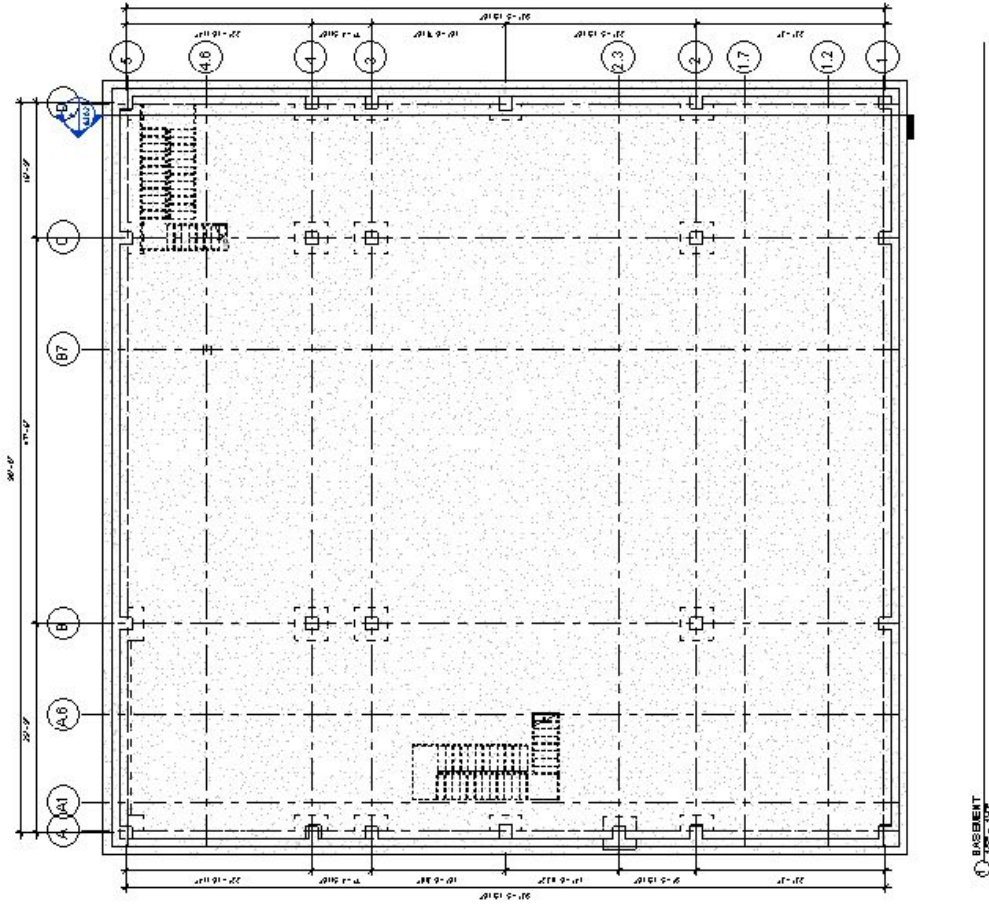

Basement
1/8" = 1'-0"

Structural Framing

Floor plans

RCF

Elevation & sections

Partitions, Wall Section & Plan Details

Research

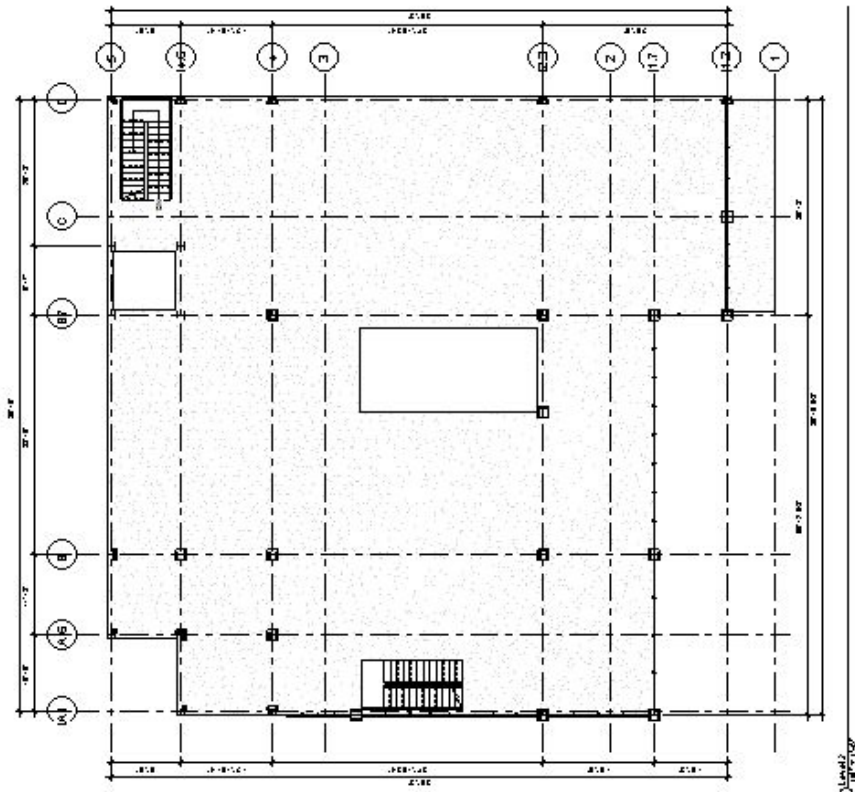
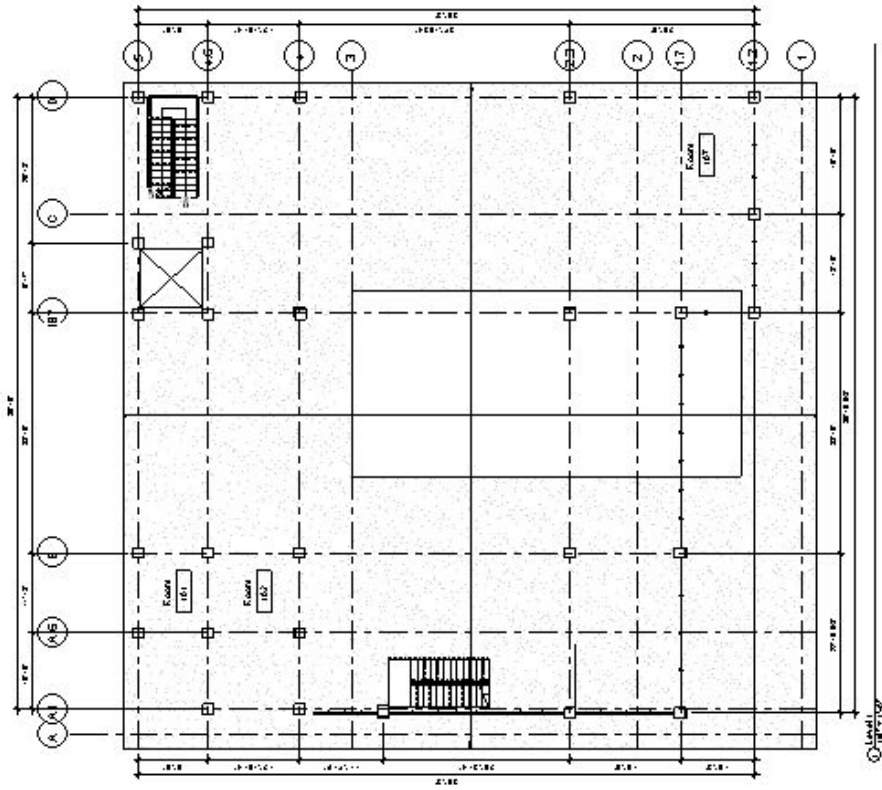

Structural Framing

Floor plans

RCF

Elevation & sections

Partitions, Wall Section
& Plan Details

Research

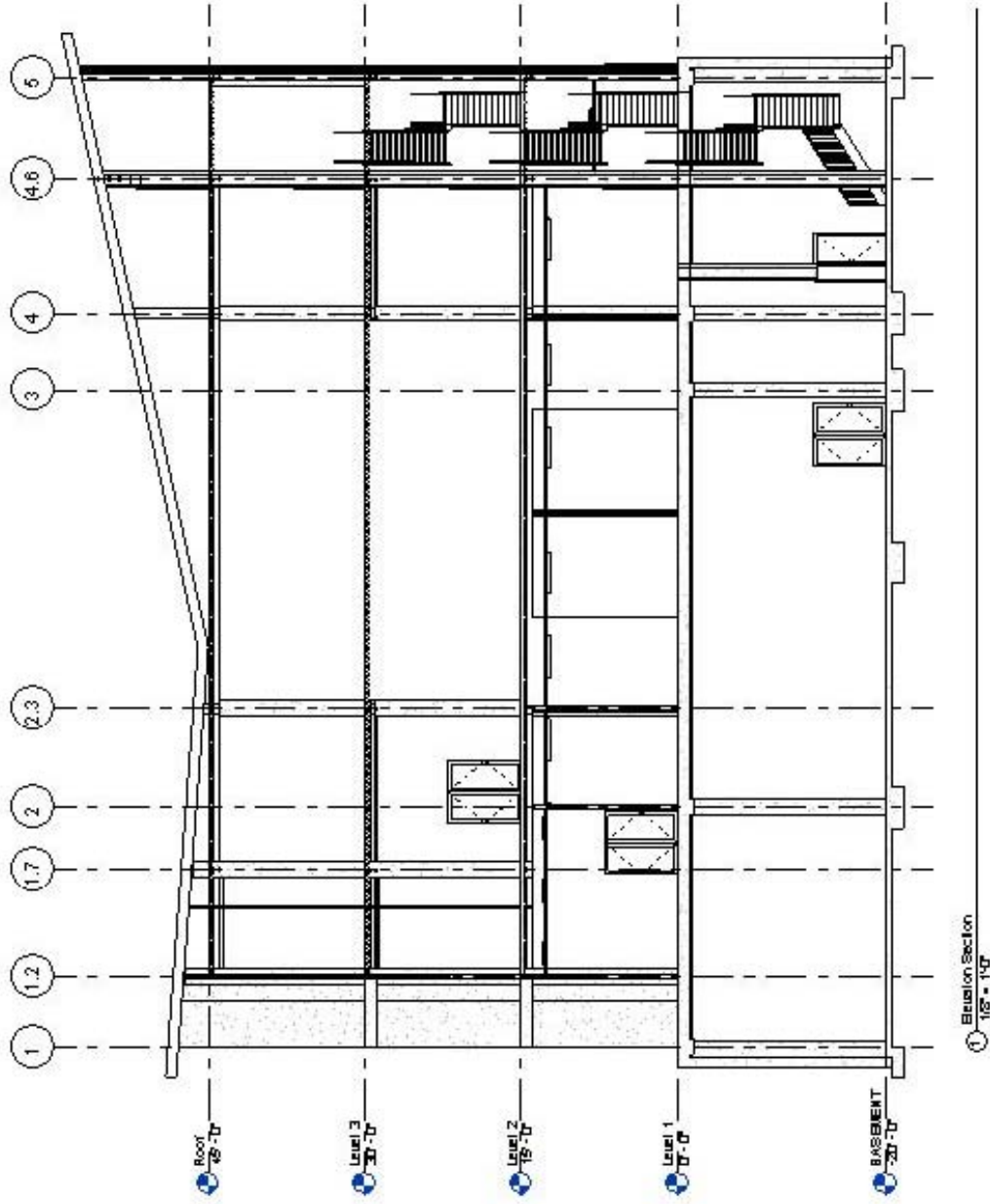

① Elevation Section
1/8" = 1'-0"

Structural Framing

Floor plans

RCF

Elevation & sections

Partitions, Wall Section
& Plan Details

Research

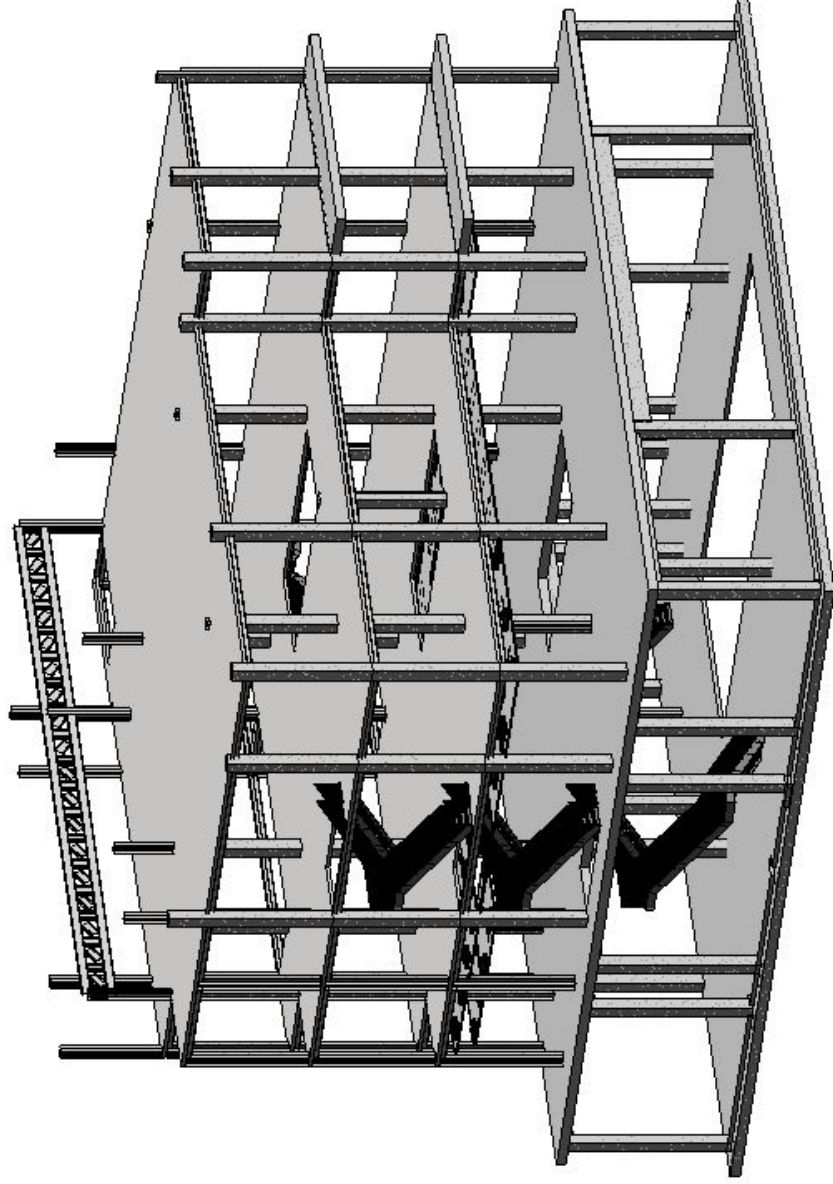

Structural Framing

Floor plans

RCF

Elevation & sections

Partitions, Wall Section
& Plan Details

Research

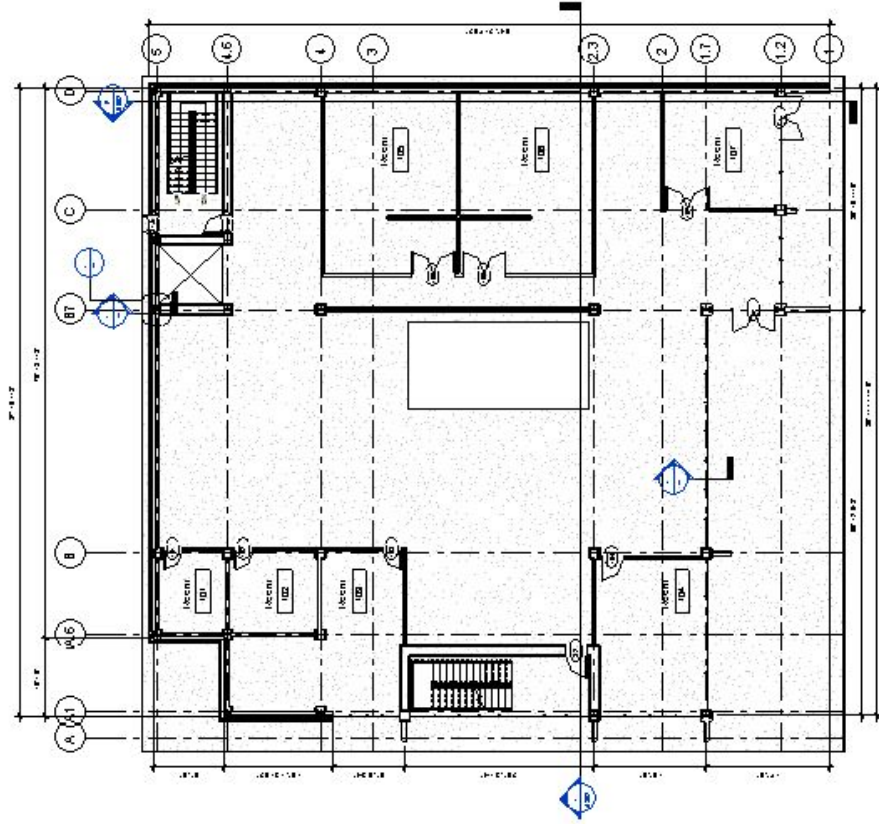

100' x 100'

100' x 100'

Structural Framing

Floor plans

RCF

Elevation & sections

Partitions, Wall Section & Plan Details

Research

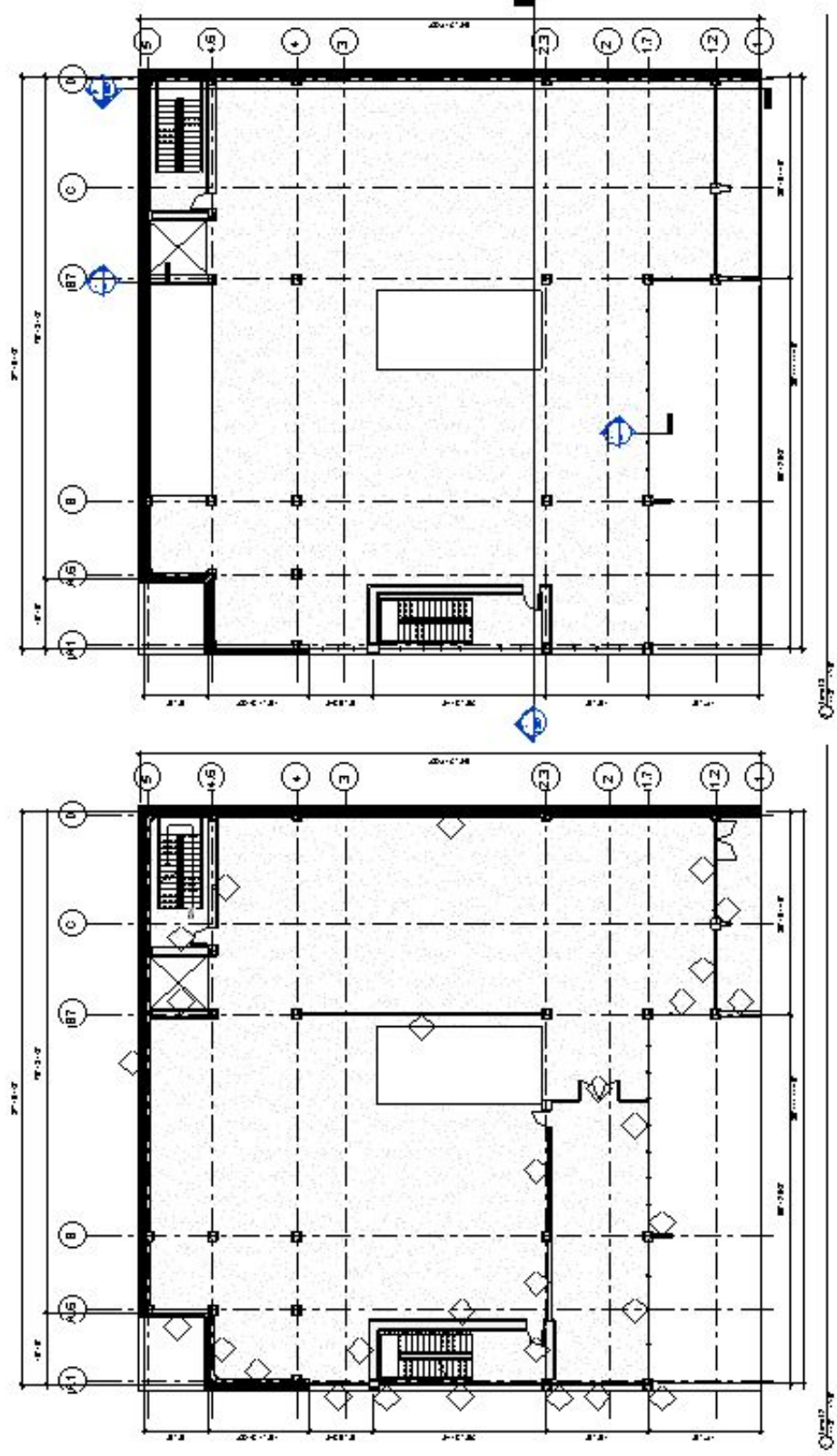

Structural Framing

Floor plans

RCF

Elevation & sections

Partitions, Wall Section & Plan Details

Research

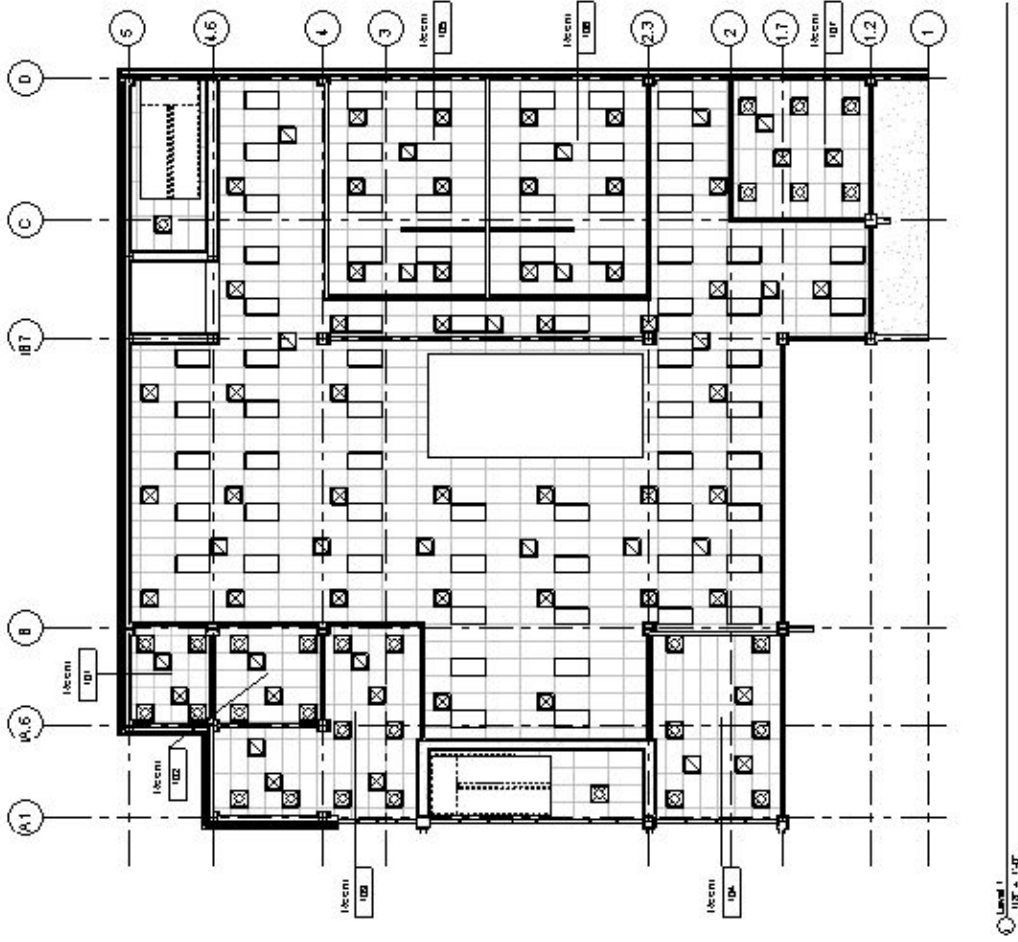

Structural Framing

Floor plans

RCF

Elevation & sections

Partitions, Wall Section & Plan Details

Research

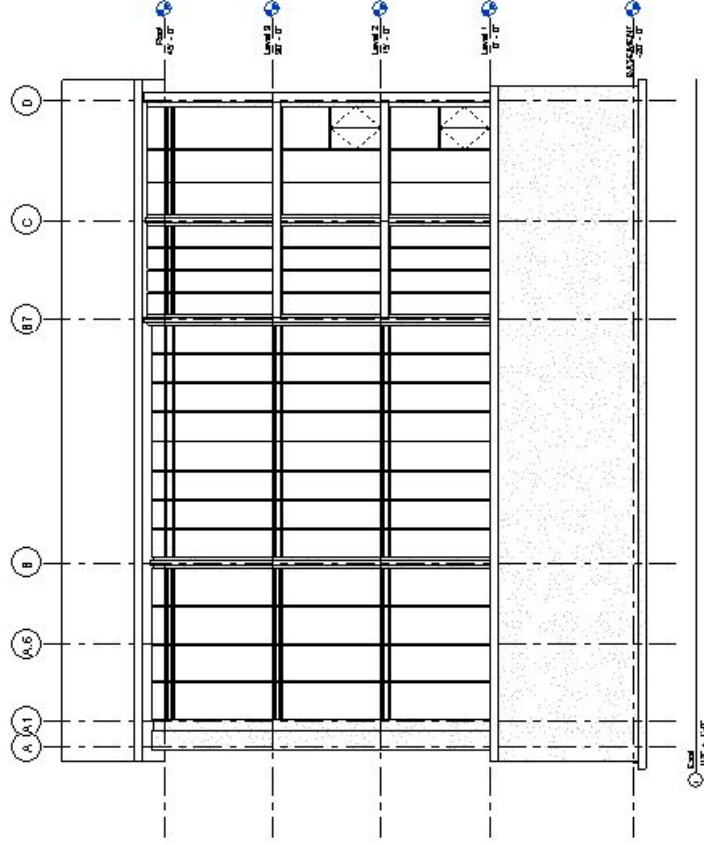
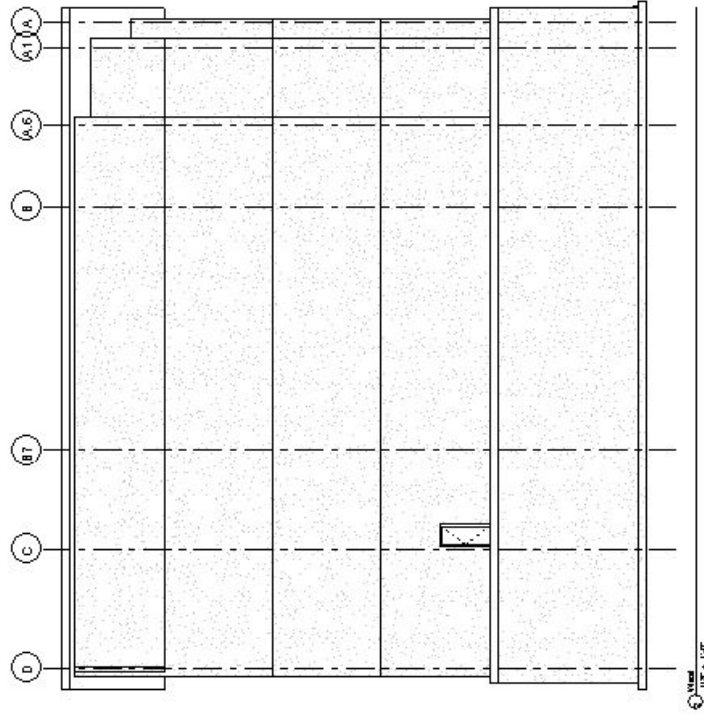

Structural Framing

Floor plans

RCF

Elevation & sections

Partitions, Wall Section & Plan Details

Research

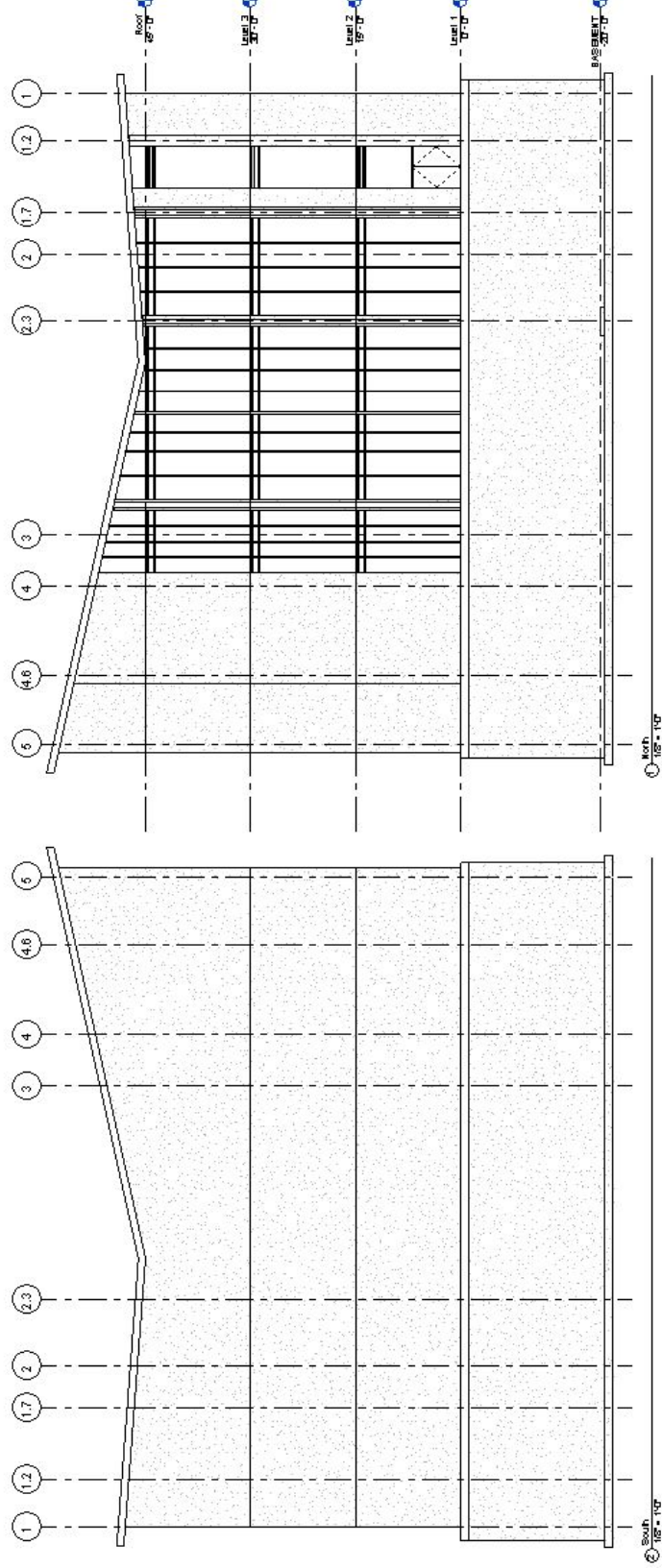

Structural Framing

Floor plans

RCF

Elevation & sections

Partitions, Wall Section
& Plan Details

Research

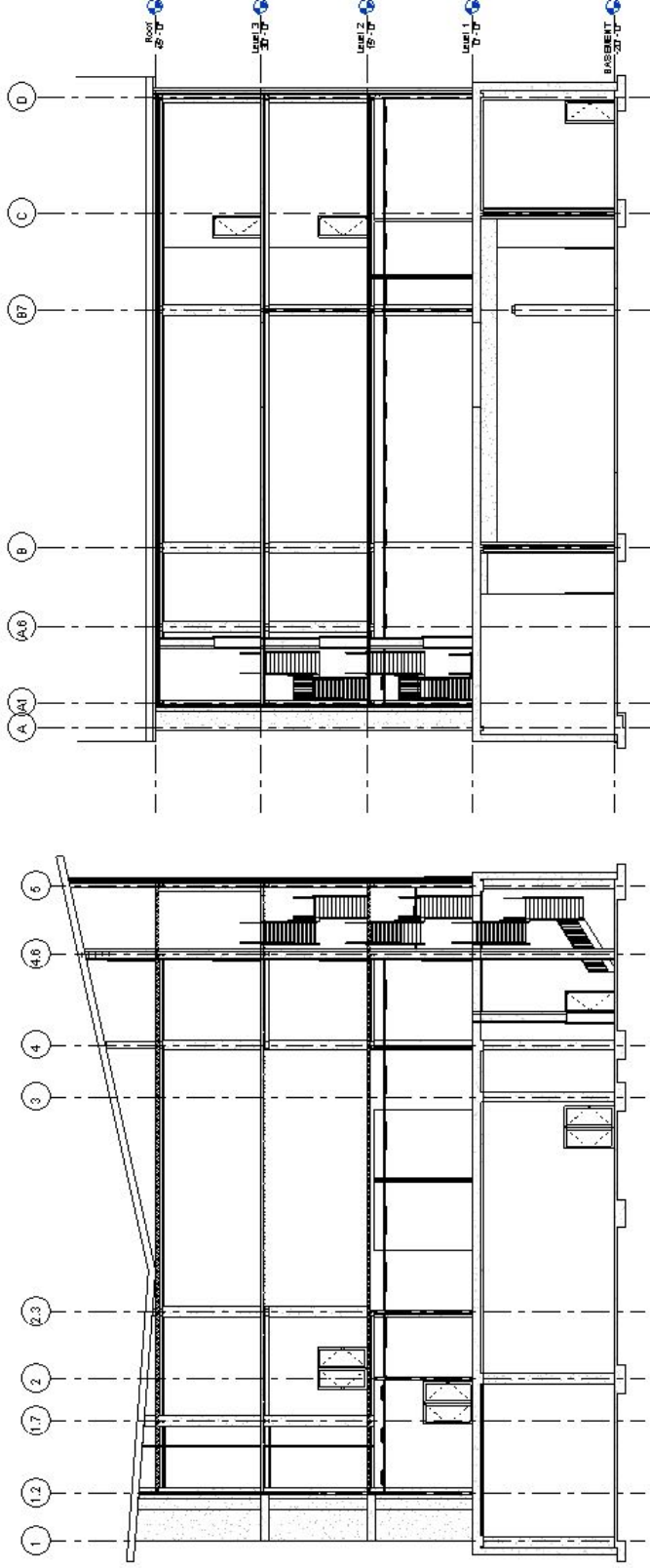

① Elevation/Section Copy 1
Fig = 109

② Elevation/Section 2
Fig = 109

Structural Framing

Floor plans

RCF

Elevation & sections

Partitions, Wall Section
& Plan Details

Research

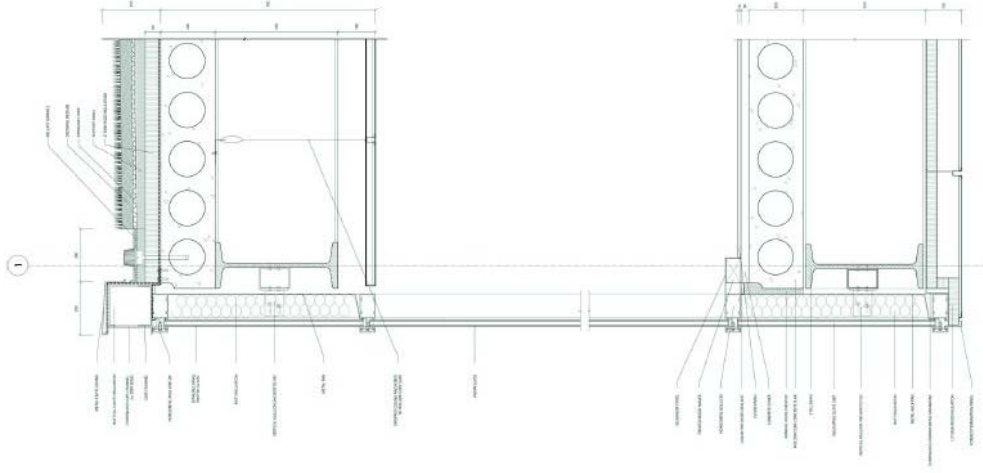
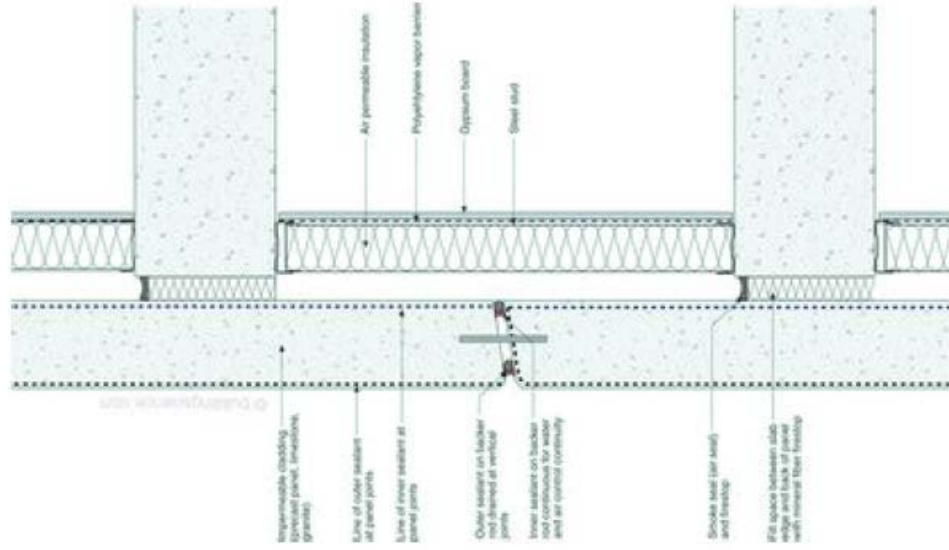

Structural Framing

Floor plans

RCF

Elevation & sections

Partitions, Wall Section & Plan Details

Research

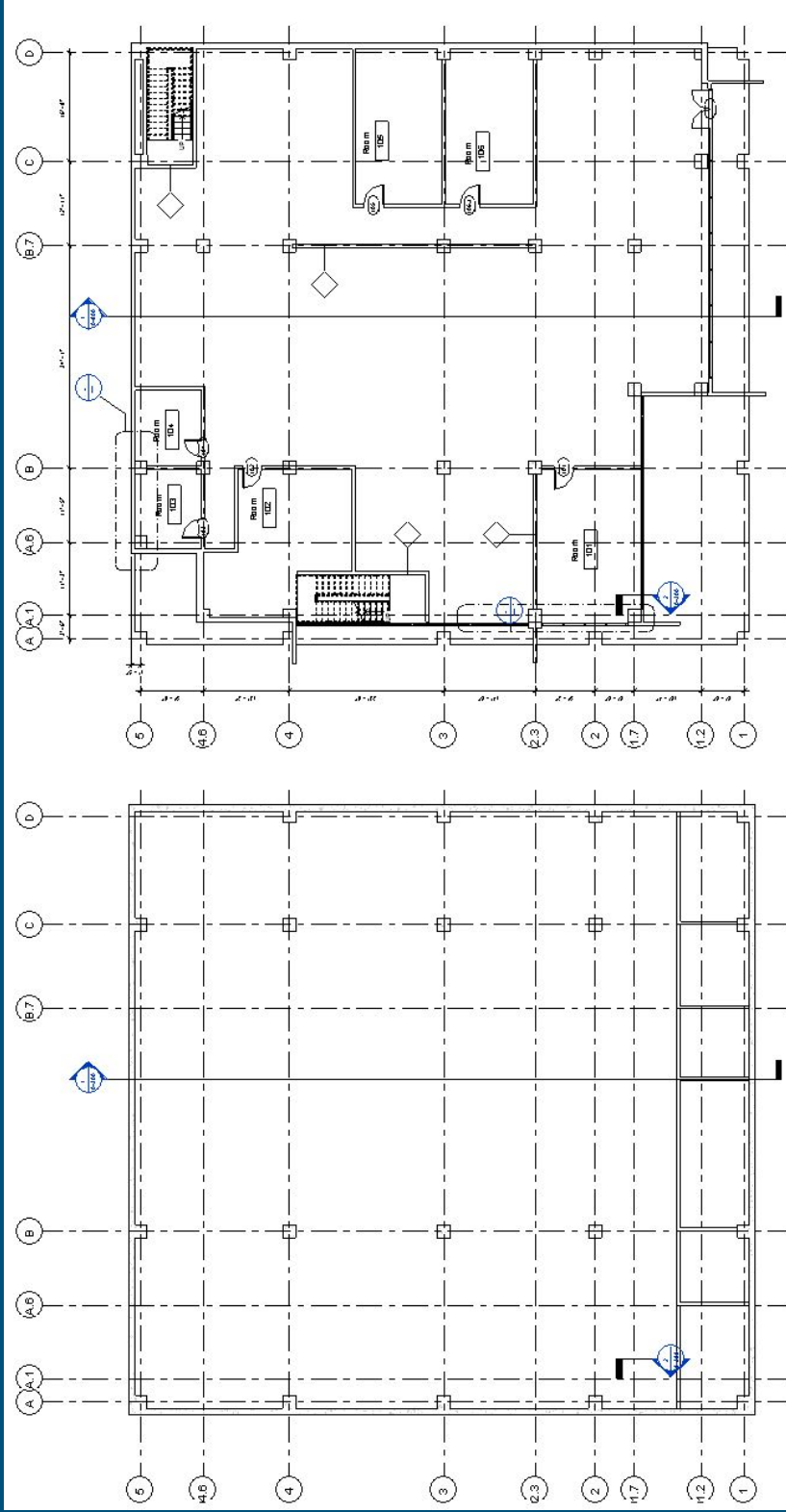

① First Floor Plan
Fig. - 109

② Basement, Copy 1
Fig. - 108

Dimelo Delvis Disla



No.	Description	Date

**DELVIS DISLA
HEALTH CLUB
PLAN DETAILS**

Project Number: 62520718
 Date: DELVIS DISLA
 Drawing: PLAN DETAIL
 Scale: **A401**
 1/16" = 1'-0"

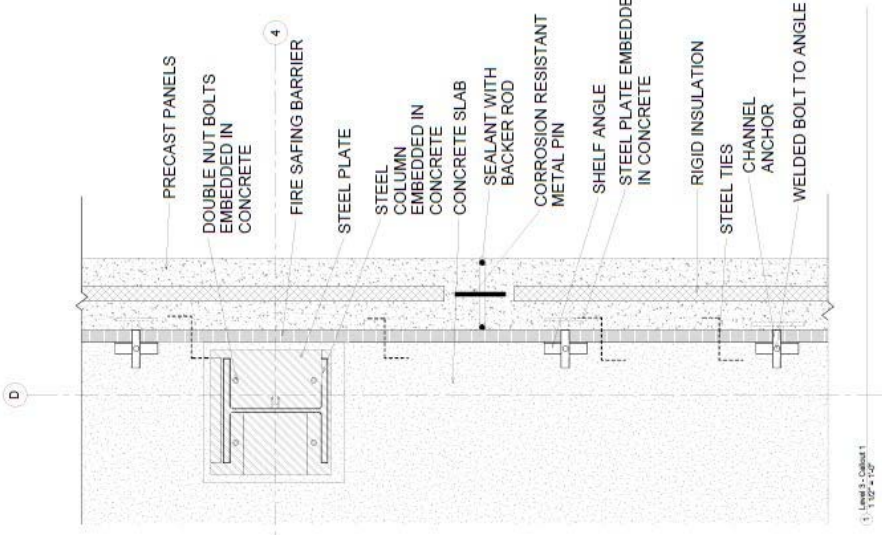

1. Level 3 - Column 1
1/16" = 1'-0"

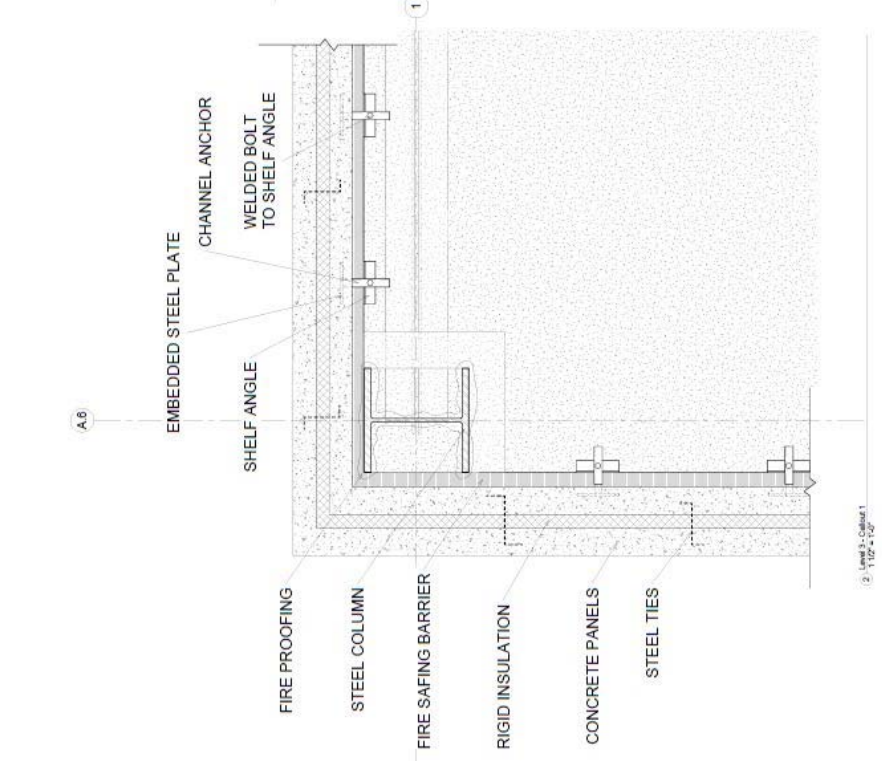

2. Level 3 - Column 1
1/16" = 1'-0"

Renso Valerio



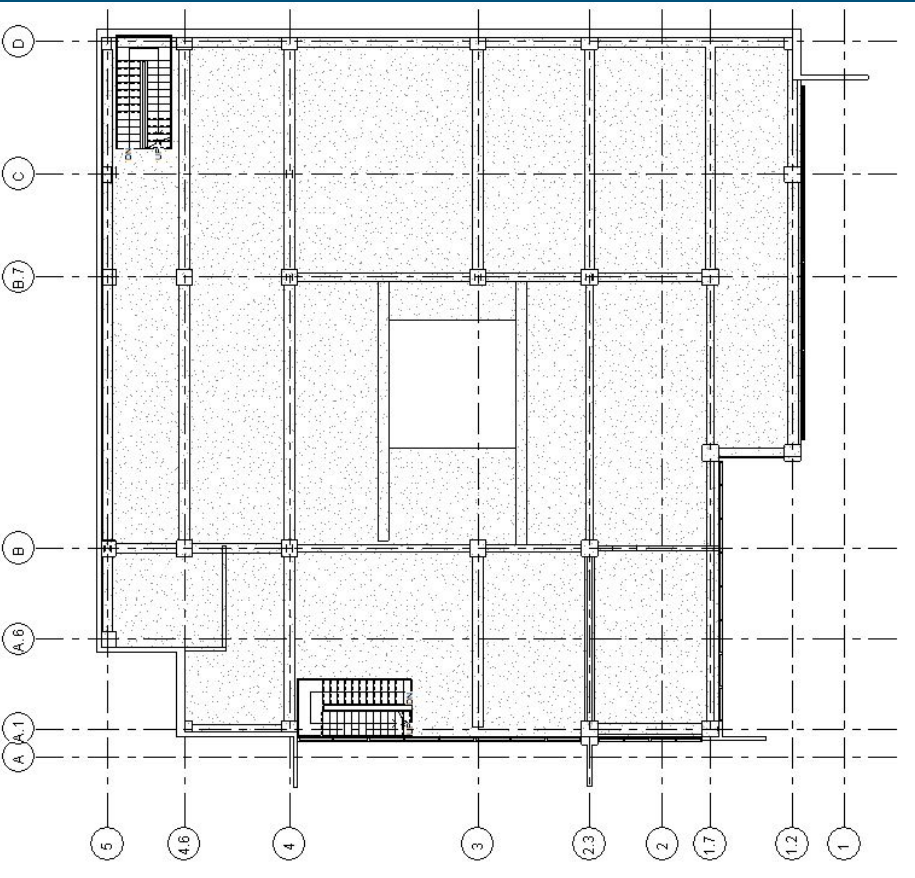
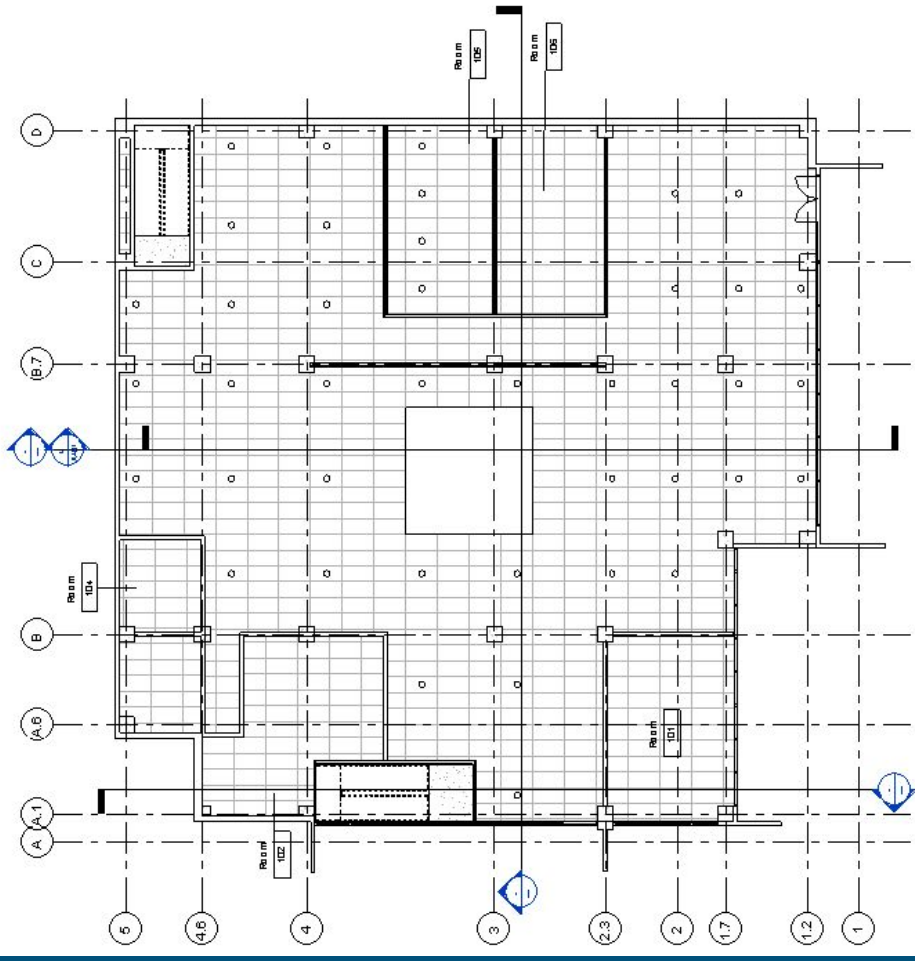

RCP

STRUCTURAL FRAMING PLAN

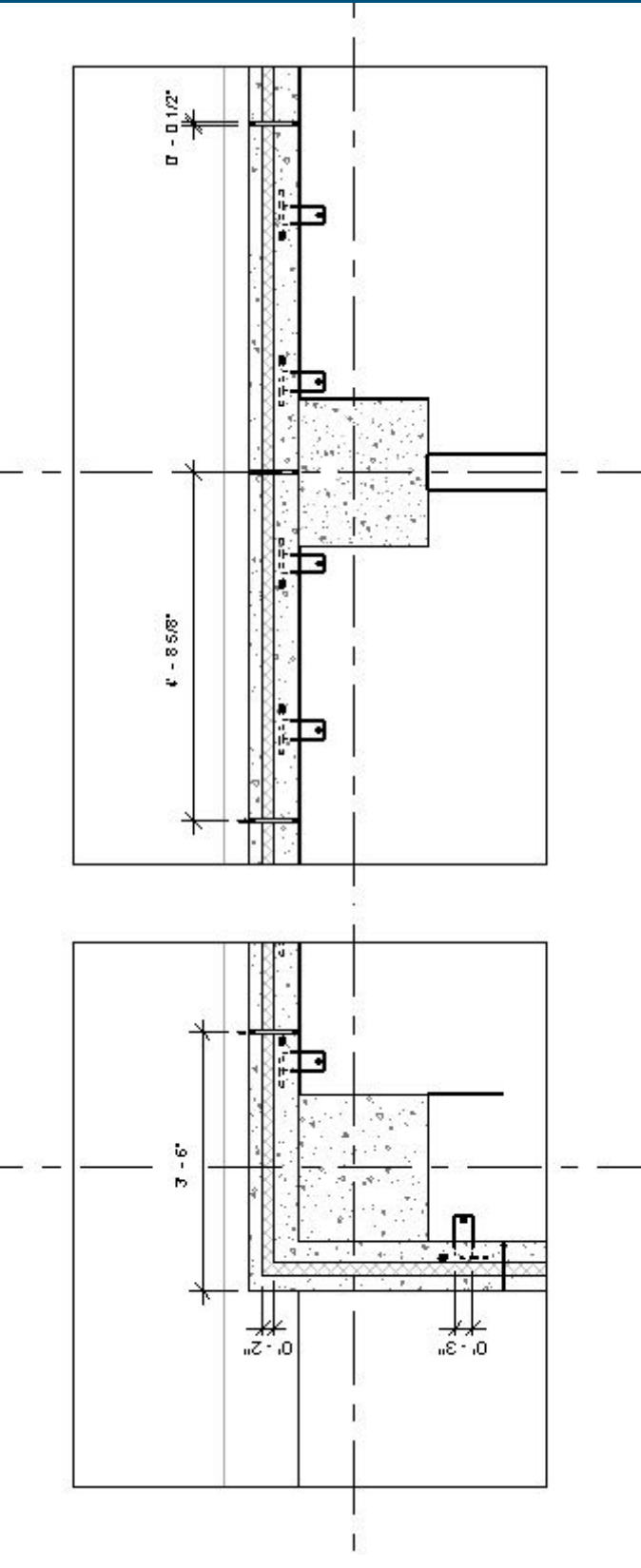

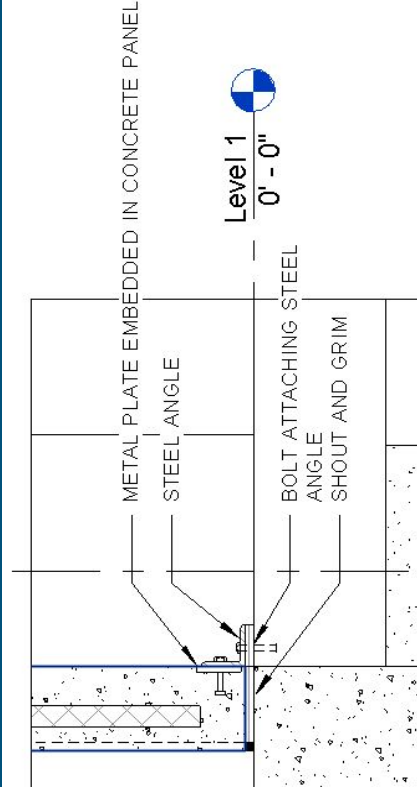
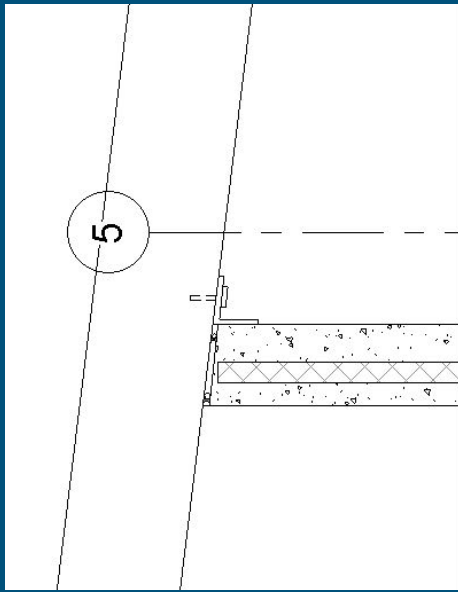

METAL PLATE EMBEDDED IN CONCRETE PANEL

STEEL ANGLE

BOLT ATTACHING STEEL

ANGLE
SHOULDER AND GRIM

SANDWICH STYLE PRECAST CONCRETE PANEL

VERTICAL CAULK AND JOINT

2" THERMAL INSULATION

STEEL PLATE EMBEDDED IN CONCRETE PANEL

STEEL C CHANNEL ATTACHED TO STEEL PLATE

BOLT THROUGH C CHANNEL

BOLT WELDED TO STEEL Level 3

ANGLE - 0 5/32"

STEEL ANGLE ON CONCRETE

ANCHOR REINFORCING STEEL ANGLE

FIRE SAFING

STEEL BEAM

CAULK AND JOINT

METAL PLATE TEING
CONCRETE PANELS
TOGETHER

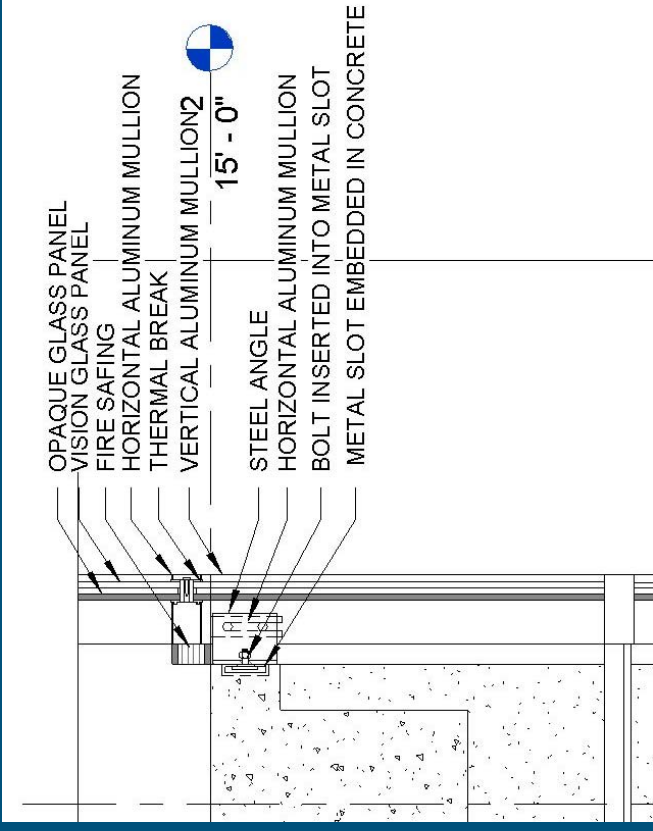
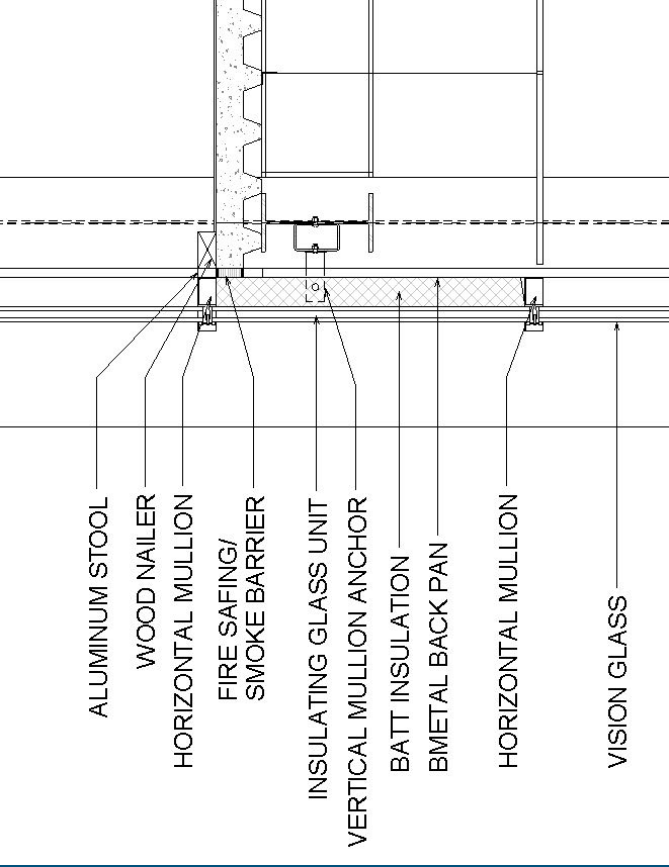

SPANDREL DETAIL COMPARISON

<http://www.tboake.com/SSEF1/rose2.shtml> - TRUSSES

<http://www.citywideprecast.com/insulated-panels/> - PRECAST PANELS

<http://www.oldcastleprecast.com/plants/building-systems/Pages/default.aspx> - PRECAST PANELS

<http://www.usgdesignstudio.com/download-details.asp?search=Spandrel%20Wall> - PARTITIONS

<https://www.pilkington.com/en-gb/uk/products/product-categories/decoration/pilkington-spandrel-glass> - SPANDREL PANEL