

**EMT 1130**

**ELECTRO-MECHANICAL**

**MANUFACTURING**

**LABORATORY**

(REVISED F2014)



## Schedule of Projects

Projects	Session
Orientation and Safety	1
Measurement & Tools	
Wiring Exercise & Handouts	2
Sheet Metal Boxes	
Bottom Section	3
Top Section	4 & 5
Power supply	6
L.E.D's and Drivers	7 & 8
DPDT Toggle Switches	9
Momentary Switches	10 & 11
Logic Probe	12
555 Timer	13
Final Assembly Digital Trainer	14 & 15

## TOOLS REQUIRED FOR COURSE

### A. The following tools are required by the 2<sup>nd</sup> session:

Steel Ruler 6" with graduations of 1/64, 1/32, 1/16 & 1/8  
Safety Goggles  
Soldering Iron with Stand (15 watts to 35 watts)  
Solder for electronic components 60/40 Rosin Core  
Sand paper one sheet (fine grade)  
Long Nose Plier 6"  
Diagonal Cutter 6"  
Wire Stripper  
Sponge  
Rag  
Soldering Paste (A tin of paste is much easier to use than a tube.)

### B. Tools required by the 3<sup>rd</sup> session:

Metal Scriber  
Center Punch  
Screwdriver 6" with 3/16 tip

### C. Optional

Shop Apron  
Fine Point Sharpie (Red, Blue, or Yellow) to mark hole size, etc. on bare metal parts.

A: Tools 130

## Parts for Sheet Metal Box

Description	Quantity
Sheet Metal Screws, #6 (1/4") pan head Radio Shack Part #64-3016	8
Rubber Feet Radio Shack Rubber Feet #64-2342	4
Spray Paint – "Rustoleum"	1
3/8 x #6 Machine Screw with Lock Washer And Nut (To mount Transformer)	2

### NOTE:

All Spry painting must be done at HOME!

Spray paint both the inside and outside of box to prevent rust.

Sand first to scuff up surface so paint sticks.  
Apply thin coats and let it dry. Stay back 8 – 12 inches  
So paint doesn't get too thick and run.

Parts List  
Power Supply

<u>Description</u>	<u>Qty</u>
PC Board	1
+5 V Regulator, 7805	1
Heat Sink, TO- 220	1
Capacitor, 2200 <i>uf</i> - 16 – 35 Volts	1
Diodes, Silicon 1 Amp (1N4001)	2
Transformer 12.6 Volts (1.2 Amps min)	1
Line Cord (3 prong plug)	1
Strain Relief (for size cord)	1
Heat Shrink Tubing 1/8	1 set
PC Board standoffs	4
Solder, 60/40 Rosin Core (.032 dia.)	1 set
Screws (for PCB standoffs)	8
Ribbon Cable	1 set

## L.E.D'S AND L.E.D. DRIVE

DESCRIPTION	QTY	SYMBOL
100 Ohm ½ Watt Resistors	5	R1-R5
4 700 Ohm ½ Watt Resistors	5	R6-R10
NPN Transistors (General Purpose)	5	Q1-Q5
Light Emitting Diodes (L.E.D's)	5	LD1-LD2
L.E.D. Holders	5	
Terminal Strips (8-Terminal Feed Through)	3	
14 pin Socket	1	
14 pin Dip Connector	1	
<b>TOGGLE AND MOMENTARY SWITCHES</b>		

Description	QTY	Symbol
1000 Ohm ½ Watt Resistor	8	
Toggle Switch, DPDT (6 poles)	4	S1-S4
Momentary Switch SPDT (Must have 3 poles)	2	S5-S6
7400 IC (NAND Gate)	1	IC-1
14 Pin Socket	1	
16 pin Socket	1	
16 pin Dip Connector	1	

NOTE: RESISTOR COLOR CODE IS ON PAGE 62

## Logic Probe and 555 Timer

Description	Qty.	Symbol
470 Ohm 1/2 Watt Resistor	1	R1
500 Ohm 1/2 Watt Resistor	1	R2
1 Meg Ohm Potentiometer	<u>1</u>	
1 uF Capacitor (Non-Polarized)	1	C1
Diode, Silicon (1N4001) (General Purpose)	1	D1
L.E.D.'s (1 Red, 1 Green) (Light Emitting Diode)	2	
L.E.D. Holders	2	
7404 IC (Hex Inverter)	1	IC-1
555 IC (Timer)	1	IC-2
14 Pin <u>SOCKET</u>	1	
8 Pin <u>SOCKET</u>	1	



## SOURCES OF ELECTRONIC PARTS

Dale Electronics  
7 East 20<sup>th</sup> St.  
New York, N. Y.  
212-475-1124

Electronic Warehouse Corp.  
1910 Coney Island Ave.  
Brooklyn, NY  
718-375-2700

Metro Electronics Co.  
81 W. Broadway  
New York, N.Y.  
212-233-4245

Packard Electronics Co.  
33 Union Square West  
New York, N.Y.

Ramco  
365 Canal St.  
New York, N. Y.  
212-966-6056

Rosetta Electric Co.  
73 Murray St. or 21 W. 46<sup>th</sup> St.  
New York, N.Y.

Sylvan-Wellington  
269 Canal St.  
New York, N.Y.  
212-226-5811

Radio Shack  
34 Willoughby St.  
Brooklyn, N.Y.  
718-858-8777

### Mail Order List

Digi-Key Corp.  
PO Box 677  
Third River Falls  
MN 56701-9988

JDR Microdevices  
110 Knowles Drive  
Los Gatos, CA 95030

Jameco Electronics  
1355 Shoreway Rd.  
Belmont, CA 94002

ELECTRONIX EXPRESS  
365 BLAIR ROAD  
AVENEL, NJ 07001  
732 381 8021  
www.elexp.com  
email: electron@elexp.com

# SAFETY

## GENERAL DISCUSSION

Safety cannot be over-emphasized. It is everyone's responsibility from the head of the school down to the student. Since moving machinery and electrical voltage provide opportunities for numerous accidents, above the ordinary opportunities that occur in everyday activities, this exercise has special importance. For this reason, it is introduced as early as possible in the course and the basic principles encountered should be applied in all everyday activities. Perhaps by pointing out dangerous acts or areas of potential hazard, it will increase student awareness and thereby prevent or preclude accidents before they happen.

Sight is one of your most valuable assets and every means possible should be taken to protect it. Therefore eye protection **MUST** be worn when:

- a. operating any moving machinery
- b. soldering
- c. handling acid and when operating the printed circuit board (PCB) etcher
- d. painting

Safety goggles should be obtained by **ALL** students and it is proper to expect each student to purchase his own inexpensive goggles for his own eye protection. How easy it is for a chip to be flicked off a piece of material being cut by moving machinery! Even a simple pair of hand diagonals can make the end of a piece of wire become a flying projectile that has caused loss of sight when striking the eye. The apparently simple process of flicking molten solder from a soldering iron tip has been equally destructive. Also, acid flung from a small hole in an acid etcher has caused loss of vision in more cases than would at first seem possible to believe. Even if accidents such as these were not recorded, the possibilities are obvious. This alone is justification enough to **DEMAND** that eye protection be worn at all times while in the laboratory. Be certain that blindness does not happen to you because you thought you could get away with not wearing your safety glasses this one time.

Since the same laboratory is often used for both etching PCB's and fabricating, any student in the lab may be exposed to the chemicals used in PCB processing. Therefore, when working with acid always wear rubber gloves, safety glasses, and an apron. Chromic sulfuric acid in an open cut will slow down healing, in most cases, and can cause serious reaction in some people. If you should get acid in your eyes, rinse them out thoroughly at the eye wash station or by holding them under a running fresh water faucet. Immediately, notify the instructor.

The student is not to operate any shop machinery unless he has been instructed in its use. Certain pieces of moving machinery are especially dangerous and should require two students while being operated. One of the students will be using the machine to perform the required, or desired, work while the other student will stand by the **OFF** switch in order to turn the moving machinery off, if necessary, for whatever reason. The wearing of loose clothing (necktie, bracelet, long sleeves, etc.) can provide a situation whereby the operator could be caught in the moving machinery. Were it not for the "buddy system", with the second student standing by, it might not be possible for the machine to be turned off prior to the inflicting of serious injury. The "buddy system" is especially applicable when using such moving machines as the drill press, band saw, lathe, etc.

In the general area of hand tools, there are several self-evident points that can be made. Never carry sharply pointed tools in your pocket(s). Punches that have chipped or mushroomed heads should never be used. Be certain that all tools requiring handles have them. This is especially true with regard to files. Always de-burr immediately all new edges after cutting, drilling, punching, or shearing metal. De-burring can be done with a de-burr tool or with a smooth file. Do not over file or the edge will become rounded and uneven.

When using the air pressure hose and nozzle to blow dust out of a chassis, eye protection must be worn as small bits of solder can be blown out at high speed. Never hold an air nozzle against the skin as air can get into the blood stream and cause death.

Common sense is perhaps the most important advantage a student may have in any particular situation. Develop the valuable habit of thinking ahead in order to insure that all possible accident preventative measures have been taken so that the possibility of an accident occurring is non-existent. Since it is impossible to cover **ALL** the possible ways in which accidents can occur or develop, the instructor will point out the numerous situations that develop in the laboratory, during continuous use, which can serve

to prevent dangerous situations from developing to cause accidents, or to permit accidents to happen. This will be especially true with regard to rotating machinery and electrical voltages. Accident prevention will be part of every laboratory exercise.

Knowing the location of fire extinguishers is most important. Take the time to learn where they are as soon as possible. Be aware, also, that water or soda ash type substances should not be used on electrical fires. Carbon Dioxide (CO<sub>2</sub>) type extinguishers should be used on electrical type fires. Learn how to operate the various types of extinguishers so no time is lost if the need arises.

Sounding the alarm or sending for help should be one of the first steps taken in any emergency or dangerous situation where special help is needed. In many schools or facilities, notifying the switchboard operator, if available, can insure immediate assistance. Remember to give the operator the nature of the emergency and your location. If the facility does not have a switchboard operator, calling the telephone operator would tend to serve the same purpose.

Electrical hazards are very common in the laboratory and, in particular, the 120 volt Alternating Current (A.C.) power outlet and power cord wiring is dangerous. Respect these high voltages because they are enough to **KILL** you. Know proper emergency procedures. Mouth-to-mouth resuscitation should be given to an electrical shock victim. If a person has received a severe electric shock and is unconscious:

- a. Turn off or remove the power from the victim if he is still receiving shock
- b. Send for help.
- c. Give mouth-to-mouth resuscitation.

**NOTE:** Mouth-to-mouth resuscitation consists of laying the victim on his back; clearing the mouth of obstructions (observe that the tongue has not receded into the throat and is not blocking air flow); pinching the victim's nose; and then breathing into the victim's mouth approximately 12 times per minute. This should be continued until the victim revives, you are properly relieved, or a doctor pronounces the victim dead.

With regard to power outlets, Figure 1-1 shows both the new and the old 120 volt AC wall outlet receptacles. Notice that in the newer outlet receptacle, the neutral insert is longer than in the older type. Also, the newer outlet receptacle has a ground insert whereas the earlier style simply had two outlets of the same size and no ground insert. The box itself is grounded (connected) to the power line ground. Whenever a three pronged plug attached to a 3-wire power line cord, as shown in Figure 1-2, is desired to be inserted into the earlier type wall outlet receptacle, a 3-way to 2-way adapter, as shown in Figure 1-3, is required.

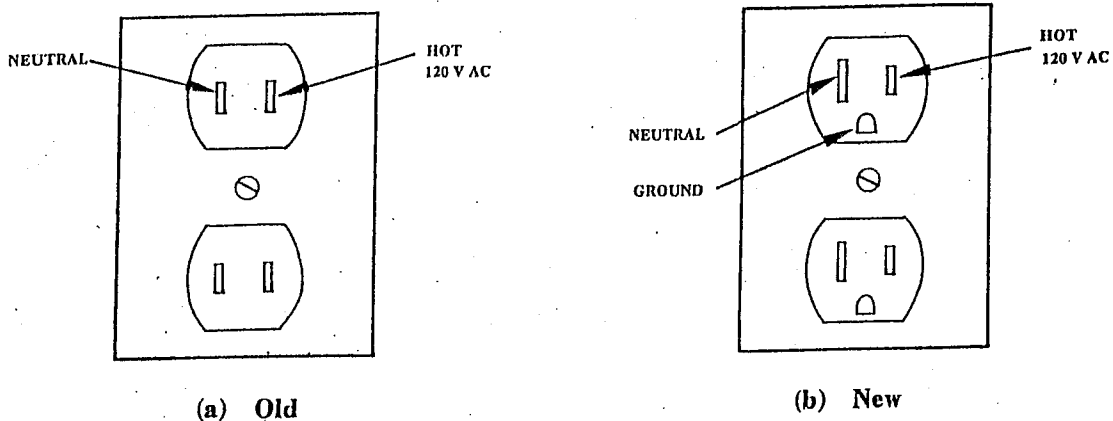


FIGURE 1-1: 120 Volt AC Wall Outlet

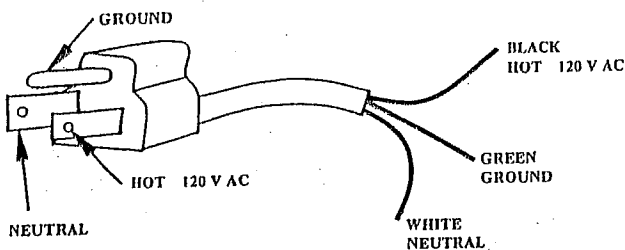


FIGURE 1-2: Power Line Cord

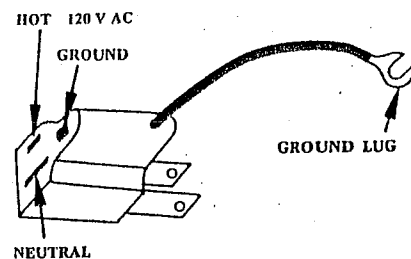


FIGURE 1-3: Ground Adapter — 3-way to 2-way

The color coding associated with the power line 3-wire cord is also shown in Figure 1-2. The black colored lead is connected to the 120 volt AC hot line from the generator. The white colored lead is associated with the term neutral and, in fact, connects to the other output side of the generator. The green colored lead is connected with the generator and electrical circuit ground. Color coding is also practiced in electronic wiring but, as compared to electrical wiring practices, the color black is associated with the neutral or ground side of an electronic circuit. Knowing this should provide some safety precaution.

For example, caution should be exercised when introducing 120 volt AC power from a line cord to a piece of electronic equipment. Good wiring practice dictates that neither the black nor the white power line cord wires be connected to the chassis of the electronic equipment. AC-DC pieces of electronic equipment do connect one side (white) of the power line cord to ground of the electronic circuit directly, but Underwriters Laboratories (UL) requires that this circuit ground be isolated from the metal chassis or case of the piece of electronic equipment.

When working on electrical or electronic circuits, extreme care should be exercised when exposed voltages are involved. Before energizing the circuit, be certain to obtain the instructor's permission. Never leave the live circuit unattended where some one can walk by, touch the circuit, and possibly receive an electric shock. Likewise, never take anyone's word that a circuit is not energized. Make sure that the power cord is removed from the wall outlet or power source. And always remember that capacitors can store a lethal charge. A stored capacitor charge can be removed by shorting, carefully, the terminals of the capacitor with a well insulated jumper cord or, if one side of the capacitor is connected to ground, with a ground bar.

Also, with regard to electrical dangers, never work on a wet floor or stand in water because this can permit a circuit to be completed through your body. It is the current flowing through the heart muscle that causes it to seize and death can result. So, wherever possible, keep one hand in your pocket so that a circuit can not be completed from one hand to the other through the chest and thus the heart muscle.

Get permission from the instructor before using a "suicide cord". A "suicide cord" is a power cord that has alligator clips on one end and a plug on the other. When plugged into a 120 volt AC receptacle, it provides high voltage at the alligator clips. Obviously, it must be used with care — if at all.

Never work alone on live circuits because, if an electric shock should occur, there would be no one to assist you or run for help. You could get across a voltage source and be unable to free yourself. Whereas, if some one is nearby, they can hear you call for help or, hopefully, see your desperate situation.

Remove rings and wrist watches with metal bands when working around electrical sources which can provide high current. The shorted circuit (through a ring or watch band) can cause the jewelry to become red hot and may result in the loss of a finger or a hand.

Use an isolation transformer when working on electrical equipment that has one side of the chassis, or circuit ground, connected directly to one side of the power line plug. The appropriate use of a three wire line power cord (Figure 1-2) will prevent this from happening. Unfortunately, there are times when the wall receptacle will not accept a three pronged plug. This necessitates the use of a three-way to two-way adapter (Figure 1-3). It is possible for the two-pronged plug of the three-way to two-way adapter to be inserted in a manner that insures proper grounding. As shown in Figure 1-1(a), a simple 180 degree reversal would permit this to occur. Looking at Figure 1-1(b), notice that a polarized, two-pronged plug would insure proper grounding because the neutral prong is wider and thereby allows the plug to be inserted only one way.

When handling paints and solvents, be sure that the fumes are not inhaled as they are very toxic. If possible, paint outdoors away from the shop or laboratory area. Remember that paints and solvents should be stored in a yellow type paint locker for immediate recognition and that they are highly flammable. Use tri-chlor — or other solvents — under a hood, with an exhaust fan turned on.

## **SAFETY TEST**

The safety test which follows requires a perfect grade. So, read the information in this chapter well. Also, read the question carefully before choosing your answer.

## **SAFETY STATEMENT**

The safety statement is to be signed, in ink, by the student and given to the instructor, properly completed, by the end of this laboratory exercise.

# HAND TOOLS

## GENERAL DISCUSSION

Hand tools are used continuously in all aspects of electronic fabrication. A knowledge of their proper use simplifies work by enabling the user to select the "right" tool for a specific application. The following tools are those most commonly used when working with electronic hardware.

**LONG NOSE PLIERS:** Long nose pliers have long slender jaws. they are used to reach into hard to get places and hold, or grab, small parts, wires, hardware, etc. Long nose pliers are delicate and should not have much force applied to them.

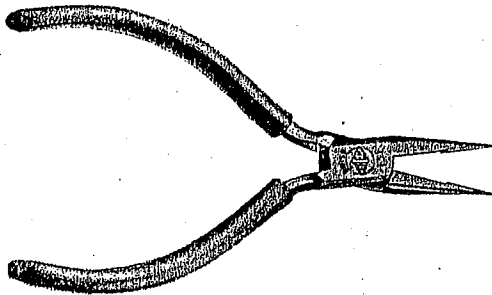


FIGURE 2-1: Erem Long Nose Pliers

**DIAGONAL CUTTING PLIERS:** The diagonal cutting pliers, sometimes called dikes, are used to cut wire. The jaws are fairly brittle and may break if care is not taken when attempting to cut a wire too large for the cutters. They should not be used for stripping insulation from wire because they can nick and weaken the wire.

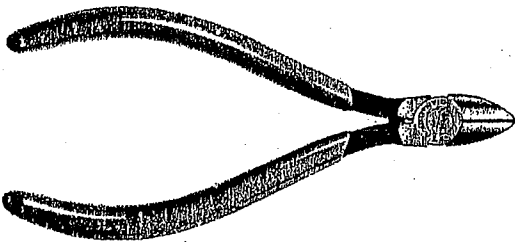


FIGURE 2-2: Diamond Diagonal Cutting Pliers

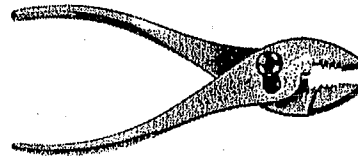


FIGURE 2-3: Xcellite® Slip Joint Pliers

**SLIP JOINT PLIERS:** Slip joint pliers were designed for holding heavy stock. The slip joint permits handling of larger diameter or larger sized material.

**SLOTTED SCREWDRIVER:** The slotted screwdriver is used to tighten or loosen screws. It is used with the standard slotted screw and is identified by blade length. Never pound on screwdriver handles with a hammer.

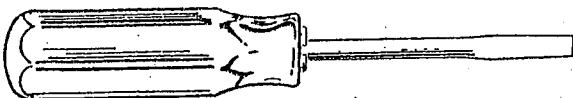


FIGURE 2-4: Xcellite® Slotted Screwdriver

**PHILLIPS SCREWDRIVER:** The phillips screwdriver is used to tighten or loosen screws with a cross head opening or phillips head screw.

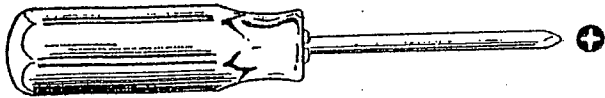


FIGURE 2-5: Xcelite® Phillips Screwdriver

**SCREW HOLDER:** The screw holder is used when working around power panel terminal blocks with live power where a dropped screw can short out circuits. It is also of assistance when placing a screw in out-of-the-way, hard-to-reach places.

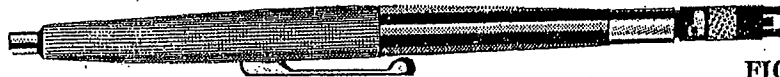


FIGURE 2-6: Stanley Screw Holder

**NUTDRIVER:** The nutdriver is used to tighten or loosen nuts. They come in sizes from 3/32 inch to 1/2 inch and can be purchased in color-coded sets with 10 sizes to a set. They are extremely efficient in tightening or loosening hexagonal headed screws or nuts — particularly those in hard-to-reach places.

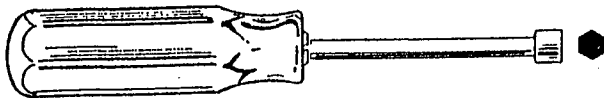


FIGURE 2-7: Xcelite® Nutdriver

**ADJUSTABLE WRENCH:** A wrench is used to tighten or loosen nuts. The adjustable wrench permits the capability of one wrench that will fit virtually any size nut within the span of its adjustment. It is similar to an open end wrench except that one jaw is variable. This jaw can be moved by means of an adjusting screw in the head of the wrench.

Adjusting the wrench for a proper fit is a simple procedure. The jaw is opened sufficiently to permit both jaws to slip over opposite flats of the nut. The adjusting screw is then turned until the movable jaw grips the flat firmly. Always remember to pull the wrench handle toward the movable jaw direction. This prevents excessive force from being applied to the movable jaw and this procedure should be followed whether tightening or loosening a nut. Care should also be taken not to round the corners on the nut.

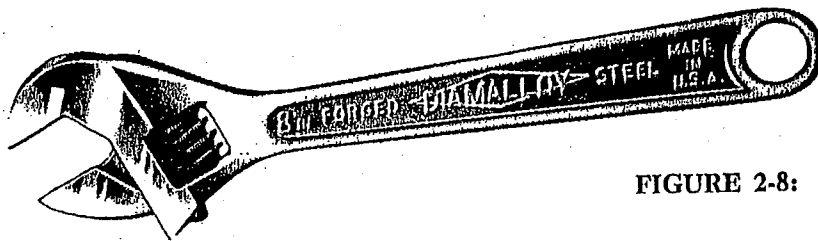


FIGURE 2-8: Diamond Adjustable Wrench

**BALL PEEN HAMMER:** The ball peen hammer, with its special spherical end, is generally used for riveting or peening operations. Peening is the hammering of metal, so as to compress or indent it, in order to stretch or expand the metal adjacent to the indentation. A ball peen hammer can be damaged if it is used directly on an anvil or large hard surface.

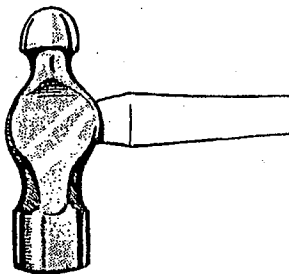


FIGURE 2-9: Ball Peen Hammer

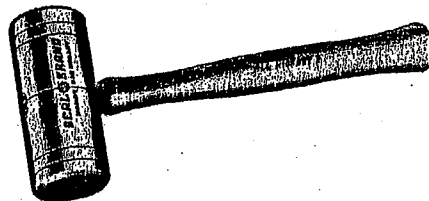


FIGURE 2-10: Seal Brand Mallet

**MALLET:** The mallet is a form of hammer which has a wide head made of wood, lead, or rubber. It is used for hammering sheet metal to keep it from being stretched or nicked.

**COLD CHISEL:** The flat cold chisel is used in chipping metal by striking the head of the chisel. A small cut is made each time the chisel is hit. Make certain that the face of the chisel is horizontal before striking it with a hammer.

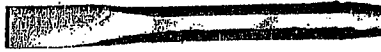


FIGURE 2-11: Cold Chisel

**HAND EXPANSION REAMER:** The hand expansion reamer is a crude, but effective, tool that can be used to enlarge holes slightly in thin gauge sheet material. The ream consists of a T-handle and six fluted cutting blades that run lengthwise along the reamer body to converge at the taper point. The six blades are necessary to minimize chatter along the edge of the hole as the reamer is turned to enlarge the hole.

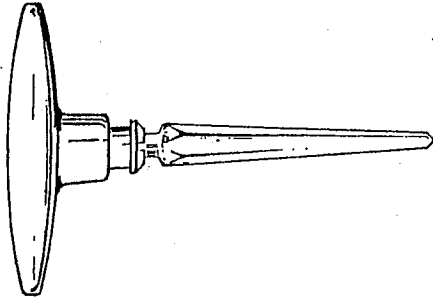


FIGURE 2-12: Xcelite® Hand Expansion Reamer

**FILES:** The file has a large number of cutting edges that act as small chisels to remove small chips of metal when moved back and forth by hand across a metal surface. In filing, pressure should be exerted on the forward stroke only, because the teeth or cutting edges are pointed toward the end of the file. Pressure on the return stroke produces no cutting action and tends only to dull the teeth.

Filing is a difficult operation for the beginner because it depends upon the motion of the hands without a means of guiding the tool to insure that it moves over the work in the correct direction. The correct method of holding the file and the proper position, therefore, are most important. The work should be at the proper height — about even with the elbows for light work and slightly lower for heavier work. The feet should be about 8 to 10 inches apart and at right angles to each other with the left foot being parallel to the file. The file should always have a handle which is held with the right hand — thumb on top and fingers below.

When the file is grasped by the ends and moved sidewise across the work, the action is known as draw-filing. It produces a smooth finish on narrow surfaces and edges, and it is used to remove tool marks that may have been left on metal. This is light filing and it produces a smooth surface.

Most filing operations begin with a coarse file and continue using successively finer grades until finally finishing with a smooth or dead smooth file.

Particles of metal, or pins, often remain in the teeth of the file, and they either reduce its cutting ability or scratch the work. These particles can be removed by using either a stiff brush or a file card. Frequent cleaning can be prevented, when filing steel, by using oil. However, cast iron should not be allowed to become greasy because the file will tend to slide without cutting into the metal.

**NOTE:** The teeth of a file are shaped to form a cutting edge similar to that of a very small chisel. Single cut files are made with a single set of teeth cut at an angle of 65 degrees to 85 degrees. They are generally used with light pressure to produce a keen edge on a knife. Double cut files are made with two sets of teeth that cross each other. One set is cut at approximately 45 degrees and the other set is cut at between 70 degrees and 80 degrees. They produce a coarser finish.



FIGURE 2-13: Simonds Hand File and Handle



# METAL SHEARING

## GENERAL DISCUSSION

An easy way of cutting sheet metal is by shearing. This method of cutting metal is relatively fast and accurate, especially when larger size shearing machines are used. The best results for good layouts can most often be obtained by working from a 90 degree reference corner — where possible. Again, the thickness and type of metal to be sheared is most important as to the ease of cutting, and accuracy of the actual cut obtained. One difference between cutting and shearing metal is that sheet metal that has been sheared, in general, does not have to be de-burred or smoothed on the edges. However, many times the shearing process is so keen that the sheet metal edge is razor sharp and care must be exercised to make sure that a finger or hand is not cut on the sharp edges.

There are several type shears that are considered in this exercise. They are the hand shear (tinsnip), the bench shear, the corner notcher, and the foot operated squaring shear.

## HAND SHEAR (TINSNIP)

As the name indicates, the hand shear, shown in Figure 5-1, is operated by hand power. This obviously limits the size of sheet metal that can be sheared and it is recommended that the hand shear be used only to cut 20 gauge or thinner metal. It is used much like a pair of scissors to cut thin sheet metal such as aluminum. When cutting to a corner, set the snip so that the point will finish exactly at the corner. Prior to using, make sure that the bolt is tight and that the cutting blades fit closely against each other.

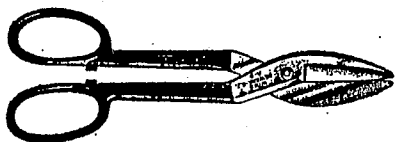


FIGURE 5-1: Wiss Hand Shear

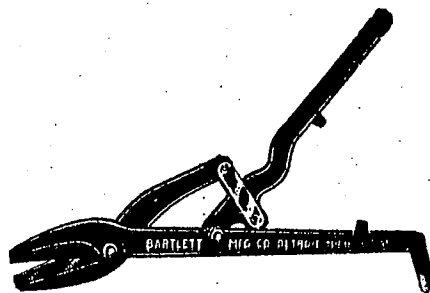


FIGURE 5-2: Bartlett Bench Shear

## BENCH SHEAR

The bench shear, shown in Figure 5-2, is nothing more than an enlarged version of the hand shear. The handles can vary from two to four feet in length. One handle can either be mounted in a vise, or otherwise fixed securely to the bench while the other handle is permitted to move up and down to do the cutting. Because of the limited size of the cutting surfaces and the fact that only hand power is used, aluminum larger than 16 gauge should not be sheared. If sheet steel is desired to be sheared with the bench shear, it is recommended that a maximum thickness of 22 gauge be used.

## CORNER NOTCHER

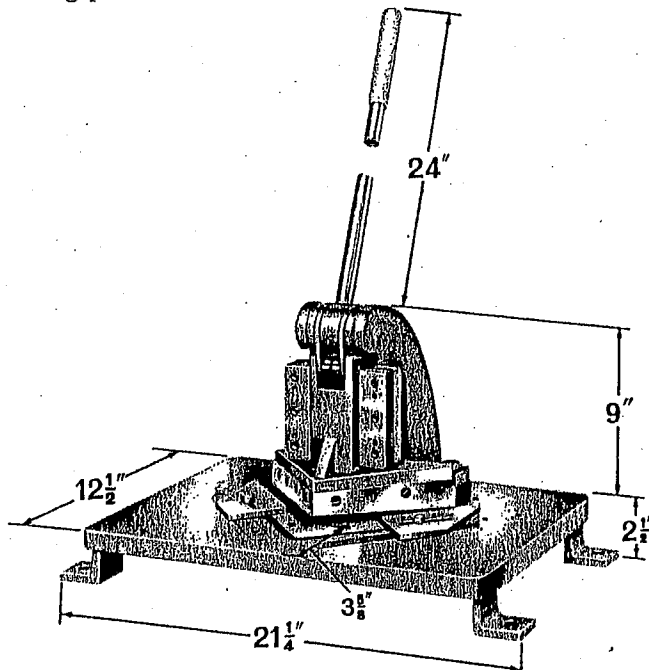
The corner notcher, shown in Figure 5-4, is a smaller type shear which provides for shearing thin sheet metal (aluminum up to 16 gauge and sheet steel up to 22 gauge) of short lengths or cutting a corner 90 degree notch. Outside angles less than 90 degrees or inside angles greater than 90 degrees can be sheared



by simply rotating the sheet metal to the desired angle scribed on the metal. This shearer is ideal for the purpose of shearing a 90 degree corner notch prior to bending up the sides of a metal box.

Be certain that the cutting edges are appropriately aligned and positioned for shearing action. This machine makes a very clear, burr free cut and is highly useful in sheet metal fabrication operations.

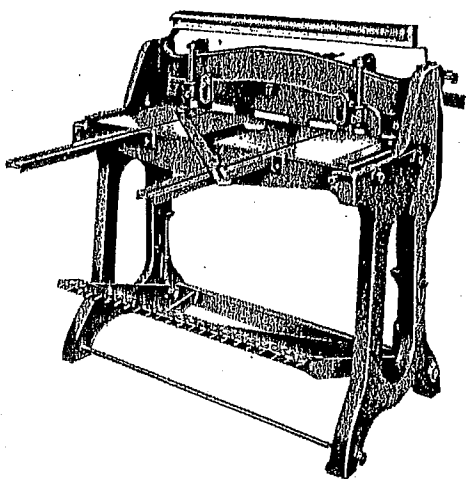
With regard to safety, be certain that fingers are kept clear of the blades and dies while shearing action is taking place.



**FIGURE 5-3: Roper Whitney Corner Notcher**  
*Courtesy of Roper Whitney, Inc.*

### FOOT OPERATED SQUARING SHEAR

As its name suggests, the foot operated squaring shear, shown in Figure 5-4, is operated by foot action and has the ability of cutting sheet metal with edges that are square, or 90 degrees, with respect to each other. The side guides must be accurately preset with the cutting blades to insure that the 90 degree cutting action is obtained. This shearer can be used to cut aluminum up to 16 gauge thickness or sheet steel up to a maximum of 22 gauge thickness.



**FIGURE 5-4: Roper Whitney Foot Operated Squaring Shear**  
*Courtesy of Roper Whitney, Inc.*

The back gauge is an auxiliary adjustment that can be set to permit the depth of entry of sheet metal when admitted to the cutting blades for shearing action. Thus it is useful, when many pieces of the same size are to be cut, because the back gauge can be preset and locked at the desired setting.

The hold down bar applies pressure to the sheet metal prior to the shearing action and prevents the sheet metal from being moved while shearing is taking place. This preserves the accuracy of the layout and provides edges with a finished cut that can be used for reference purposes.

Common safety precautions are necessary to make sure the legs and feet are kept away from the foot-treadle during shearing operations. Likewise, fingers should be kept away from the pressure bar and shearing blades during operation.

Many times it is desired to shear the sheet metal along a scribed line. This can be done easily by looking downward behind the hold-down bar and aligning the scribed line with the cutting edge of the shears. The accuracy of the shearing can be affected by the sharpness of the cutting edges of the shearer, the thickness of the material sheared, and the width of cut made. If the sheet metal being cut has any hidden stresses, they will be released by the shearing action and a straight cut will not be obtained. Because of this, it is suggested that an initial oversize cut be made if possible. The second cut can then be made in the manner of a trim cut.

Shearing longer, narrower strips may be a little more difficult due to bow or camber (curl). Bow is the tendency for a strip of narrow sheet metal not to remain flat. It can be reduced by giving a slight slope to the upper shearing blade where it can be done. Camber is where the narrow strip may have parallel edges, but wherein the edges are not straight, but form a long curve. This camber effect is influenced by the width of the strip in relation to its thickness, the metal being cut, and the slope of the upper shearing blade. When the strip is narrower in proportion to its thickness, then the camber will be greater.

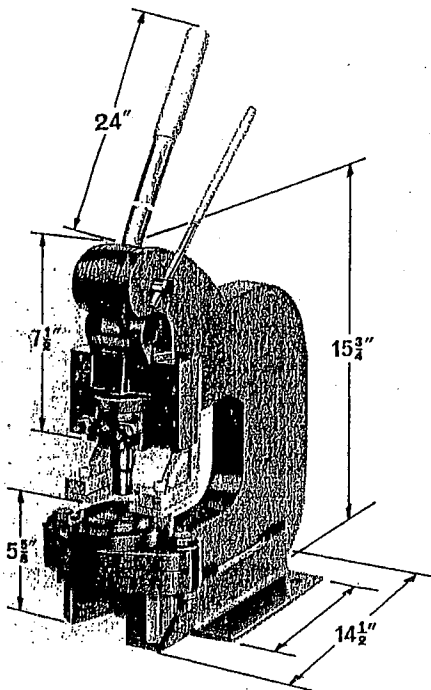
# HOLE PUNCHING

## GENERAL DISCUSSION

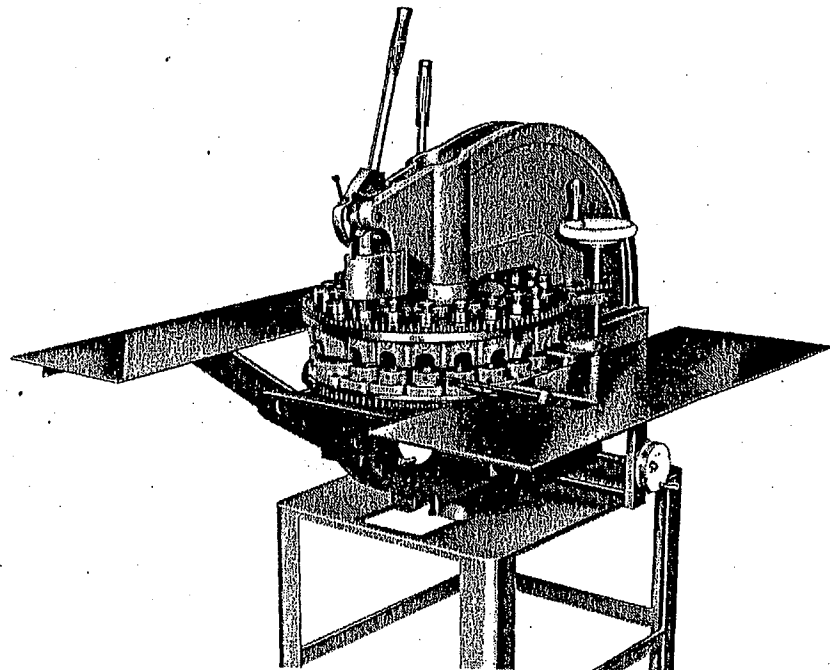
There are times when it will be necessary to punch a hole in a piece of thin gauge sheet metal. The hand operated punch press lends itself to this operation fairly well. Positive alignment between punches and dies is necessary in order to maintain tolerances. In this manner burr-free holes can be punched in the thinnest of materials. The punch is the "male" part that is generally mounted in the top part of the press and the die is the "female" part that is held securely in the bottom part of the press. Obviously, the punch outer diameter must be a few 0.1 thousandths smaller than the inner diameter of the die for proper punch action. Extreme care must be exercised when using a punch press to make certain that the alignment between the punch and die is accurate. Also, be sure that a punch larger than a die is not aligned when operating the punch as this can cause serious damage to the punch, the die, or both.

## HAND OPERATED SINGLE STATION PUNCH PRESS

The hand operated single station punch press, shown in Figure 6-1, requires proper selection of the correct size punch and die and their accurate alignment prior to a punching operation. As the name, "single station", suggests, only one size hole can be punched for any one setup of punch and die for the punch press. If various size holes need to be punched, it is suggested that the same size hole be punched as many times as necessary prior to changing the punch and die for another size hole.



**FIGURE 6-1: Roper Whitney  
Single Station Punch Press**  
*Courtesy of Roper Whitney, Inc.*



**FIGURE 6-2: Di-Acro Turret Punch Press**  
*Courtesy of Di-Acro Division, Houdaille Industries, Inc.*

In addition to the punching operation, many times the punch sticks in the material in which the hole has been punched. A stripper plate and stripper arms are available to be mounted to the press, which will

permit the withdrawing of the punch, allowing the material punched to be removed from the press. The proper positioning of the stripper plate is important to insure sufficient space for clearance of the metal to be punched and not setting it so high that the material may become distorted upon withdrawal of the punch during stripping action.

An additional feature, specifically on the Di-Acro Punch Press, is the use of side and back gauges to assure precision gauging for exact duplicating operations. These can be mounted on the press in such a manner as to insure proper location of holes to be punched in a mass production type operation. Ordinarily, the side and back gauges are not used and the location or alignment of the piece of metal to be punched is located by eye and manually positioning the punch for proper alignment before completing the punching stroke.

To properly set up the hand operated punch press for punching metal, insert the proper size punch in the punch holder and tighten the set screw. Next the die is inserted in the die holder and its set screw is tightened. The die holder is then mounted onto the punch press but not tightened firmly to the press. The handle is then pulled down until the punch enters the die accurately. Now the die holder is bolted firmly in place to the punch press. The "lineup" of the punch and die can be tested by inserting paper and punching by hand. A clean cut should be obtained. The correct notch in the stripper plate should be selected and the stripper arms and plate properly mounted.

### HAND POWERED TURRET PUNCH PRESS (See Figure 6-2)

Twelve and eighteen station punch presses, which enable punching of a wide variety of round or irregularly shaped holes (1/16 inch to 2 inches in diameter) in sheet metal with quick indexing turrets, are commercially available. Excellent tolerances can be maintained because of the positive alignment of punches and dies. Burr-free holes can be punched in the thinnest of materials. The turrets can either rotate independently or simultaneously depending upon the model and the manufacturer. In the operation of the independent rotating punch turrets and die turrets, the individual stations are numerically marked or lettered to prevent misalignment. A disadvantage of the turret type punch press is that only a limited number of punches and dies are available and there is no easy provision for adding a size different from one already mounted in the press at the factory.

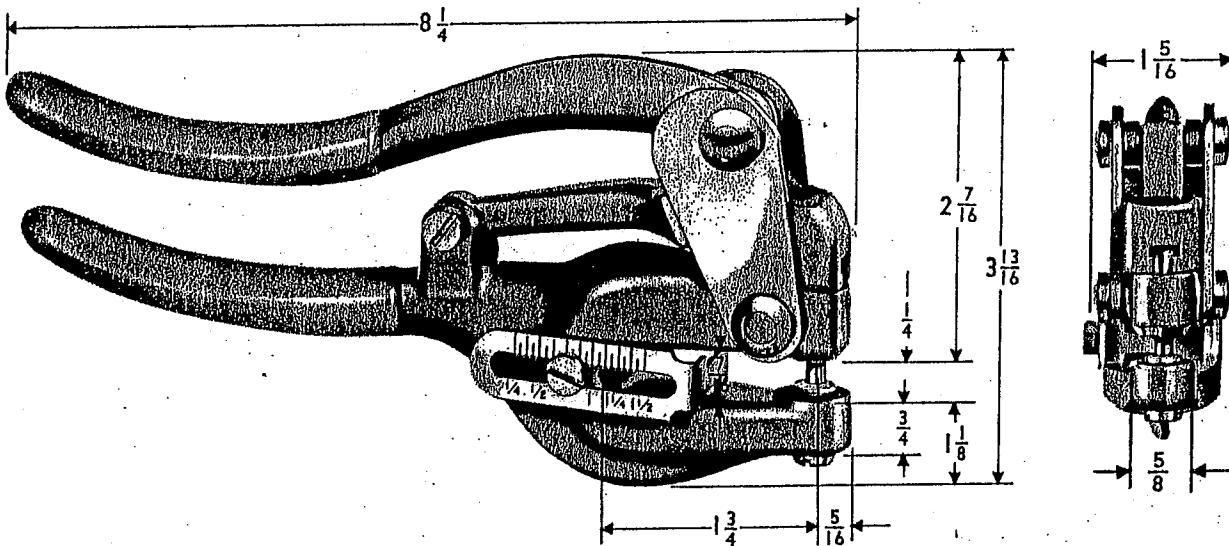


FIGURE 6-3: Roper Whitney No. 5 Jr. Hand Punch  
Courtesy of Roper Whitney, Inc.

### ROPER WHITNEY NO. 5 JR. HAND PUNCH

The Roper Whitney No. 5 Jr. Hand Punch, shown in Figure 6-3, is capable of punching 16 gauge aluminum without difficulty. It is capable of handling round punches and dies or irregular shaped punches and dies.

# SOLDERING

## GENERAL DISCUSSION

Solder is used to hold electronic components and wires together and it helps to insure a low resistance electrical connection. Basically, solder exists in one of two different states — a solid or a liquid. The only thing that makes a difference as to which of these states occur is heat. Most solder used in electronics is made up of a mixture of tin and lead. These two elements can exist in any number of percentage combinations. The combination of 60% tin and 40% lead is generally the most common solder used. It is designated 60/40 type solder.

Along with the tin and lead in solder is a rosin core which is called flux. The purpose of the flux is to clean the metal being soldered so that the solder will "wet" the copper wire or leads. The rosin flux removes the oxides that may already exist on the wires being joined together, and it permits a good bond to form after the solder solidifies — thereby providing a good electrical low resistance connection.

**NOTE:** Always make a strong mechanical connection before soldering. Do not depend on solder for all of the mechanical strength.

At times during the cooling process, after the heat is removed and the solder solidifies, the rosin hardens between the solder and wire. This causes a "rosin joint" which has neither a good bond or electrical conductive properties. Care must be used to make sure that this does not occur. It can generally be prevented by applying enough heat during the actual soldering operation and by careful inspection of the soldered joint after cooling. Many a radio or TV set has caused its owner discomfort and mental anguish because of intermittent or inconsistent operation due to a "rosin joint" which occurred during assembly or by an improperly solder joint following repair.

Another type of solder that finds use in the sheet metal and plumbing areas is acid core solder. This type of solder is never used in electrical or electronic type work because of its very corrosive properties.

It is a very interesting fact that, while tin melts at 450°F and lead melts at 621°F, together in a 60/40 combination they change state at 361°F — which is lower than either melting point considered separately. This temperature point (361°F), at which the 60/40 solder mixture changes from solid to liquid as heat is applied, is called the "eutectic point". With other percentages of tin and lead there is a pasty appearance to the solder between the solid and liquid state as it gradually melts with the application of heat. With the 60/40 combination of tin and lead the eutectic alloy is achieved which gives very little paste type action but mainly solid or liquid states.

For some electronic temperature sensitive applications, solder with small amounts of silver (1% to 3%) is used. This small addition of silver allows for an even lower melting point. Also, since silver has better conductive properties than tin and lead, it aids in lowering the resistivity of the soldered joint.

When insufficient heat is applied during the soldering process, the solder ends up pasty rather than in a completely liquid state. Upon solidifying during cooling, a "cold soldered" joint is created. This is a undesirable condition that must not be permitted to occur because it gives rise to a weak mechanical connection with very poor electrical properties.

Another type of joint that occurs is a crystallized solder joint. This is caused when the object being soldered is moved during the cooling (solidifying part) of the soldering process. The soldered joint gives a dull appearance which has a crystalline structure.

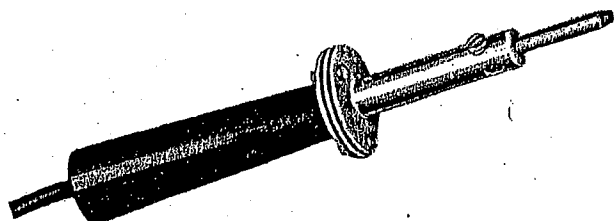
## SOLDERING IRONS (See Figure 14-1)

Soldering irons are manufactured with many different wattage ratings. Their function is to get hot enough to heat the elements that are to be soldered together, to melt and not splatter the solder, and to provide a nice even and smooth covering of the items to be soldered together at the soldered joint. It is absolutely necessary that the tip of the soldering iron is clean and free from oxides or rosins.

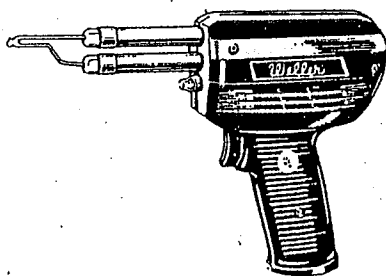
A simple procedure for cleaning a soldering iron tip is by filing. The soldering iron is plugged into an

appropriate power source and heated to its operating temperature. Then, it is ready for filing and the undesirable coating is removed. Also, pitted areas can be smoothed by filing. The next step is to coat the copper tip with solder. This can be done by simply dipping the tip in a solder pot or by using solder from a spool. The tip is then wiped clean with a damp sponge or cloth. This process is called "tinning" the iron. The soldering iron is now ready to use for soldering.

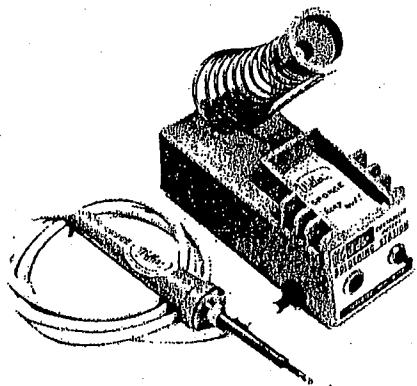
**NOTE:** Some soldering iron tips have a special plating on them and should **never** be filed.



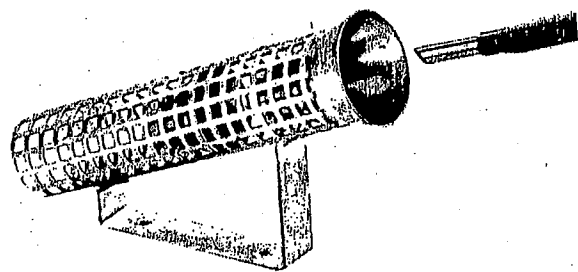
Wassco® Low Wattage Soldering Iron



Weller Hand Soldering Gun



Weller Low Voltage Controlled Output Soldering Station



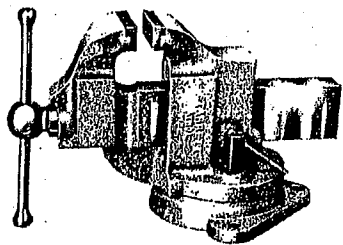
Adcola Soldering Iron Holder

**FIGURE 14-1: Soldering Irons and Holder**

### SOLDERING PROCEDURE

Prior to actual soldering, the element and wire to be soldered are first cleaned — either by scraping with a knife blade or by other appropriate means. Also, a chemical cleaner such as isopropyl alcohol can be used with a cloth to remove dirt, oil, rosin residues, etc. Then, the leads are "pre-tinned". This is done by wetting a wire with solder prior to soldering it into place.

The component lead or wire is then mechanically interconnected to provide some structural rigidity so the hands are free to hold the soldering iron and solder. At times, a mechanical vise, such as that shown in Figure 14-2, is used to provide a "third hand".



**FIGURE 14-2: Starrett Vise**

In order to provide good heat conduction from the soldering iron tip, melt a glob of solder on the tip of the soldering iron. Then, when the soldering iron is placed immediately adjacent to the point being soldered, the molten solder aids in conducting the heat to that area. Next, apply the solder to the elements being soldered so that they, and not the tip of the soldering iron, melt the solder. In other words,

let the tip of the iron touch the wires and then, on the opposite side of the wires, apply the solder so that it melts from the heat conducted through the wires. Another important point to remember, in order to insure a clean, neat, and shining soldered area, is to remove the soldering iron tip a split instant before removing the solder. With a little practice, this will become second nature to the accomplished solderer with correspondingly excellent soldering results.

Extreme care must be exercised to make sure that an excess amount of heat is not employed to damage or destroy the components being soldered. Many times the insulation of the wires is melted or burned giving an unsightly joint. The use of a heat sink and a good "feel" for the amount of time to permit the soldering iron to be applied to the soldered joint comes with practice.

When a soldering iron has not been used for several minutes, it is desirable to wipe the tip clean with a damp sponge or cloth. This will restore a bright shiny tinned surface to the tip. Wetting of the tip with a small amount of solder prior to touching to the desired solder joint will again insure good soldering action. Removal of residue or rosin, after a joint has been soldered, can be effected by using isopropyl alcohol.

Do not leave a soldering iron plugged in, when not using it, unless it is on a regulator. Otherwise, it will overheat and the tip will overoxidize and become pitted or damaged.

**NOTE:** Never strip wire insulation with a diagonal cutter because it can nick the wire and the wire breaks very easily at the point where it has been nicked. This is especially true for solid wire.

## SPECIAL TOOLS

**WIRE STRIPPERS:** Wire strippers are used to remove insulation from wire. There are several types that are commercially available. Three of these types are:

1. The Miller wire stripper, shown in Figure 14-3(a), is one of the most commonly used and available wire stripper and cutter. This particular model consists of smooth cutting five inch blades which make stripping and cutting of up to No. 8 solid or stranded wire easy and quick. It is possible to "nick" the wire while stripping with this particular tool, so it should be used with extreme care. However, Miller has other models of this tool. One has an extruded cam and the other has a calibrated dial to hold the jaws to the exact wire size for comparatively no-nick wire stripping.



FIGURE 14-3(a) Miller Wire Stripper

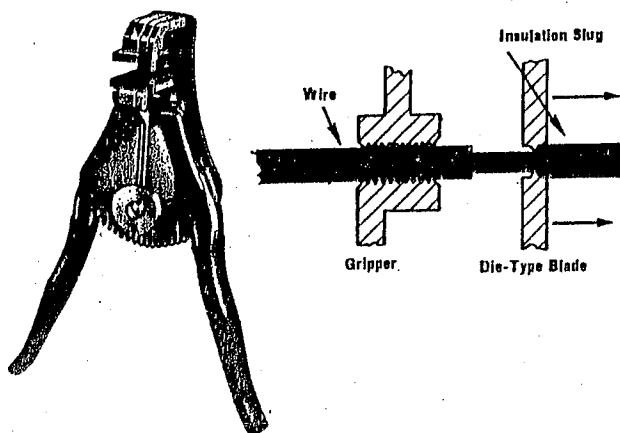


FIGURE 14-3(b): Stripmaster® Wire Stripper

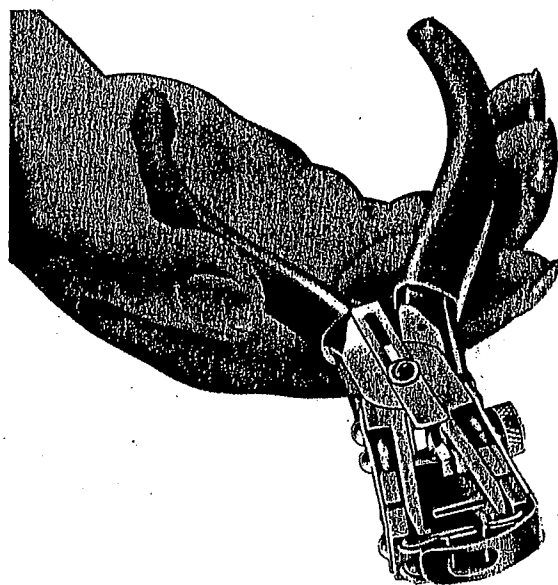


FIGURE 14-3(c): Pioneer Thermal Wire Stripper

2. Automatic single squeeze wire strippers, such as that shown in Figure 14-3(b), practically eliminates nicking and cutting of wire, and it won't crush the wire or fray the ends of the insulation. It can strip up to 7/8 inch wire with one light squeeze of the contoured handles. The jaws stay open after stripping off the

insulation to allow the removal of the wire before the blades snap back. It can easily handle 12 to 24 gauge wire.

3. Thermal Strippers, such as that shown in Figure 14-3(c), use a hot wire to strip the insulation from the wires. With this type of stripper there is no way of cutting or nicking the wires, but it is limited to insulation that will melt.

**SOLDERING AIDS:** Soldering aids are small elongated tools that aid in soldering. The top three, in Figure 14-4, have one forked end that straddles the wire and with a slight twist, grips it for easy unwinding and removal, or guides it into another lug for soldering. The curved end on the soldering aid can be used as a scribe or as a circuit tracer when looking for loose connections. The second aid down has a spade end that is used as a reamer to clean lug holes. The bottom two have wire brush ends for cleaning connections before soldering, brushing out splattered solder, and in repairing P.C. boards. The bottom aid also has a knife end for cutting and repairing P.C. boards.

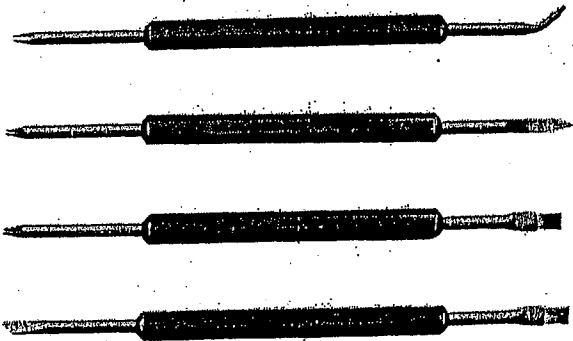
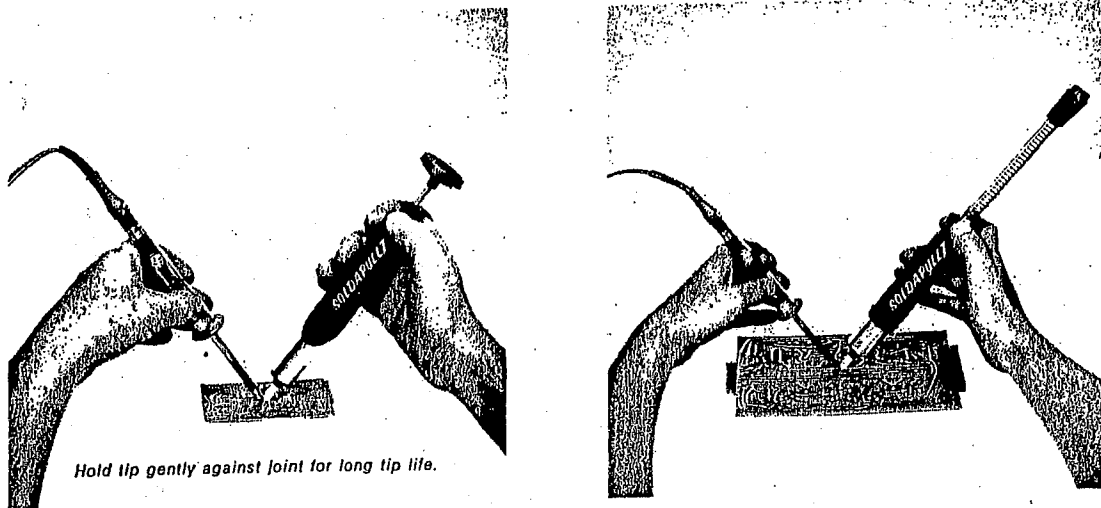


FIGURE 14-4: Norseman Soldering Aids

**SOLDER PULLER:** The solder puller, such as the one shown in Figure 14-5, has a triggered sliding plunger which creates a vacuum suction when triggered. It is used in desoldering by "cocking" the vacuum plunger, melting the solder around the soldered point with a hot iron, and then placing the tip of the solder puller against the molten solder and pushing the trigger. The vacuum suction created removes the molten solder very effectively.



WARNING: Keep clear of knob during vacuum stroke, also do not leave SOLDAPULLT loaded when not in use.

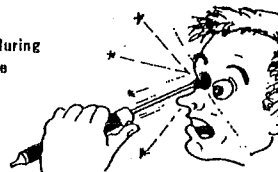
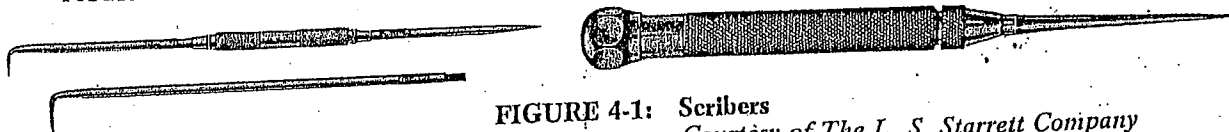


FIGURE 14-5: Soldapull® Desoldering Tool

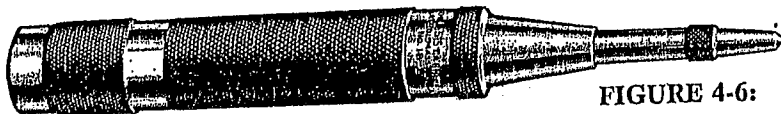


Other Equipment Used

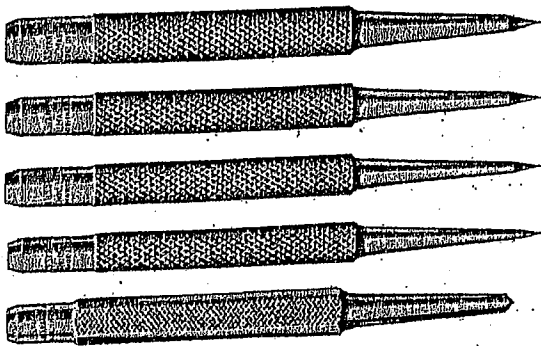
Metal layout consists of making the lines that exist on a drawing appear on metal at precisely the correct places. The metal is marked by means of a tool called a scribe (see figure below). It is very important that the markings of the layout on the metal are exact since a small mistake means that the work will be cut or bent at the wrong places and will result in waste of both time and material.



**FIGURE 4-1: Scribes**  
*Courtesy of The L. S. Starrett Company*

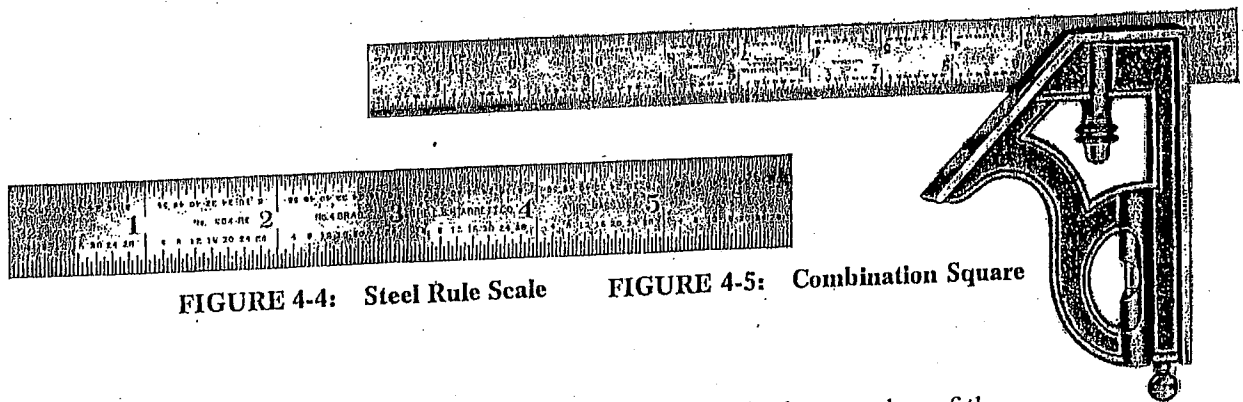


**FIGURE 4-6: Automatic Punch**  
*Courtesy of The L.S. Starrett Company*



**FIGURE 4-3: Center Punches**

The center punch is used to locate the center mark for a hole that is made in the metal. The steel ruler and combination square are the advisable tools to transfer measurements to metal.



**FIGURE 4-4: Steel Rule Scale**

**FIGURE 4-5: Combination Square**

Note: When scribing, slant the scribe so that it follows the lower edge of the combination square. Make measurements starting from the inch mark on the rule, rather than from the beginning of the rule, because the end of the rule may be worn or bent.

## EM 130 LAB - TOOL SKILLS

### PROJECT #1: MEASUREMENT

Performance Span: 1 Session (Complete at home if necessary)

#### Materials Required:

6" Steel Ruler

#### Assignment:

1. Complete the measurement exercise in Figure 1-1 on STF-5 using the scale on the paper, then submit your sheet for grading.
2. Using your 6" steel rule complete the Text Book measurement exercise in Figure 1-2 on page STF-6 and submit your sheet.

## Project # 2: Wiring Exercise

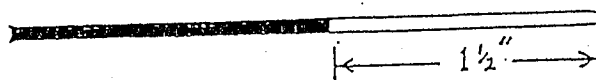
Performance Span : 1 session (Complete at home if necessary)

The Materials Required for this Experiment will be given to you by the technician.

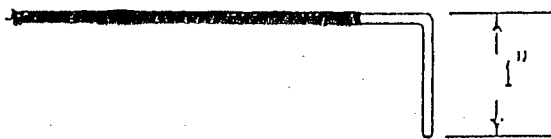
Quantity	Materials Required
1	9 inch length of 22 gauge stranded wire
1	3 inch length "zip cord"
1	6 inch length # 16 magnet wire (solid)
1	Spade terminal

### Magnet Wire

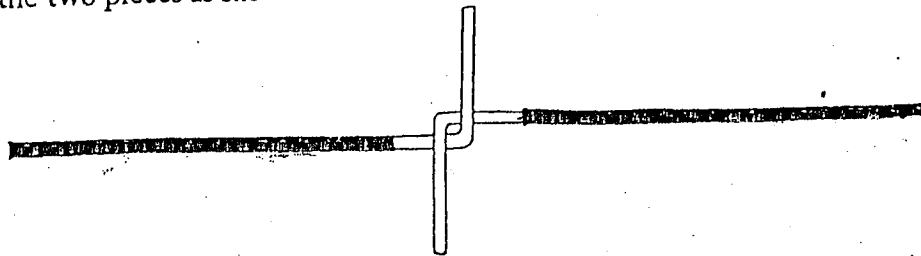
1. Cut the solid enameled magnet wire in half so that you have two, 3 inch pieces .
2. Now scrape the enamel insulation from ONE end of each piece, back a distance of  $1\frac{1}{2}$  " .



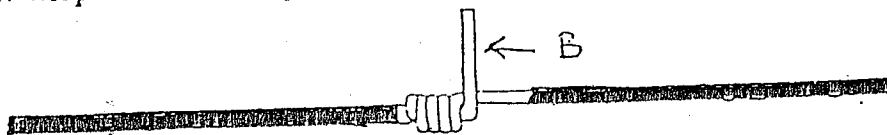
3. Be Sure All Enamel is Removed, otherwise you will have a poor solder joint.
4. Bend the cleaned end at right angles, 1 inch back from the end on both pieces.



5. Place the two pieces as shown.



6. Now wrap the end of one piece around the body of the other piece, neatly and tightly.



Note : Wrapped areas must be clean and enamel free.

- Repeat step # 6 with the remaining end. B (see step # 6) The soldering iron must be kept clean and covered with melted solder or tinned. Keep the tip clean and tinned or it will oxidize and transfer heat poorly. Also make sure the tip stays tightly fastened to the soldering iron. Dip the hot iron in flux. Then put solder on the tip-tinning the iron.



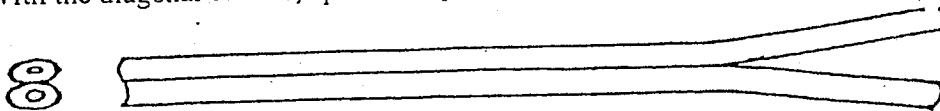
- Using a tinned soldering iron, apply heat to the side of the wraps and apply the solder to the opposite side of the iron. When the wire is heated to the proper temperature, the solder will melt and run ( Flow ) around the wrapped section.

**DO NOT APPLY THE SOLDER DIRECTLY TO THE SOLDERING IRON TIP.**

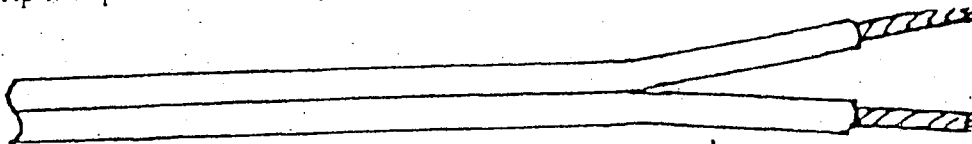


#### Zip Cord Wire

- With the diagonal cutters, split the zip cord apart a distance of  $1 \frac{1}{2}$  ".



- Set your wire strippers to a size slightly larger than the conductive wire in the Zip Cord
- Strip the split ends of the Zip Cord back  $\frac{3}{8}$ " from the end.



#### NOTE:

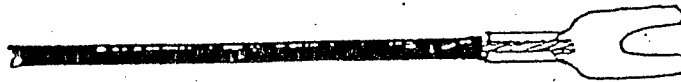
If the wire stripper does not cut through the insulation, adjust the hole slightly smaller, until all the insulation is cut but **NOT THE CONDUCTORS.**

**DO NOT NICK OR CUT THE CONDUCTOR STRANDS - THE CONDUCTOR WILL TEND TO BREAK AT THE NICK LATER. IF THIS HAPPENS, CUT OFF THE CONDUCTOR AT THE NICK AND RE-STRIP.**

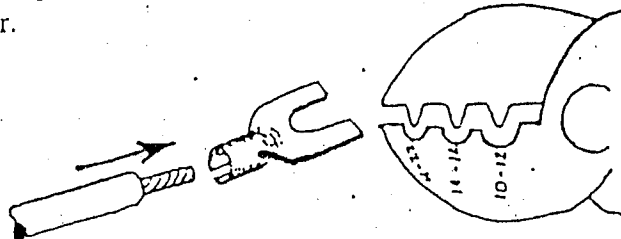
4. Holding the Zip Cord in one hand, gently twist the conductor strands until smooth and tight. Do both stripped ends.
5. Apply the soldering iron to one side of the twisted conductor, the solder to the opposite side and let the solder flow until a thin silver coating covers the conductor wire. Be careful not to put too much solder on the conductor.
6. This operation is called TINNING, it prevents loose strands and improves the soldering joints when the wire is connected to a terminal.

### Stranded Single Conductor

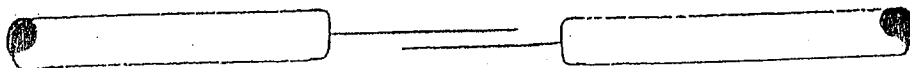
- 1). Cut the 9" piece of strand wire into 3 pieces. Strip one length back 5/16" and twist.
- 2). Slip the spade connector over the twisted conductor until the conductor is FLUSH with the end of the sleeve.



- 3). Obtain the proper Crimping Tool for Spade connectors from the Instructor or CLT.
- 4). Open the tool's jaws and lay the spade sleeve in the half round opening which best fits the sleeve. The SPLIT on the spade sleeve faces DOWN in the tool. Center the sleeve and pliers and squeeze hard on the handles. The crimp should be tight enough to hold the conductor.



- 5). Now with the last two pieces of wire, strip the insulation back 1/8 of an inch on the end of each piece. Lay these two pieces side by side with one extending away from it's mate as shown below and solder the two pieces together without twisting them.



You have now completed the Wiring Exercise. Place all the finished connections back in the envelope, and submit to the Instructor for grading.

STUDENTS SHOULD NOW SIGN THE SAFETY AGREEMENT STAFF WILL DISTRIBUTE STF-7

## SHEET METAL BOX FOR DIGITAL TRAINER

Performance span on sheet metal : 3 weeks.

### MATERIALS REQUIRED :

( These will be given to you by the Lab. Technician. )

1 Piece of sheet steel for (Bottom) 11 7/8" x 8"

1 Piece of sheet steel for (Top) 13 1/16" x 8"

### \*\*\*\*\* Important Notes \*\*\*\*\*

- 1) Make Sure that you know how to use all equipment in the Lab.  
If you were absent when use of the equipment was explained,  
**ASK the Professor or Technician For Help** .

### **SAFETY IN THE LAB IS VERY IMPORTANT**

- A) Drawings are not to scale!
- B) All **Metal Sheets** that you receive should be checked for squareness.  
Use a **COMBINATION SQUARE** from the stockroom. If metal is not square,  
square it on the shear and cut to size.
- C) All Metal should be **DE-GREASED** before painting by **SANDING** .

## BOTTOM SECTION of Digital Trainer

Performance Span : 1 Session

### MATERIALS REQUIRED :

1 PIECE OF SHEET STEEL - SIZE:  $11\frac{7}{8}$ " x 8"

### The Layout

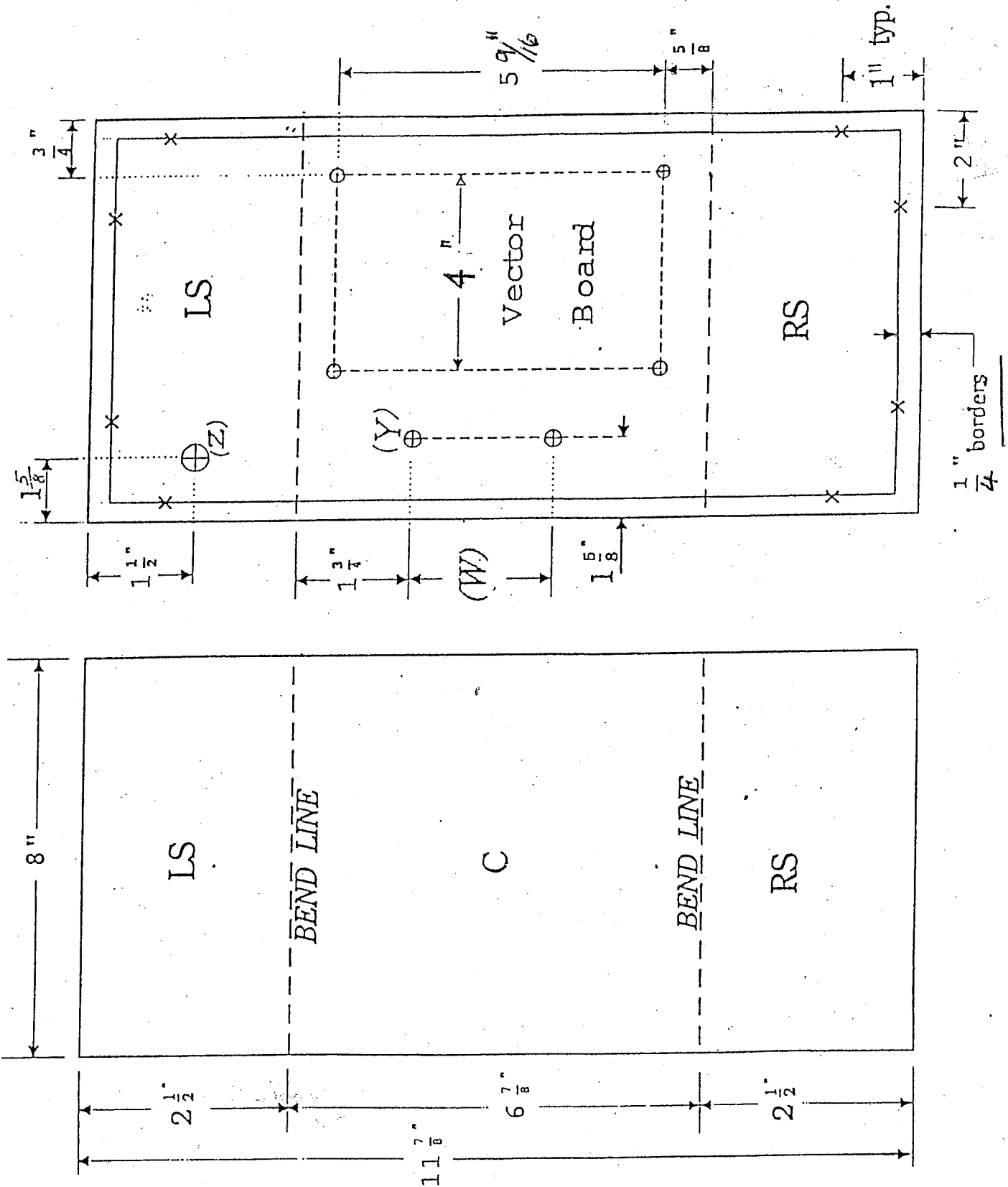
1. Ask the technician for a piece of sheet metal which should be approximately  $11\frac{7}{8}$ " x 8".
2. Check metal sheet for size and squareness. If incorrect, then measure and cut to correct size on the shear.
3. Measure and scribe bend lines on **BOTH** sides of the sheet as shown in Fig. 3-1.
4. Next, mark 4 border lines (one side only) at  $\frac{1}{4}$ " from the edges of the metal sheet. On the borders, measure and scribe the 8 screw hole positions marked "X" on the drawing.
5. Next, measure and mark the 4 holes for the Vector Board.
6. Now mark the hole labeled "Y" on your drawing. This is the first hole for your Transformer. The distance "W" for the second hole depends on the Transformer you bought. You must now measure the width between your Transformer holes, then mark the second hole on the sheet metal.
7. Finally, scribe position "Z" for the Strain Relief hole.
8. Re-check your measurements, and **LIGHTLY** center-punch all hole positions, then have your layout checked by the **STAFF** BEFORE you punch the holes.
9. Use the "Turret Punch" to make the 8 screw holes (marked "X") on the drawing. The size of these holes should be  $\frac{1}{8}$ ". Then punch the 4 Vector Board holes with the  $\frac{1}{8}$ " punch also.
10. Make the 2 Transformer holes (marked "Y")  $\frac{3}{16}$ " in diameter.
11. For the holes marked "Z" measure the diameter of your Strain Relief if possible before punching (Some strain reliefs require a # 8 punch). Otherwise, simply punch a  $\frac{3}{8}$ " hole and ream it to the size later.
12. Turn the metal sheet over and File or hammer all burrs. A large drill bit also works well.
13. Now using the "Finger Brake" tool, bend the two sides 90 degrees at the lines marked "BEND LINE" on the REVERSE SIDE.

Have the bottom part of the box checked and graded, then you can take home and paint both sides.

UNIVERSITY OF CALIFORNIA

FIGURE 3-1

Layout for BOTTOM Section of Box





## TOP SECTION OF DIGITAL TRAINER

Performance Span: 2 sessions

### Material Required:

1 Piece of sheet metal – SIZE: 13 1/16" x 8"

### The Layout

1. Obtain a piece of metal for the Top layout – the size should be 13 1/16" x 8". If the metal is bigger, check for square-ness and then cut to size. Note: Have the Technician check your measurements before you cut.
  2. Scribe all bend lines on both sides of the metal as shown in Figure 4-1 and 4-2. Also scribe the lines for the four corner notches.
  3. For simplicity, let us label the three sections of the sheet metal -"R" REAR, "T" TOP, "F" FRONT. Scribe these letters in the appropriate spots in Fig: 4-1 and 4-2.
  4. On the FRONT and REAR sections, measure and mark one hole for each side as shown in Fig 4-2. On the TOP, measure and mark two holes on each side. These 8 holes are screw holes. Let the Technician or Instructor check these holes for accuracy.
  5. Lightly center-punch the 4 points where the four bend lines intersect each other and the 8 screw holes.
  6. If your center-punches are correct you may proceed to the turret punch. Punch the 4 point 1/8" in diameter. These are for making "relief" holes for the corner notches. Now, punch the 8 screw holes 3/16" in diameter.
  7. Use the Corner Notch machine to make four 90° notches at the relief holes as shown in Figure 4-2.
  8. Now start working on the 7" x 8 1/16" Top section marked "T". This section requires great care and accuracy in measuring due to the number of components being places here.
- \* Figure 4-3 is an enlarged view of the TOP section shown in Figure 4-2. (Between the 90° notches).
- \*Figure 4-5 shows how the "TOP" should look when it is completed with all the parts mounted.

9. Now carefully measured and scribe all holes positions on Top Panel using the measurements given in Fig 4-3.
10. Recheck you measurements and scribe lines, then have your worked checked by the technician before center-punching any holes.
11. If all of your measurement are correct, center-punch all holes. Then adjust the Turret Punch for the required size holes as below, and punch carefully. Unfortunately, it is difficult to purchase standard parts, so the sizes of some parts must be measured.

- \* Holes marked (E) - There are 3 sets of 10. For each set make the 2 **end** holes 1/8 “, and the inner 8 holes 3/16” in diameter.
- \* Holes marked (A) - There are 7 of these. Measure the diameter of your **L.E.D. Holders.**
- \* Holes marked (B) - There are 4 of these. Measure the diameter of your **Toggle Switches.**
- \* Holes marked (C) - There are 2 of these. Measure the diameter of your **Momentary Switches.**
- \* Holes marked (D) - There is only one. Measure the diameter of your **1 Meg. Potentiometer.**

\*\*\* Check that all components fit in their designated holes and make any needed adjustments before you file down all burrs. Have the last four digits of your ID # stamped on the “R” section of your metal.

12. You are now ready to bend the Top section. Take the Top layout and your manual over to the Finger Break tool. **BE SURE TO FOLLOW BEND LINES ON THE REVERSE SIDE OF THE METAL, AND BEND IN THE SAME SEQUENCE AS SHOWN IN FIGUR 4-4.** (All other markings are face down.)
13. Have the Top part of your box checked and graded, take it home and paint BOTH sides.

**NOTE:** Nothing will be graded from now on without this ID #. Make sure the painted metal is fully dried before placing all components on the Top Section.

You have now completed the metal housing for your Digital Trainer.  
Next you will work on the internal electronic section.

FIGURE 4-1

FIGURE 4-2

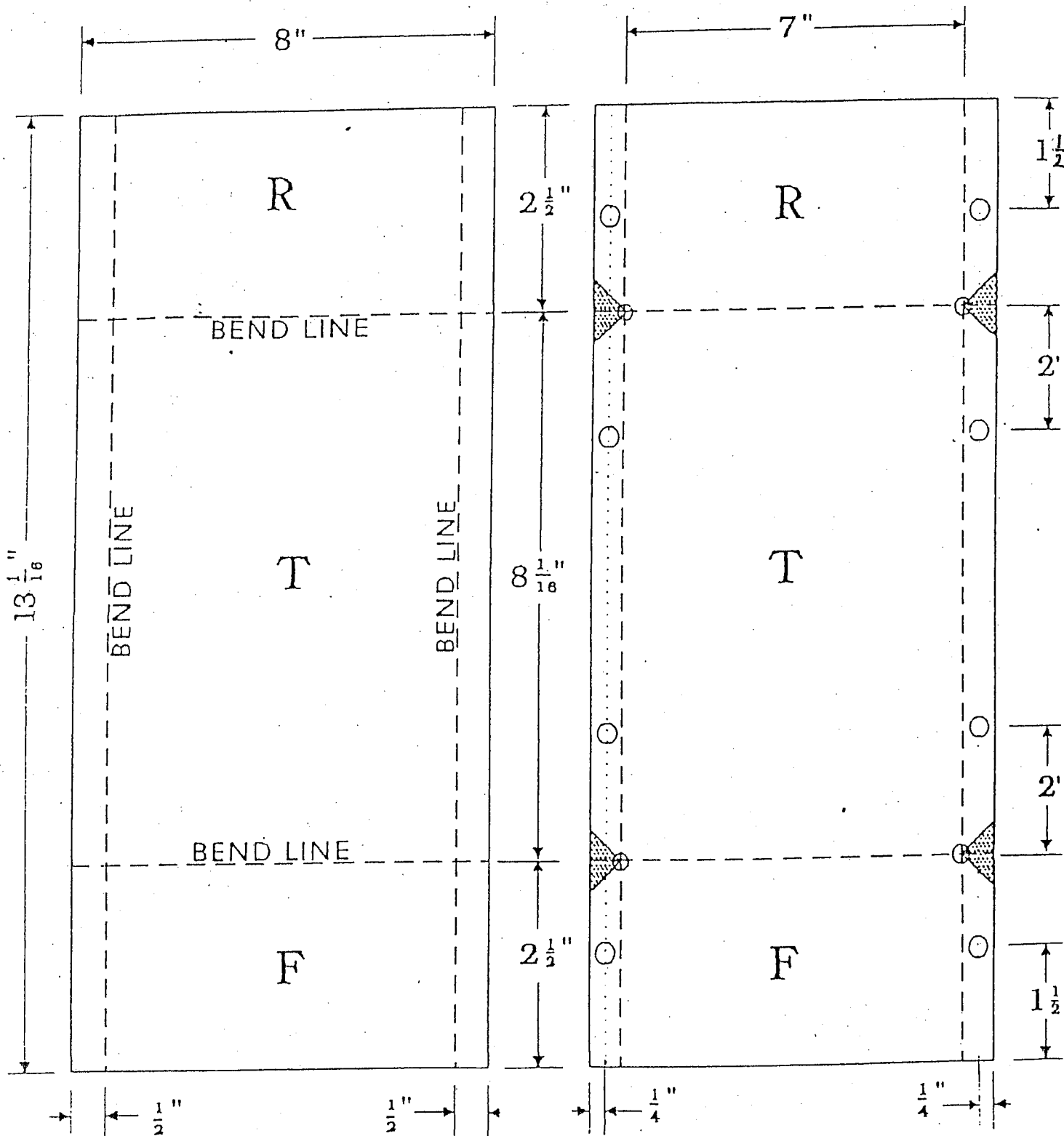
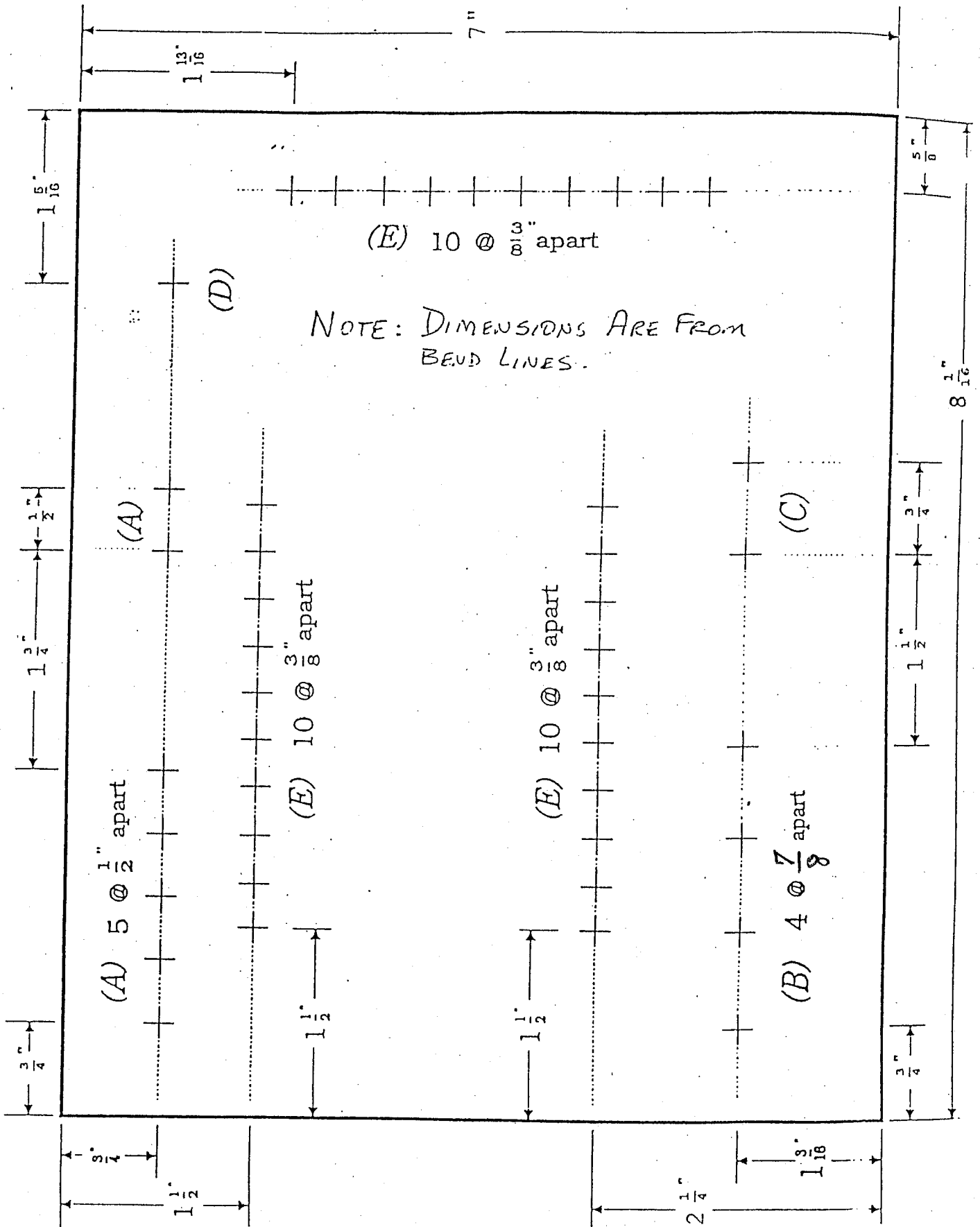
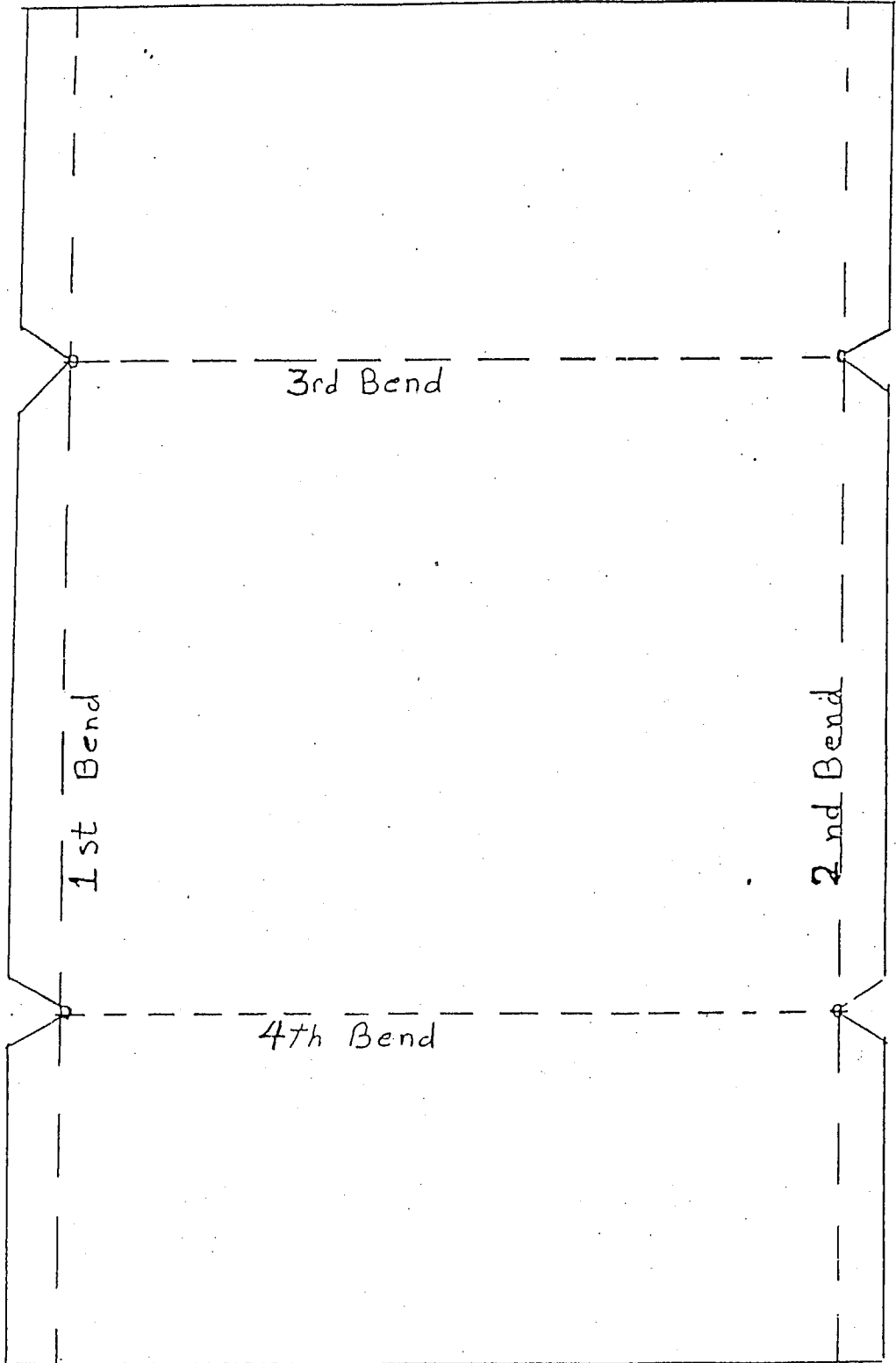
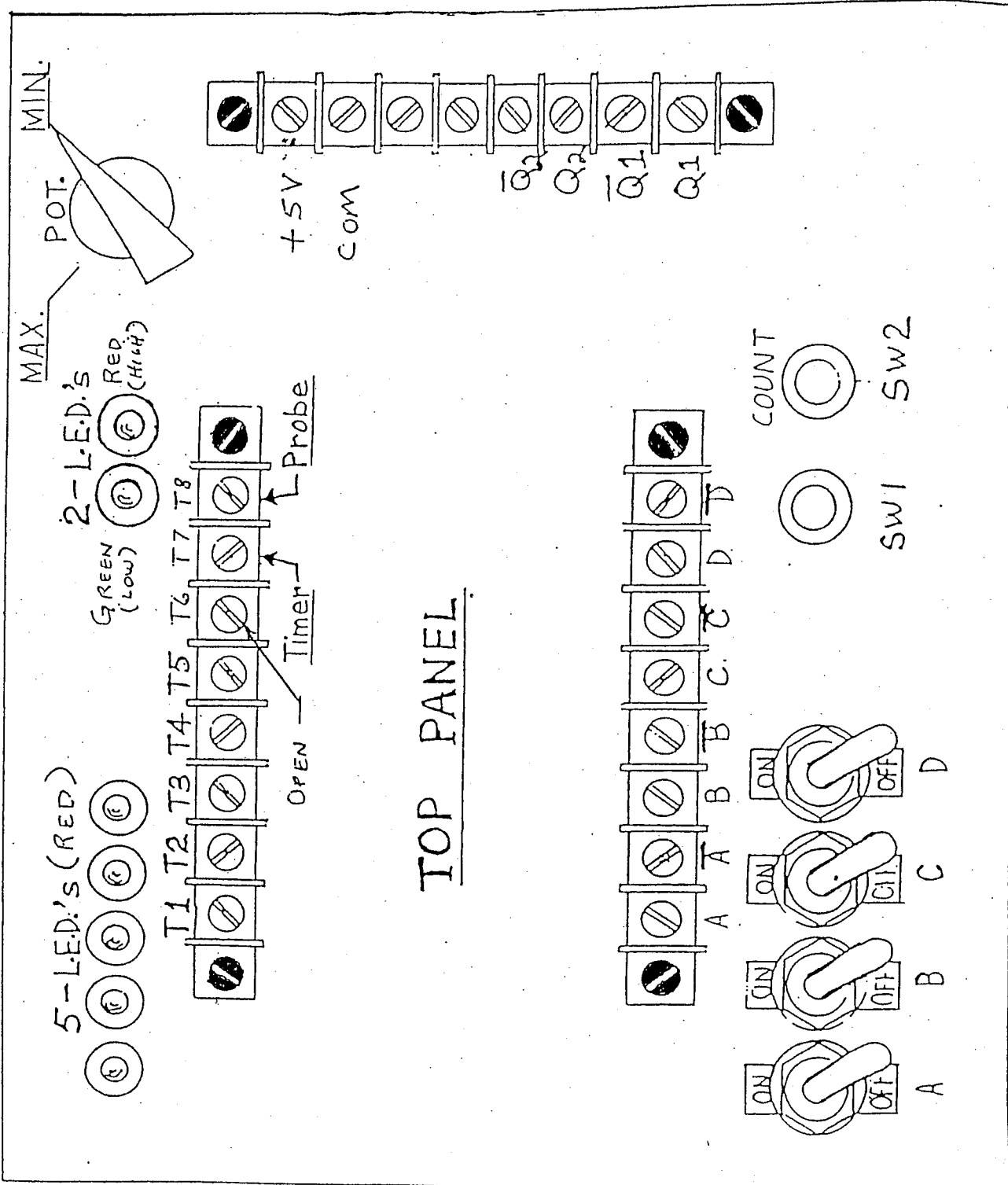


FIGURE 4-3



BEND SEQUENCE for Top Layout





TOP PANEL

## Printed Circuit Board Layout

### Materials

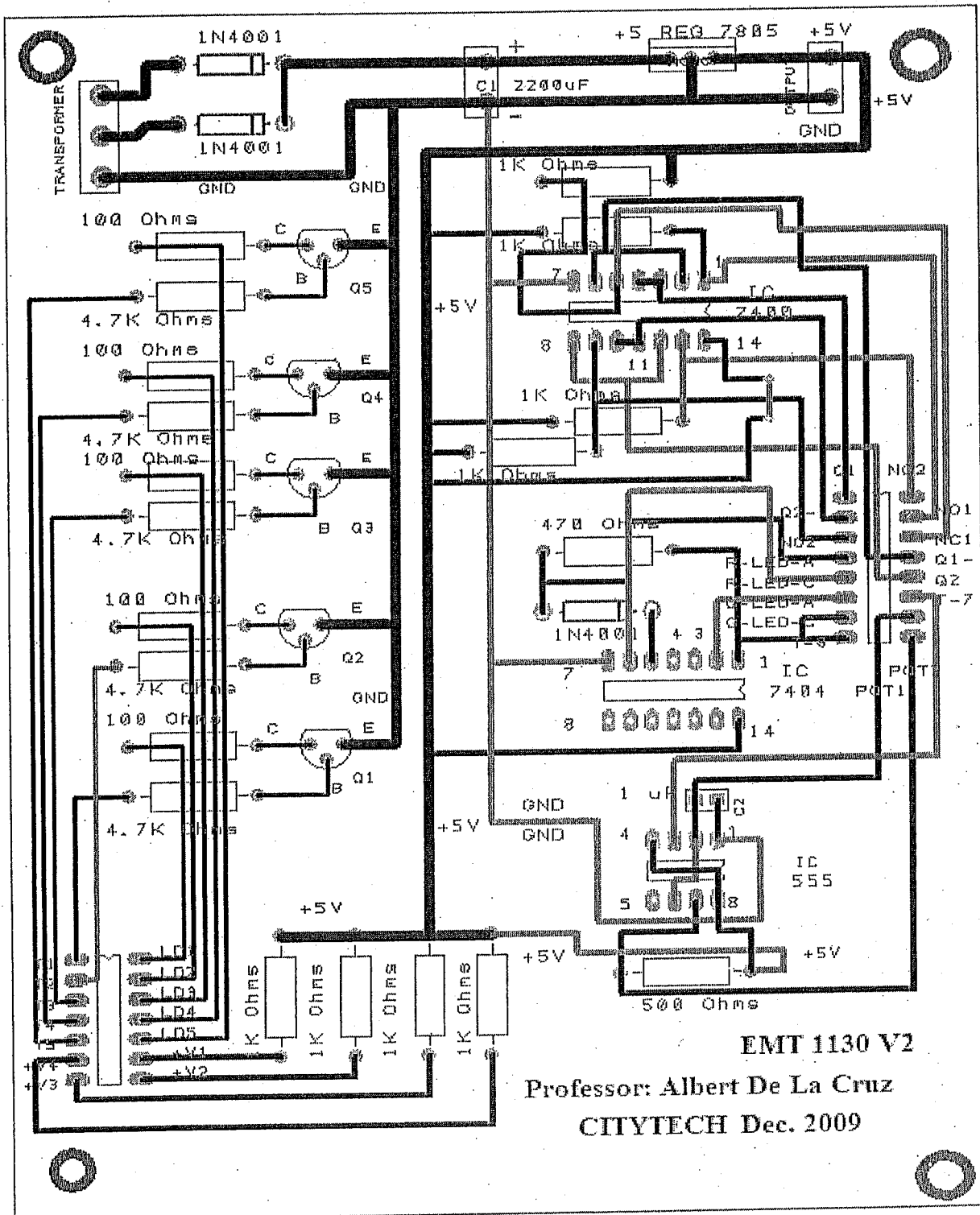
- 1 – Printed circuit board (PC board)
- 4 – PC board Stand-offs with (8) screws

### Mounting holes

1. Place the PC board (facing down) over the vector board section on bottom of the sheet metal.
2. Line up the vector board hole to the PC board, making sure that the holes are on the outer ends of the circuit.
3. Tape the PC board onto the bottom section. Have it checked by the CLT before drilling.
4. Next, use the drill press to drill four 1/8" holes at the point indicated.  
**(Note: Goggles must be worn when operating the drill press, use the wooden mat provided for drilling)**
5. Using the screws provided, fasten the four PC board stand-offs to the bottom of the PC board through the 4 holes drilled.
6. Now you can start placing the components on the PC board
7. Cut and crimp the wires to the connectors. Test each wire for continuity.
8. The wiring connection for each section on the PC board is covered in various topics eg. Power Supply, L.E.D Drivers etc.
9. After completion of each section have it test by the CLT or Professor. Correct any problems before moving on to the next section.

Printed Circuit board

Figure 5-2





## How to Crimp Cables

1. Before you begin you should prepare the parts needed to make your cable.
2. Cut the ribbon cable into the required lengths using the cutter provided or with a wire cutter.
3. Make sure that your crimping connectors are unsnapped and the teeth are exposed.
4. Insert the wire in the space between the teeth and the plastic housing.
5. Align the end of the cable so that it is flush with the housing (protruding slightly).
6. Insert the teeth of the connector with the cable in the jaws of the crimping vice.
7. Gently but firmly turn the handle on the vice to apply pressure until the snaps on each end of the connector has closed.
8. Strip the ends of the wires on the other end of the ribbon cable. Use a multi-meter to test for continuity from the pins of the connector to strip ends of the cable.
9. Set the meter to the Ohms' scale ( $\Omega$ ). When testing the cable, the meter should read zero (not flashing) or close to zero (depending on the type of meter you might hear a sound) if you have continuity.
10. If there is no continuity you may have to re-crimp the cable. Have the professor of CLT check the connections before you re-crimp.

## POWER SUPPLY CIRCUIT

Performance Span: 1 Sessions (complete at home if necessary)

### Overview:

You are now wiring the power supply which will power the L.E.D's, transistors and IC-chips in your Digital Trainer. This Power Supply Circuit is used to convert the 115VAC line voltage to a small DC voltage capable of powering the semiconductors you will use. Refer to Figure 6-1, page 42.

- The TRANSFORMER steps down the line voltage -115 volts (AC) to approximately 13 volts (AC)
- The RECTIFIER (which consists of 2 diodes) converts AC voltage to DC voltage.
- The CAPACITOR filters the pulsating DC, and reduces any voltage variations.
- The VOLTAGE REGULATOR then maintains a DC output voltage at a constant 5-volts level. Without this regulator, a heavy load (demands for more current) would cause the voltage to drop and pulsate drastically.

### Materials Required:

Pictorial of components

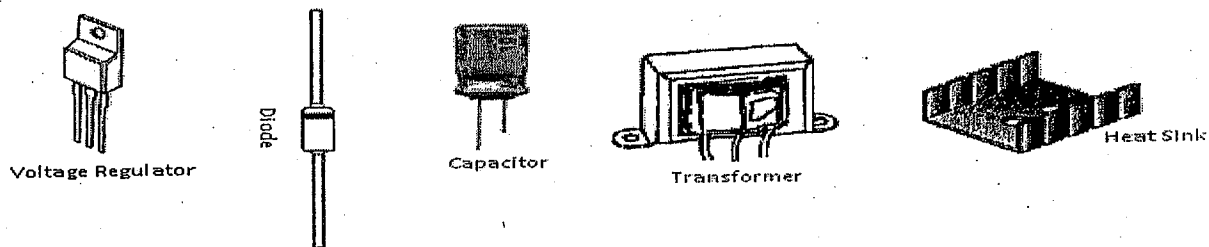


Figure 6-1

### Wiring the circuit:

- Using the layout on the PC board, place all components on their respective positions and solder all connection on the opposite side of the PC board as shown in figure 6-2

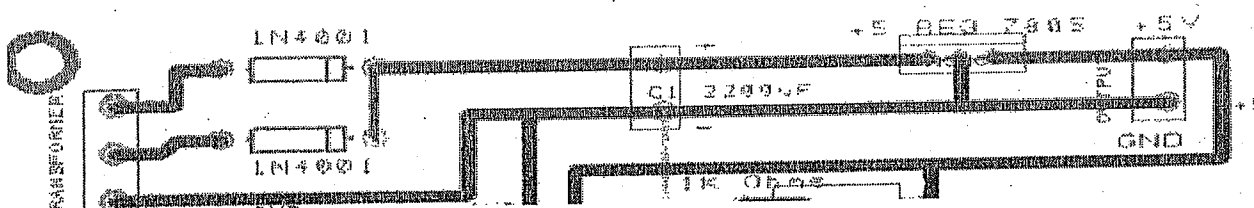


Figure 6-2

**Note: IT IS IMPORTANT THAT YOU OBSERVE CORRECT POLARITY WHEN CONNECTING THESE COMPONENTS.** The large capacitor minus sign polarity is marked on the side of the capacitor.

2. The Outputs from your power supply (+5 V and Common) must be connected to top of the digital trainer as shown in Figure 4-5 on pg 36. Use red wire for positive (+5) and black wire for negative/common.
3. Place the metal Heat Sink on the 7805 Regulator, and then solder all connections properly.
4. Next, mount the Transformer inside the Bottom part of your metal box with two screws and nuts.
5. Place the Strain Relief over the line-cord about 3" from the end, and squeeze with pliers. Insert line-cord with strain relief into the hole on the rear of the Bottom part so that there is a tight fit. (See Figure 6-4, page 43)
6. Now strip 3/8" off the GREEN wire from the line-cord, and attach the spade terminal using the correct crimping tool. Secure the spade under one of the transformer mounting screws. (See Figure 6-4)
7. Strip 3/8" off the two remaining wires of the line-cord, slip two pieces of heat shrink tubing over them, then twist and solder them to the two primary wires of the Transformer. If you are not sure which wires are primary, ASK THE TECHNICIAN. Be sure to shrink the tubing over the joints after soldering.
8. Finally, solder the two Secondary wires of the Transformer to the rectifier Diodes as indicated in Figure 6-2, page 40.
9. Trim all protruding wires.

Your Power Supply Circuit should now be complete.

**DO NOT PLUG IT INTO THE OUTLET.**

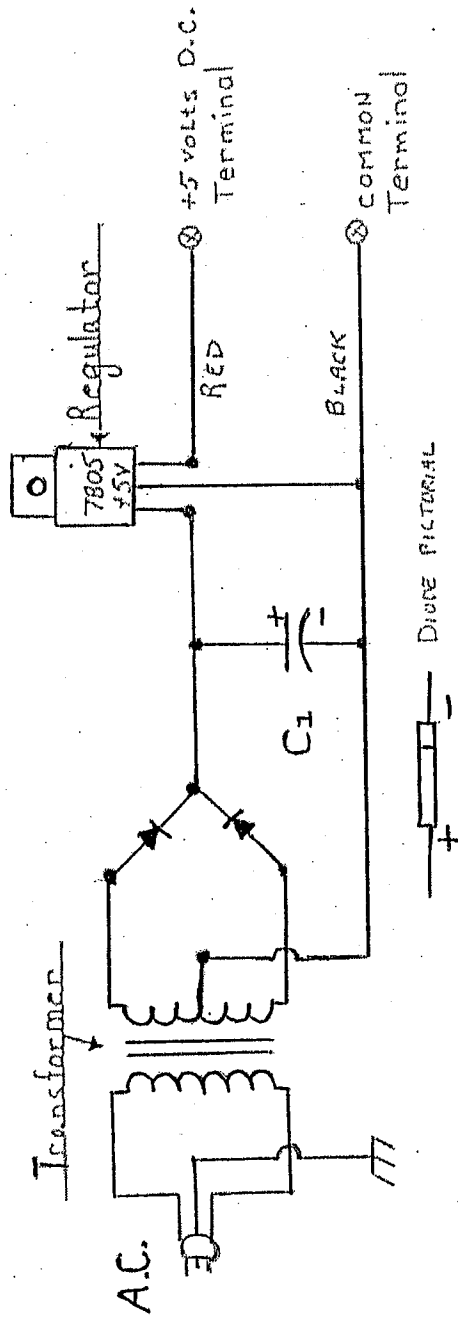
Ask the Technician to check it first, then have your

Power Supply graded if it works properly.

FIGURE 6-2

The Power Supply Circuit

Schematic



DIODE SYMBOLIC



NOTE: BAND ON NEGATIVE POLE (CATHODE).

Block Diagram

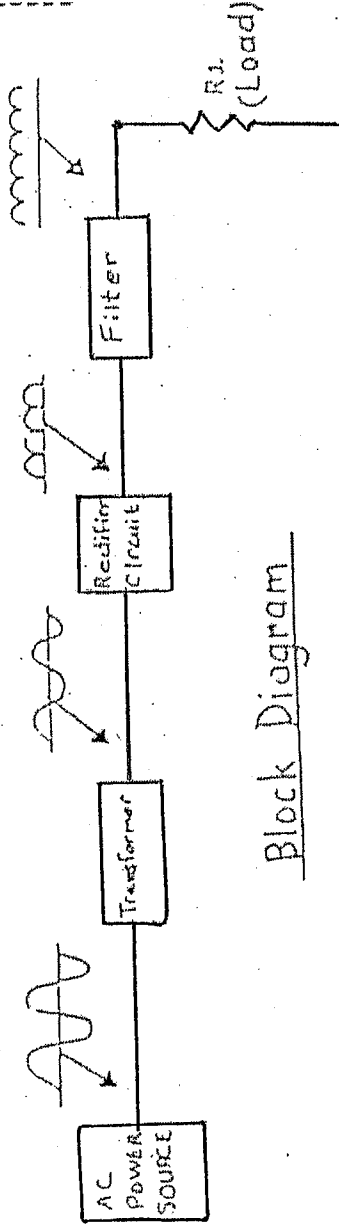
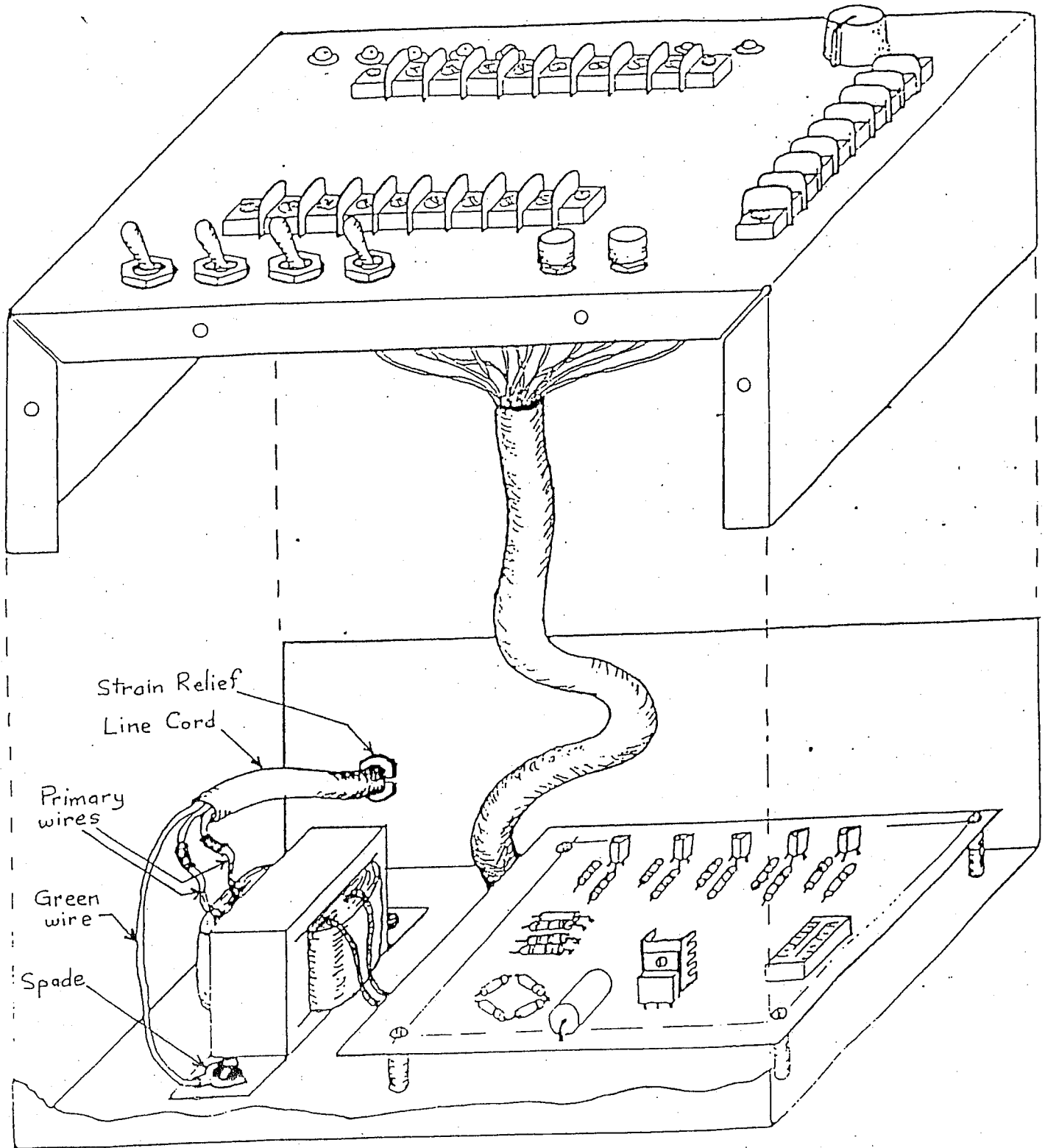


FIGURE 6-4

EXPLODED VIEW OF THE FINISHED PRODUCT.



## The LIGHT EMITTING DIODE (L.E.D) Circuit

Performance Span: 1 Session (complete at home if necessary)

### Materials Required:

- 5 -100 $\Omega$  resistors
- 5 – 4.7K $\Omega$  resistors (4700)
- 5 - NPN transistors
- 5 - L.E.D's
- 5 - L.E.D. Holders
- 1- 14pin socket
- 1- Dip pin connector with ribbon cable

**Note: Resistor color code is on page 62.**

### (A) The LED's

#### Overview:

L.E.D's (Light Emitting Diodes) are a special type of diode which emit light when a voltage is applied across the anode and cathode.

Fig. 7-1 (page 47) shows the schematic diagram and some typical configurations for Light Emitting Diodes.

#### Wiring:

1. Figure 4-5 (page 36) shows the position for the 5-L.E.D's on the top of your box. Insert the L.E.D's holder from the top, then insert the L.E.D's into the black material from the holder, place the material with the L.E.D's into the holders from the bottom.
2. Next, determine which type of L.E.D's you have from Fig. 7-1, then solder the 5 Anodes together as shown in figure 7-3 (page 48) then use a long RED wire (approx: 18") to connect these anodes to the +5 volt terminal on the top of the box marked +5 (see page 36).

Leave the 5 cathodes (LD1 - LD5) alone for now.

## The LIGHT EMITTING DIODE (L.E.D) Circuit (Cont'd)

### (B) The L.E.D. Drivers

#### Overview:

The L.E.D. Drivers are Transistors Q1 - Q5 which act like switches to turn the L.E.D's ON and OFF. (see the analogy in Fig. 7-2, page 47)

Now look at Fig: 7-4 (page 48) When a voltage is applied to the base of the transistor through terminals T1- T5, the "switch" closes the circuit from collector to emitter. This enables a voltage across the L.E.D, which then emits light. The 4.7K $\Omega$  resistor limits the base current so that the transistor does not burn out. The 100 $\Omega$  resistor protects the L.E.D by limiting the current through it.

Wiring: Follow the PC board layout in figure 7-5. (page 46)

Layout all components, then set up one set of drivers (1-transistor, 1-100 $\Omega$  and 1-4.7K $\Omega$  resistor). Have the connections checked by the technician **before** soldering any joints.

1. Determine which type of transistor configuration you are using from fig. 7-2 (Page 47). Locate the Emitter (**E**), Collector (**C**) and Base (**B**) pins on the transistor. Note that the emitters are connected together on the PC board.
2. Place the transistor in the correct position on the PC board.
3. For each transistor, connect one end of the 100 $\Omega$  resistor to the **collector**.
4. For each transistor, connect one end of the 4.7K $\Omega$  resistor to the **base**.
5. Have the circuit checked, and then solder all joints properly. Trim all protruding wires. Now you can complete the other four sets.
6. Place the 14-pin socket on the PC board; note that the notches on the PC board and socket indicated the placement position. Solder all pins of the socket to the board.
7. Insert the dip pin connector with cable in the 14-pin socket. The ribbon cable connection is as follows, starting from the notch 14, 1,13,2,12,3 etc. See pg 52 for socket pin layout. Note that the socket layout and the ribbon cable layout is different.

8. Using the labeling on the PC board, locate all cables for this circuit : T1 –T5 and LD1 – LD5, connect the wires to their respective points on the top of the digital trainer (Figure 4-5, page 36 and Figure7-3 & 7-4, page 48 ). Ask the technician for assistance if needed.

The L.E.D. drivers are now complete. Ask the technician or Professor to check them and show you how they work. Then have your work graded.

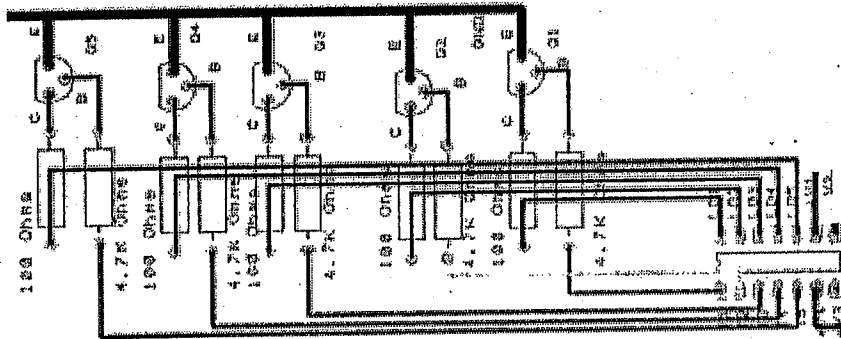


FIGURE 7-5



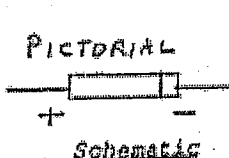


FIGURE 7-1  
THE L.E.D.



OR



Typical Configurations

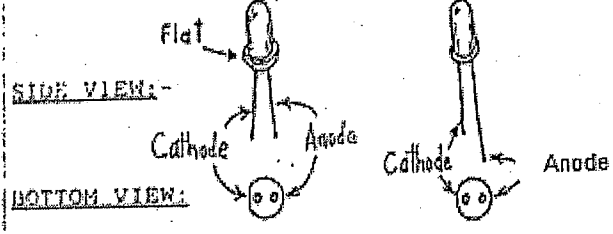
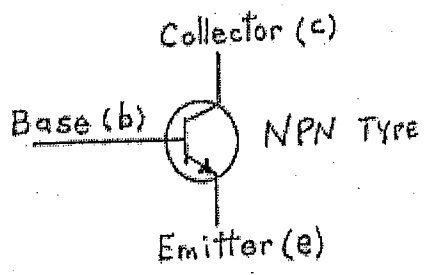
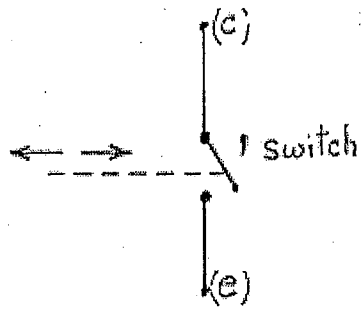


FIGURE 7-2  
The Transistor

Schematic

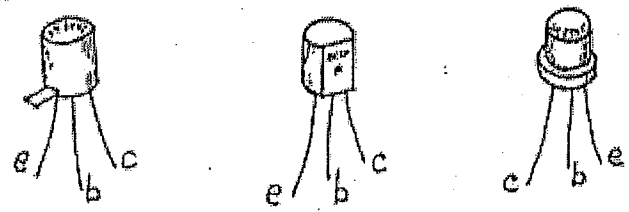


Mechanical Analogy



Typical Transistor Configurations

Side View:



Bottom View:



FIGURE 7-3

Light Emitting Diodes

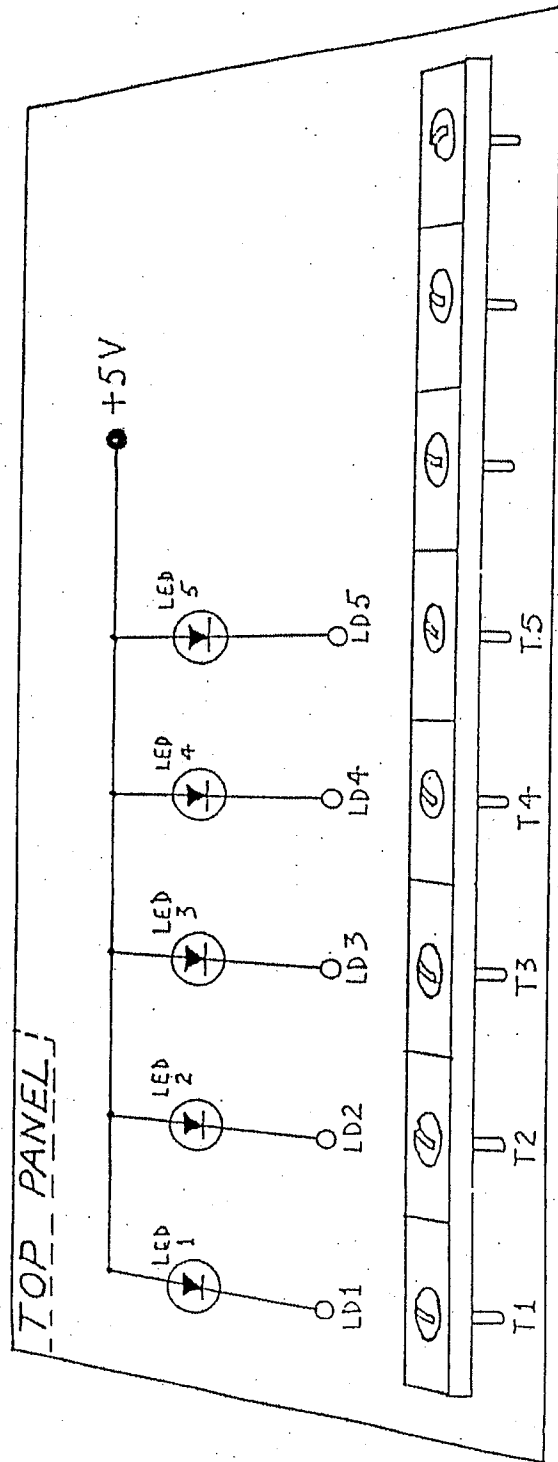
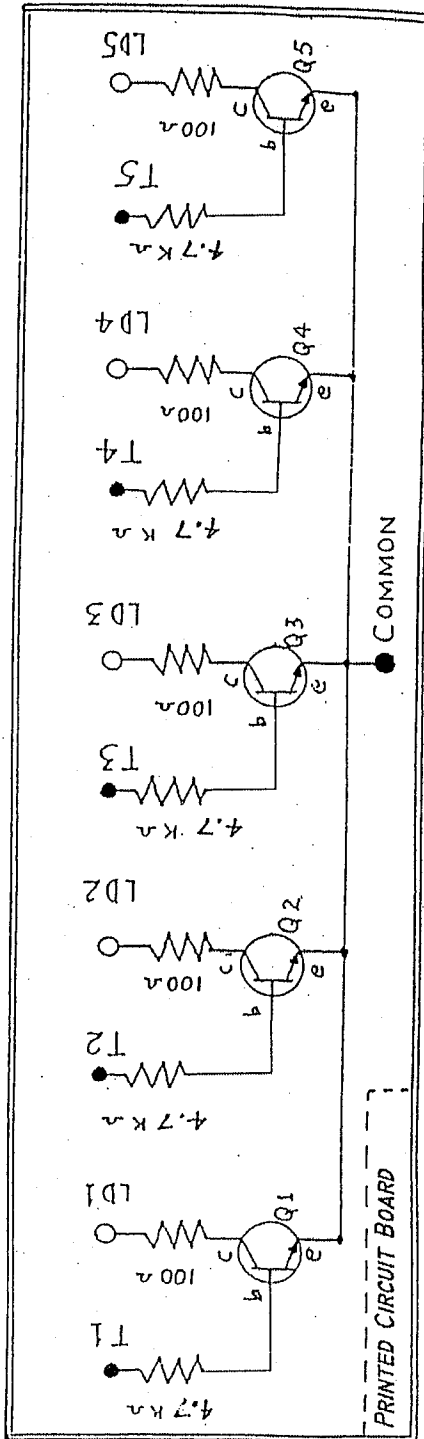


FIGURE 7-4

L.E.D. Drivers



## The DPDT TOGGLE SWITCHES

Performance Span: 1 session (complete at home if necessary)

### Materials Required :

- 4- Double Pole Double Throw Switches
- 4- 1K $\Omega$  resistors (1000)
- 1- 8 pin Terminal Feed-through Strip

### Overview

These switches will provide 2-state input signals - either 0 or 5 Volts - for Digital Circuits. Each switch can provide both inputs simultaneously (eg. A and  $\bar{A}$ ), since you will construct an Inverter circuit for each. The four 1K  $\Omega$  resistors limit the current at the switch terminals avoiding the possibility of a short. Figure 8-1 (page 40) shows some types of switch configurations.

### Wiring

1. Standard DPDT toggle switches work the following way :- toggle UP will close the upper terminals while toggle DOWN will close the lower terminals (see Figure 8-2). Test the continuity of your switches with a meter to ensure they make contact as shown. IF THEY ARE DIFFERENT, SHOW THE TECHNICIAN who will give you a special wiring diagram.
2. The switches and the terminal strip are first mounted on the Top Panel as shown in Figure 4-5.(see page 36)
3. Cross-connect the outer poles of each switch as shown in Fig.8-3 (page 51) using small pieces of insulated wire.
4. Insulate and solder the common (center) poles of the switches in SEQUENCE (see Fig.8-3) to the legs of the respective feed-through terminals - A,  $\bar{A}$ , B,  $\bar{B}$ , C,  $\bar{C}$ , D, and  $\bar{D}$  exactly as shown.
5. Mount the four 1K $\Omega$  resistors to the PC board. The remaining four connections on the dip pin connector in figure 8- 4, are the resistors connections to the toggle switches on the top of the box. Connect the cable as shown in Fig 8-3 (page ).
6. Finally, solder a length of (BLACK) wire from the common (Gnd) terminal on the top section of the box to the first switch as shown in Fig.8-3. Then use three short pieces of BLACK wire to connect the other three switches. (see figure 8-3)

The Toggle Switches are now complete. Ask the Technician to test them, and to show you how they work! Then have your work graded.

FIGURE 8-1

Some Typical Switch Configurations

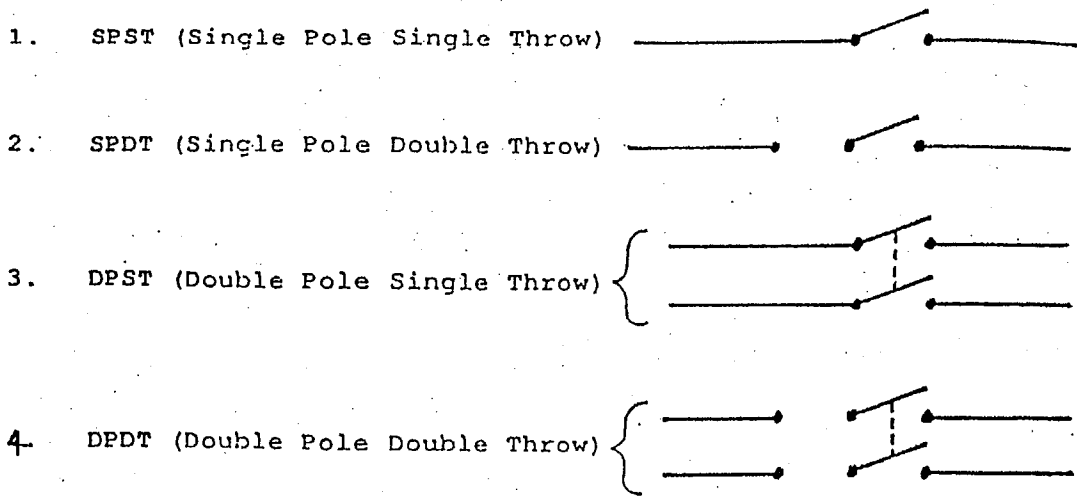


FIGURE 8-2

Standard DPDT Toggle Switch Operation

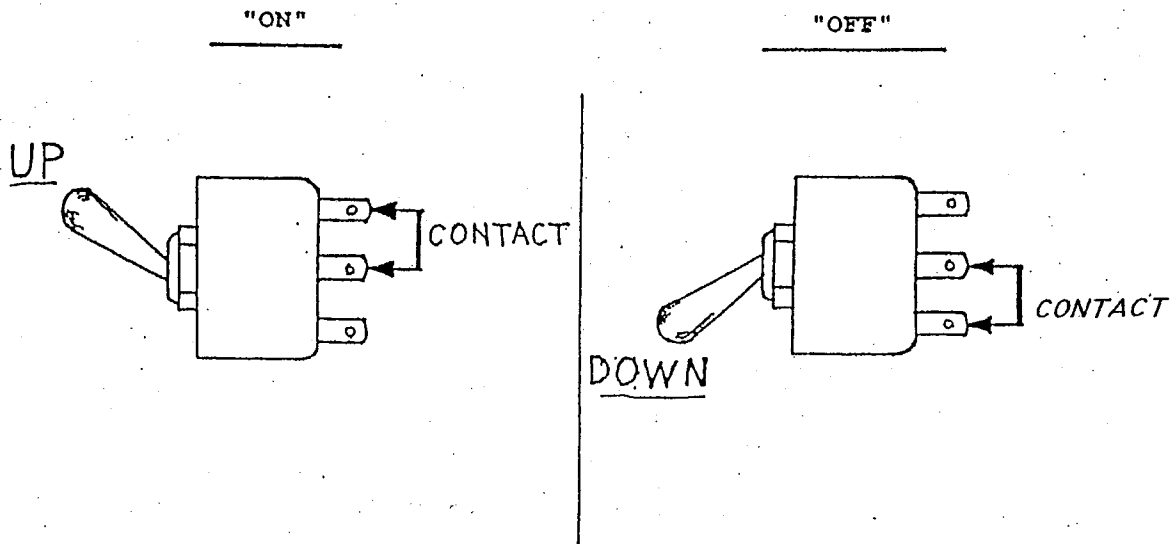


FIGURE 8-3

Wiring the Four Toggle Switches (BOTTOM VIEW)

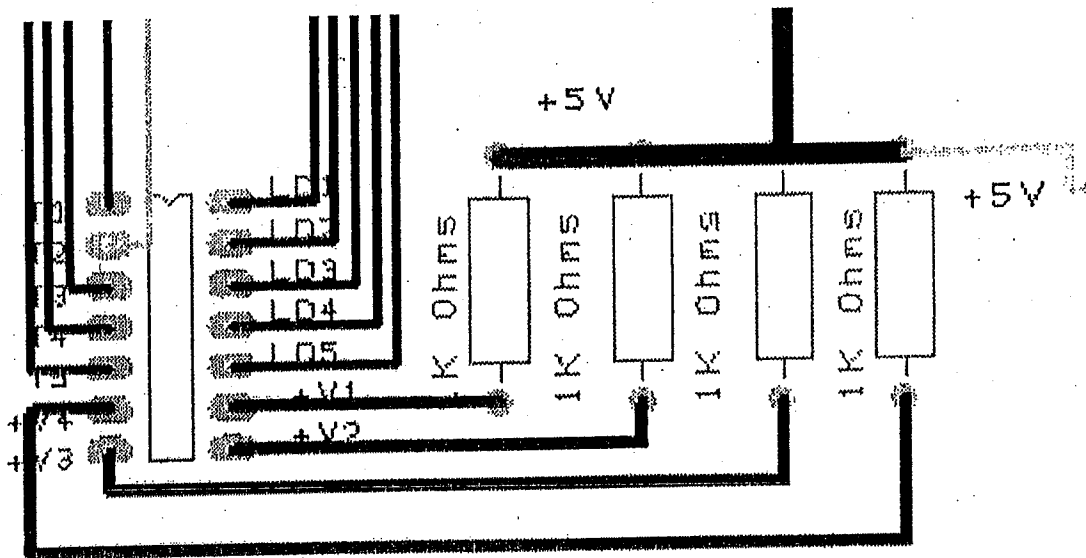
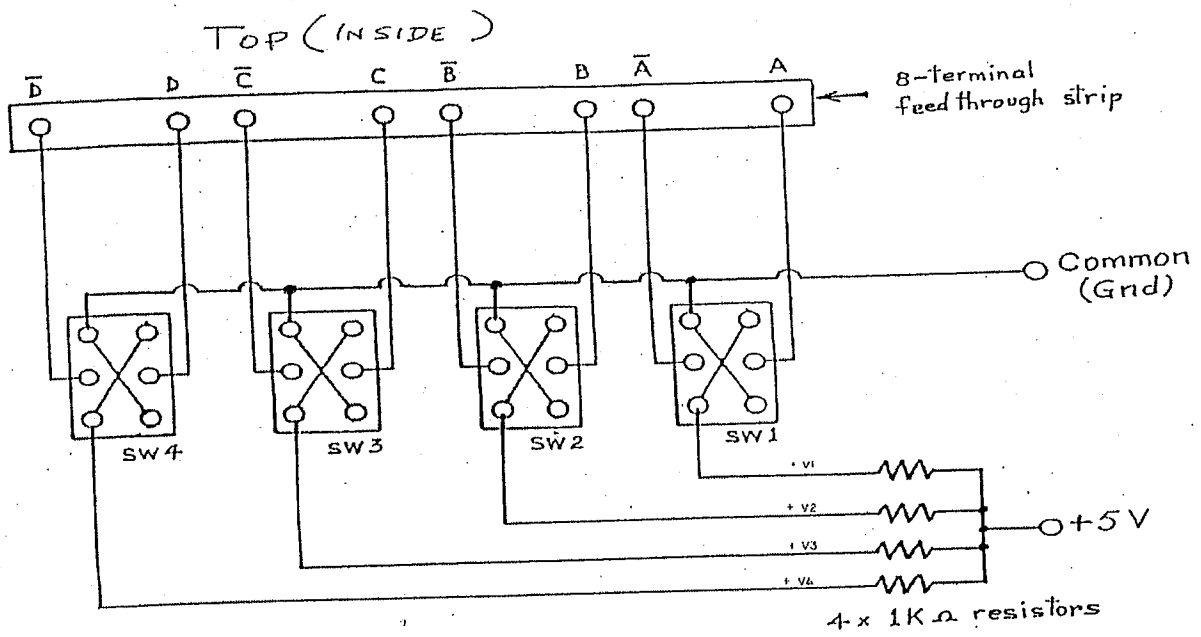


FIGURE 8-4

## WORKING WITH IC CHIPS

For the next three Projects, we will be working with IC Chips.

The abbreviations "IC" are short for "INTEGRATED CIRCUIT". A Chip is a small semiconductor device which can perform the work of numerous Transistors and other components due to its Integrated circuitry. The chip has a number of contact pins (or legs) protruding from the sides so that you can solder it into a circuit board, or plug it into a specially made socket. Chips come in different sizes, and have varying numbers of pins depending on their function. For example, some chips have 8 pins while others have 14 or 16 pins.

The figure below shows two Digital IC chips. Notice the rows of pins on the two sides.



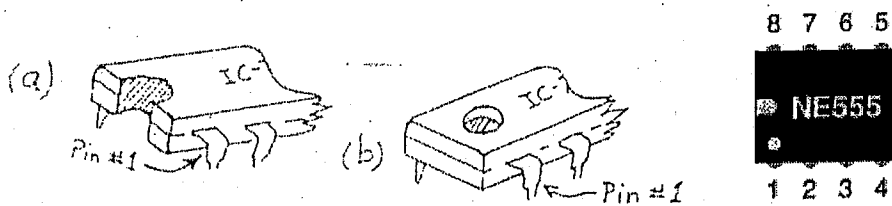
Digital IC

Each pin has a specific function, and most times if you insert a chip the wrong way, permanent damage will result. Therefore, it is important that you know how to identify the correct pin positions.

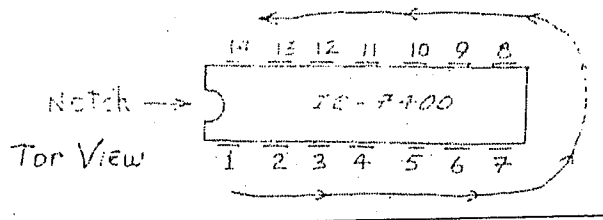
### IDENTIFYING PIN POSITIONS

All chips MUST have an identifying mark

- (a) A SEMI-CIRCULAR cutout at one end of the chip,
- (b) A CIRCULAR counter-sink in the top and to one end or
- (c) Some chips might have BOTH marks



When the chip is positioned with this MARK on the LEFT-HAND side, the pin to the BOTTOM LEFT will be PIN # 1. The other pins are then numbered in a counter-clockwise direction moving from pin #1.



## THE MOMENTARY (Bounceless) SWITCHES

Performance Span: 1 session (complete at home if necessary)

### Materials Required:

- 2 - Momentary (or bounceless) SPDT switches
- 4 - 1K $\Omega$  resistors (1000 ohms)
- 1 - IC 7400 NAND Gate
- 1 - 14 pin Socket
- 1 - 16 pin Socket
- 1 - 16 pin Dip Connector

### Overview:

The Momentary or Bounceless Switches will be used as clock inputs for various Digital Circuits since they produce one perfect clock pulse each time we depress and release the switches. By using these instead of a real pulse-generator, we can carefully analyze what happens each time a clock pulse is sent.

### Wiring:

\* Figure 9-1 (page 55) shows the schematic Logic diagram for the two Momentary (Bounceless) Switches.

\* Figure 9-2 shows the physical layout and actual pin connection for the chip, as viewed from the **BOTTOM** of the vector board.

Note: Pin # 1 now appears at the **TOP-LEFT** of the chip.

1. Insert the 14-pin socket in the PC board as shown in figure 9-3, (page 54) and solder all pins to the board. **DO NOT INSERT THE CHIP AT THIS POINT.**
2. Now place the four 1 K $\Omega$  resistors in the area indicated on the PC board in Figure 9-3. Solder and trim any protruding wires.
3. Insert the 16-pin socket in the PC board and solder all pins.
4. Place the 16 pin dip connector in the 16 pin socket, and connect the cables that indicate Q1,  $\overline{Q1}$ , Q2,  $\overline{Q2}$ , NO1, NC1, NO2 and NC2 to the top section of the Box. (see pg 36) Insulate and solder all connections to the terminal feed trough strips.
5. Connect **GND** from a toggle switch to the legs of the momentary switches label C.

6. Now insert the 7400 IC into the socket. BE SURE YOU INSERT THE CHIP THE CORRECT WAY or damage may result.

The Momentary Switches are now complete. Ask the technician to test them and to show you how they work. Then have your work graded.

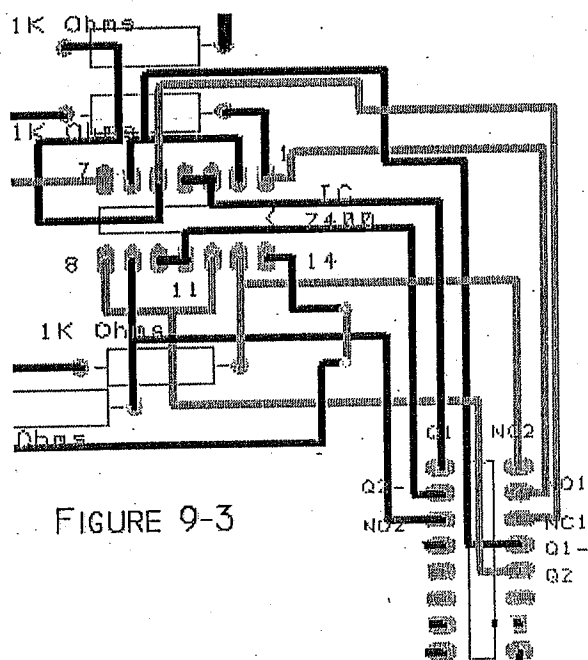




FIGURE 9-1

Logic Diagram

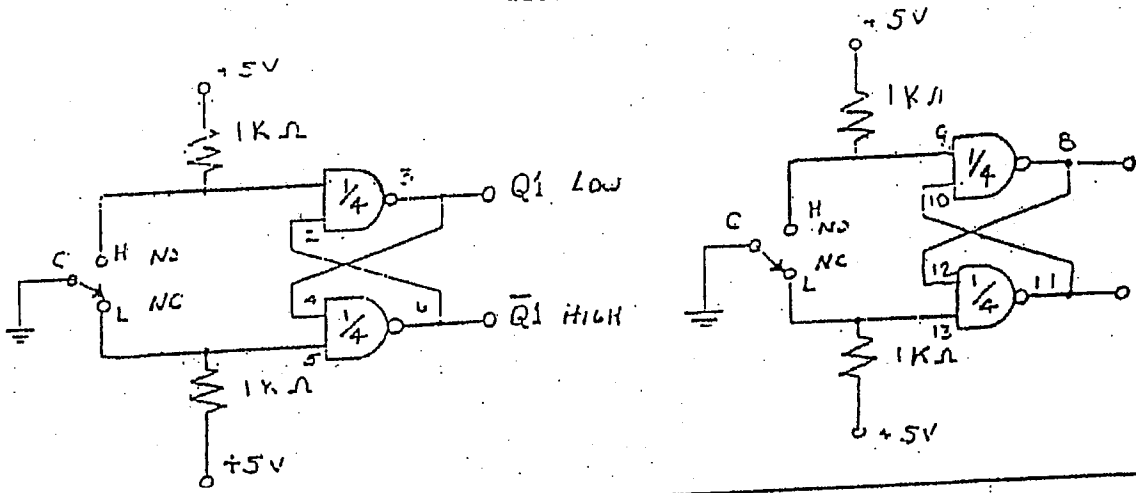
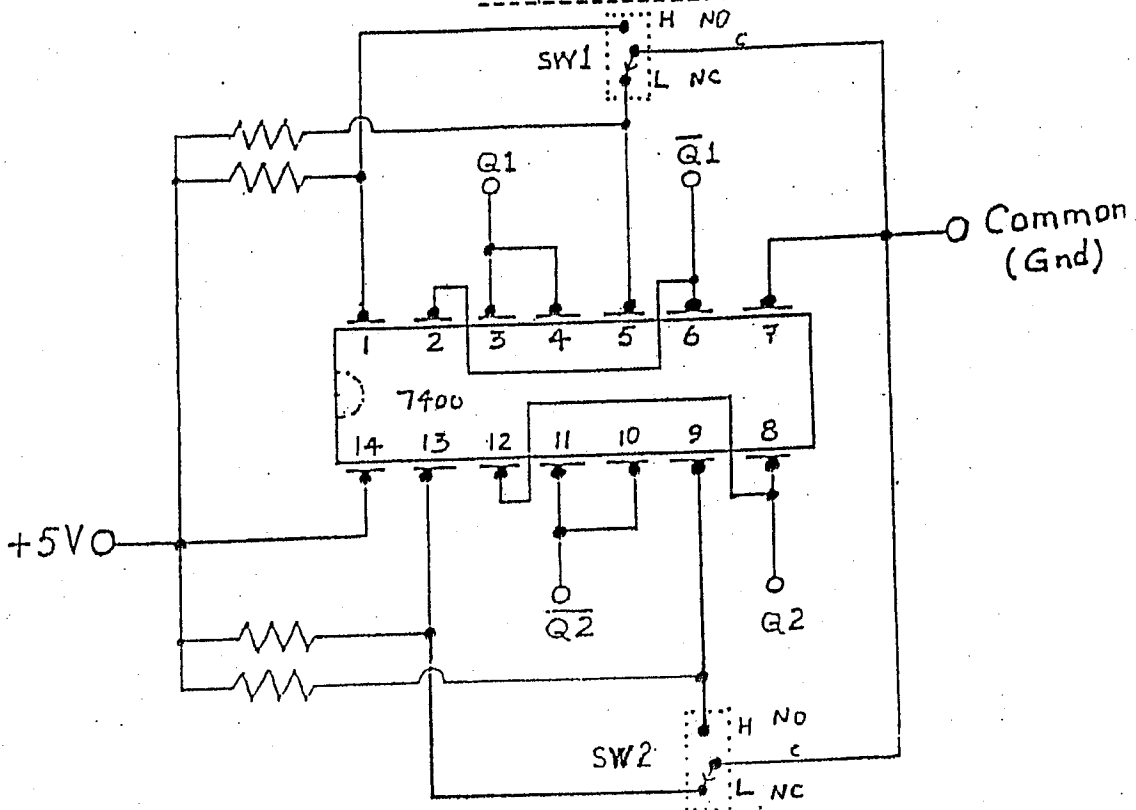


FIGURE 9-2

Physical Layout

(BOTTOM VIEW)



## The DIGITAL LOGIC PROBE

Performance Span: 1 session (complete at home if necessary)

### Materials Required

2— L.E.D's (one RED, one Green)	1 — 14 pin Wire Wrap Socket
2 — L.E.D Holders	1 — 470 ohm resistor
1 — IC 7404 Hex Inverter chip	1 — diode (general purpose)

### Overview

The Digital Logic Probe is an instrument used for testing and trouble-shooting Digital circuits. The two L.E.D's indicate to us whether the point being tested is HIGH (red) or LOW (green).

### Wiring

\* Figure 10 - 1 (Page 58) shows the schematic Logic diagram for the Logic Probe.

\* Figure 10 - 2 (Page 58) shows the physical layout and actual pin connections for the IC-7404 H4ex Inverter chip, as viewed from the BOTTOM of the vector board.

\*Figure 10-3 (Page 57) shows the PC board layout for this circuit.

1. Insert the 14- pin socket in the PC board and solder all pins to the board on the other side. **DO NOT INSERT THE CHIP AT THIS POINT.**
2. Place diode so that the cathode end is connected to pin # 5 as shown in Fig: 10 - 2. Have the position of the diode checked by the technician before soldering
3. Place the 470 ohm resistor in the position indicated. Solder the diode and resistor to the board. Trim any protruding wires.
4. Fig. 5 - 4 (Page 36) shows the position of the two L.E.D's. Insert the L.E.D holders first, then the L.E.D's as before.
5. Locate the five wire connections for this circuit from the 16 pin dip connector: (Red) R- LED- A (Anode), R- LED-C (Cathode), G(Green) - LED- A, G- LED- C and T- 8. (Anode is the longer leg and Cathode is the shorter leg)

6. Insulate and solder all connections to the LEDs and the feed through terminal strip.
7. Finally insert the 7404 IC chip into the socket. **BE SURE YOU INSERT THE CHIP THE CORRECT WAY** or damage may result

The Logic Probe is now complete. Ask the Technician to test it, and show you how it should work! Then have it graded.

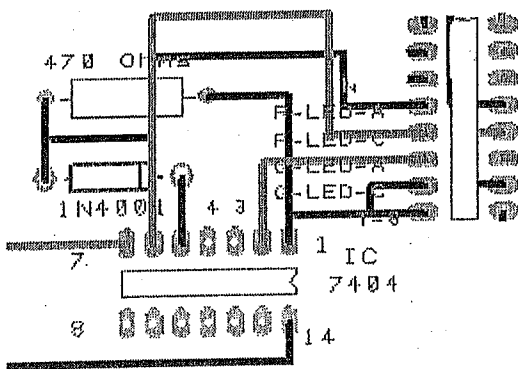


FIGURE 10-3

FIGURE 10-1

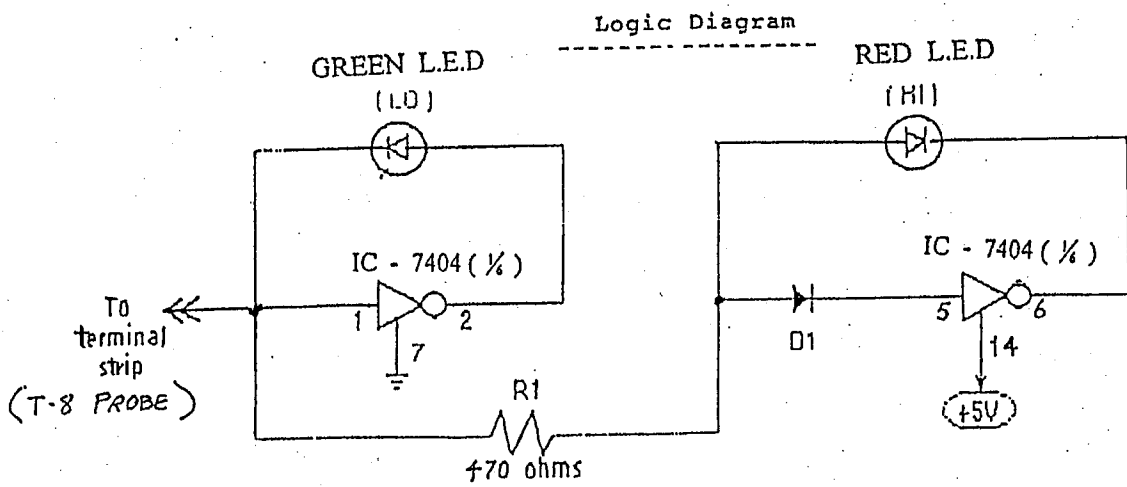
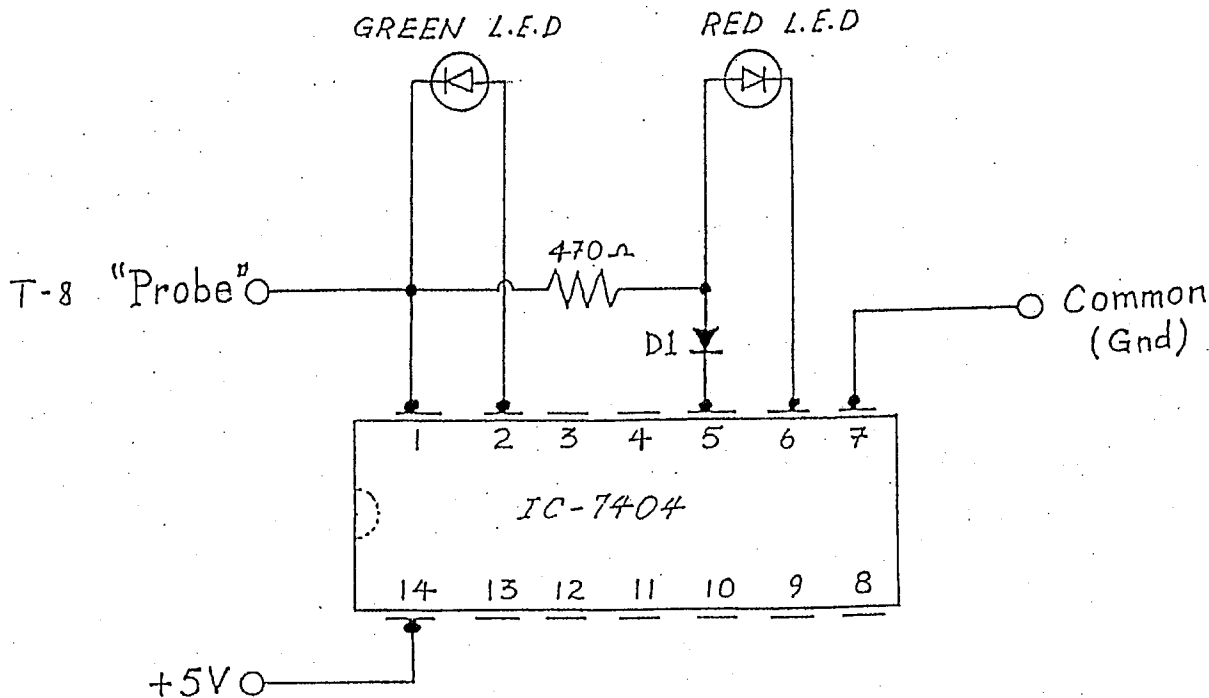


FIGURE 10-2

Physical Layout (BOTTOM VIEW)



## The 555 - TIMER (Clock) CIRCUIT

Performance Span: 1 session (complete at home if necessary)

### Materials Required:

- 1—IC 555 Timer
- 1 — 8 pin socket
- 1 — Potentiometer (1 Meg. Ohms)
- 1 —510 ohm resistor
- 1 — Capacitor (1uf)

### Overview

The Timer (or Clock) is a device which produces equally spaced pulses (or square waves) used in Digital circuits. The frequency or rate can be varied by adjusting the potentiometer. When the OUTPUT (Timer) is connected to an L.E.D terminal, (eg: T1) the L.E.D flashes continuously at a certain rate.

### Wiring

- \* Figure 11- 1 (Page 61) shows the schematic for the Timer.
  - \* Figure 11- 2 (Page 61) shows the physical layout and actual pin connections for the IC — 555 Timer, as viewed from the BOTTOM of the vector board.
  - \* Figure 11-3 (Page 60) shows the PC board layout of this circuit.
1. Insert the 8 pin Socket in the PC board and solder all pins to the board. DO NOT INSERT THE CHIP AT THIS TIME.
  2. Place the 510 $\Omega$  resistor and the 1 uf capacitor in the area indicated and solder them to the board. The shorter leg of the capacitor is connected to pin #1 and the longer leg is connected to pin # 2.
  3. Locate the cables for this circuit from the 16 pin dip connector: Pot 1, Pot 2 and T-7.
  4. Solder these cable connections to the top section of the box. (Figure 4-5, page 36 & figure 11-2, page 61)

5. Now insert the 555 timer IC chip into the socket. BE SURE YOU INSERT THE CHIP THE CORRECT WAY or damage may result.

The Timer is now complete. Ask the Technician to test it, and show you how it works! Then have your work graded.

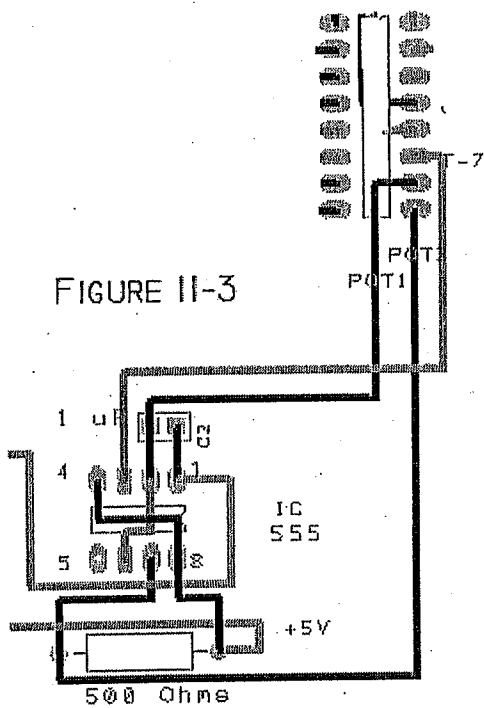


FIGURE 11-1

Schematic Diagram

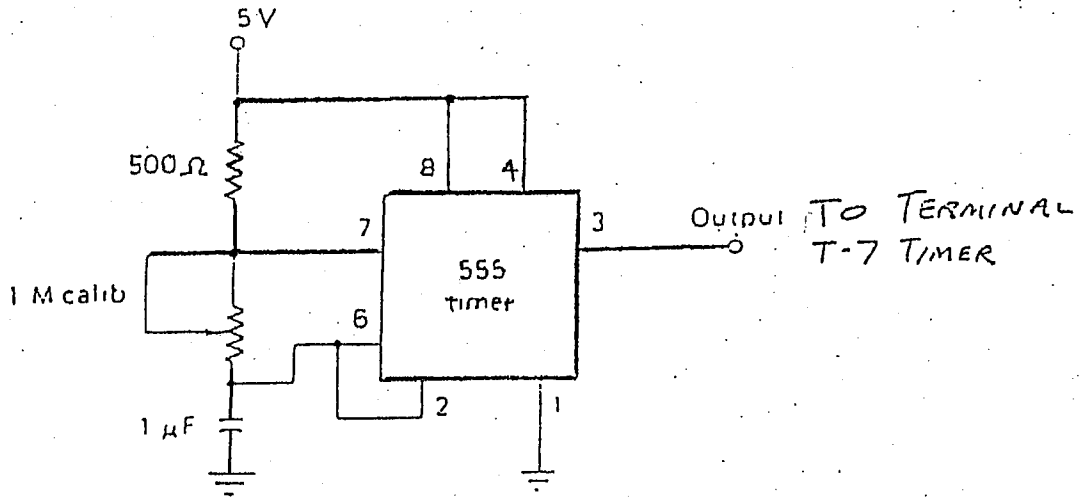
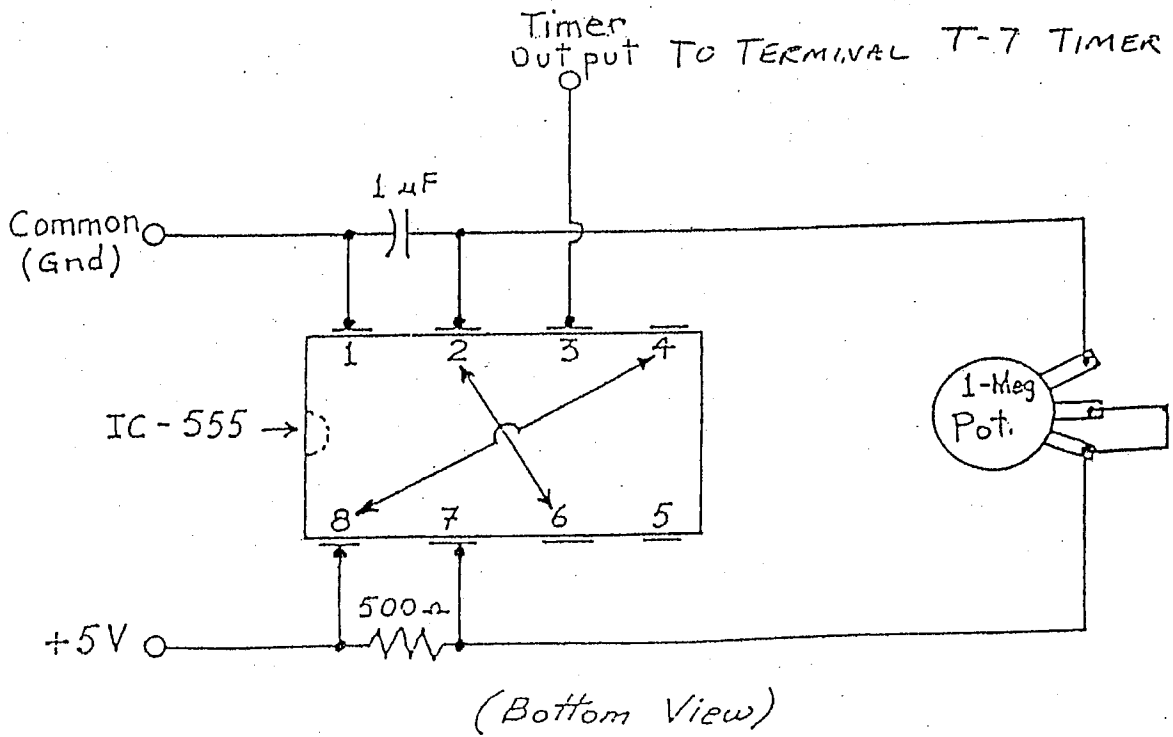


FIGURE 11-2

Physical Layout



Resistor Color-Code. Each resistor has color bands that identify a resistors resistance value and tolerance as shown (start from the end opposite the Tolerance Band):



digit\_ // // \\_ Tolerance Band  
 2~ digit \_// Gold 5%  
 Multiplier! Silver 10%  
 Brown 1%

Digit Color Multiplier

0	Black	(none)
1	Brown	0
2	Red	00
3	Orange	000
4	Yellow	0000
5	Green	00000
6	Blue	000000
7	Violet	0000000
8	Gray	00000000
9	White	000000000

Example:

Brown Black Red Silver - 1000 @ 10%

Or

Gold Red Black Brown - 1000 ~ 5%