

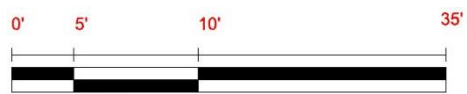

*ARCH 3610*  
*MIDREM SUBMISSION*  
*PROFESSOR APTEKAR*  
*BY: ANZHELLA MESSIAN*

• FLOOR PLAN

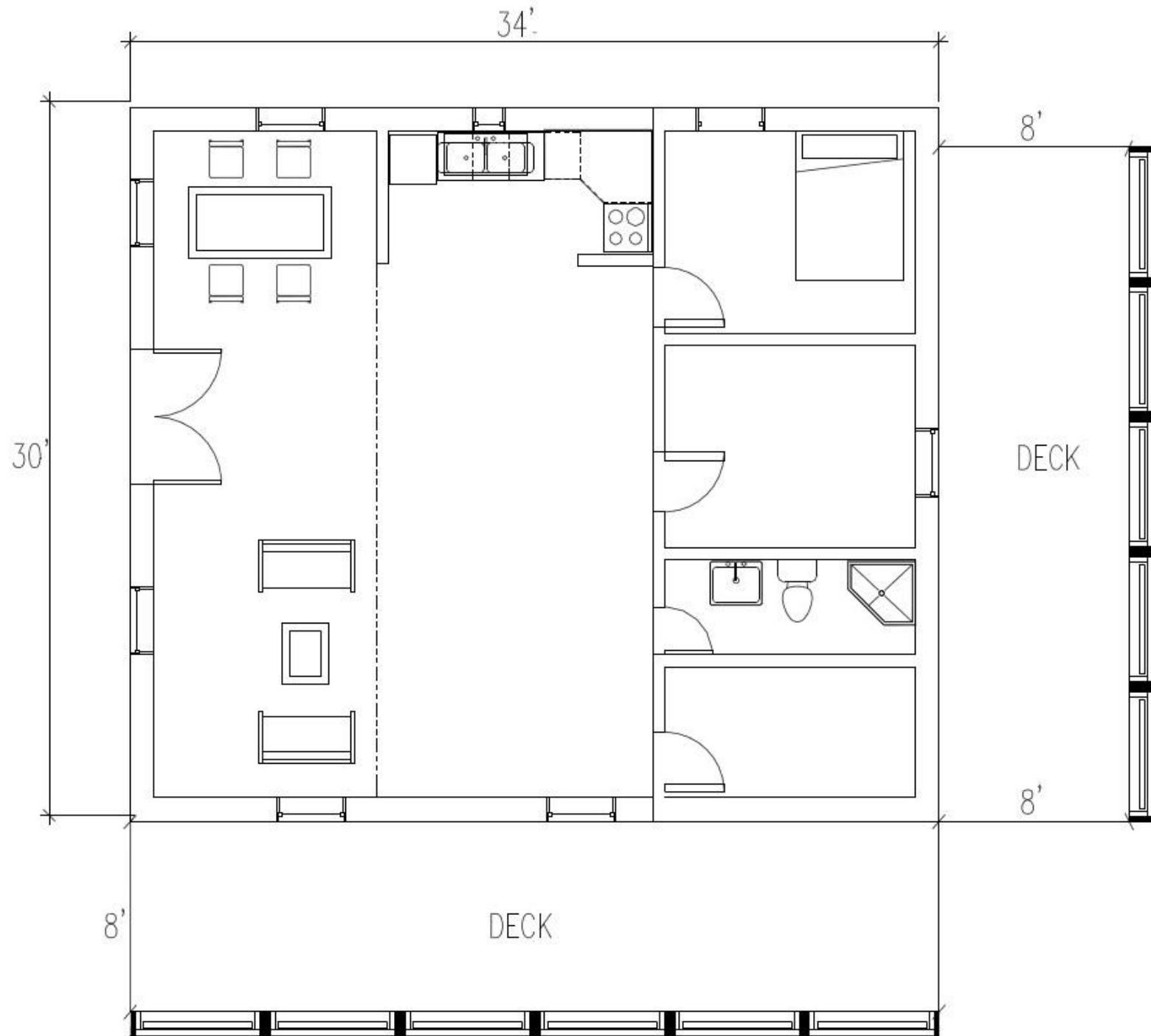

# Solar Panel

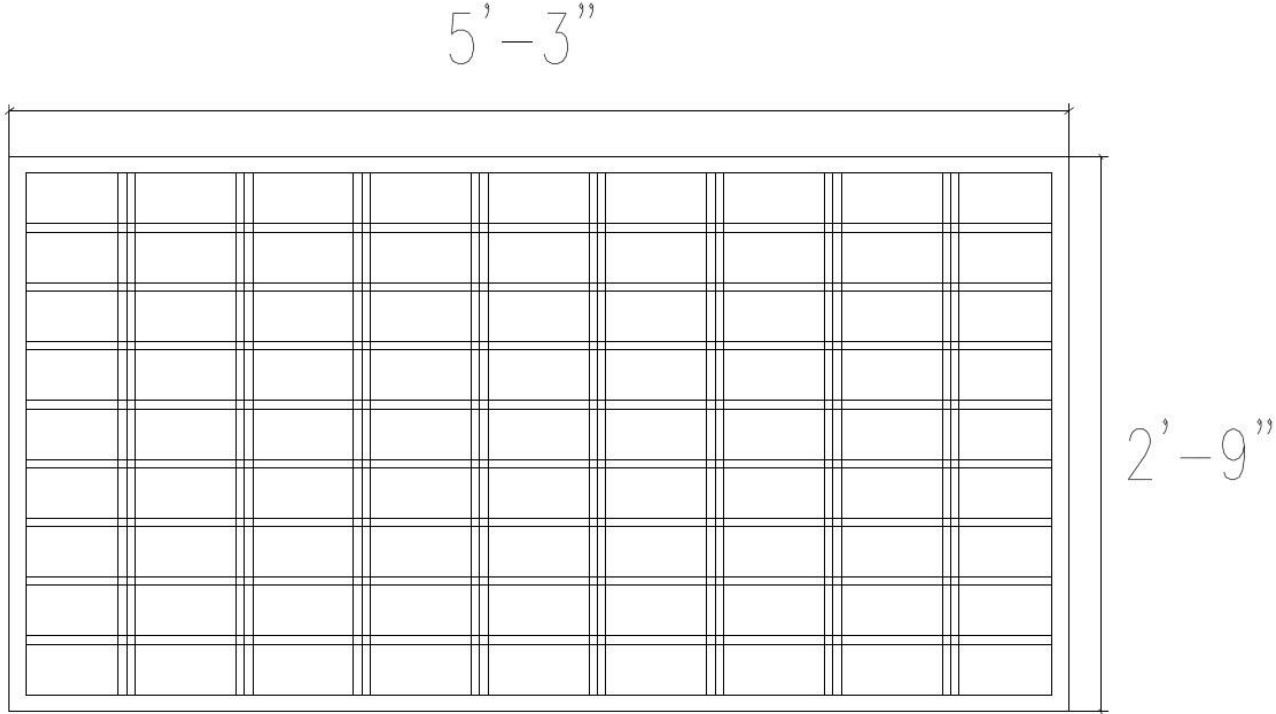

○ SOLAR PANEL

# *Elevation*

- UNIT A

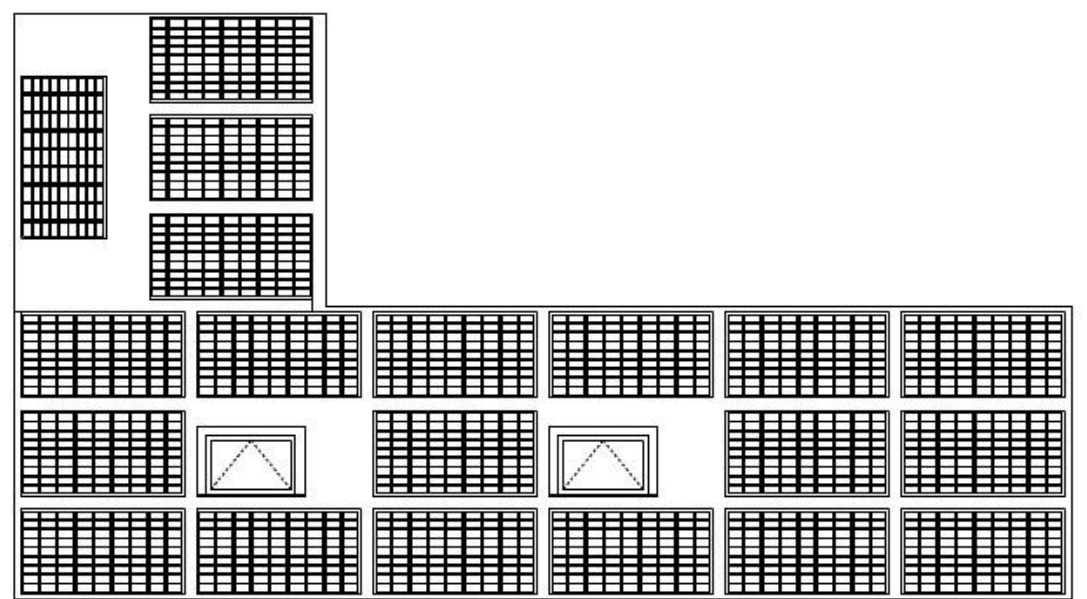
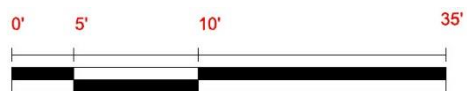

ELEVATION OF UNIT A

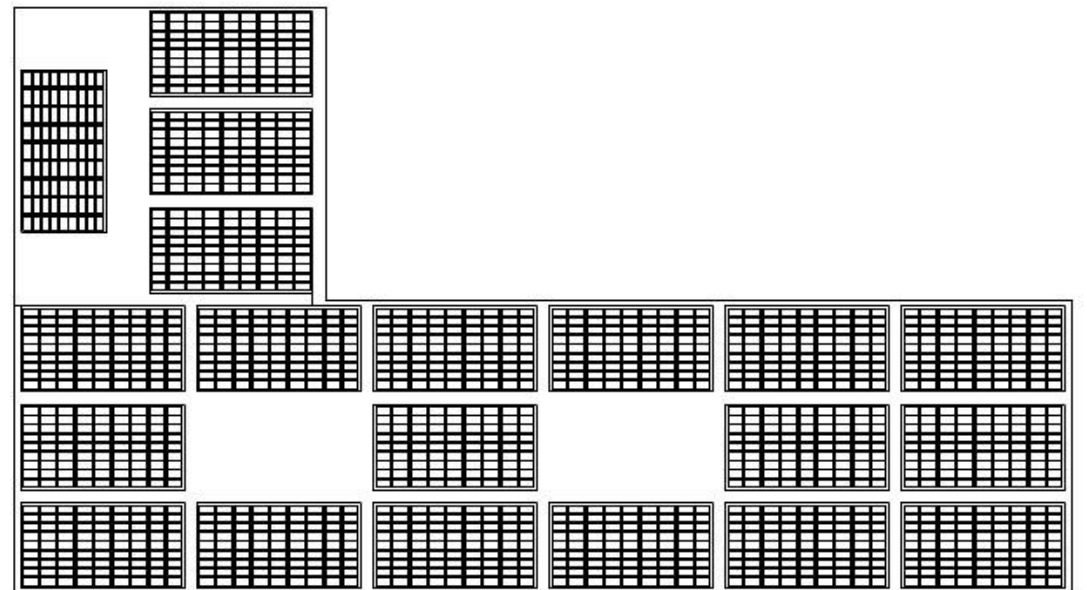

ELEVATION OF UNIT A

# *Elevation*

- UNIT B

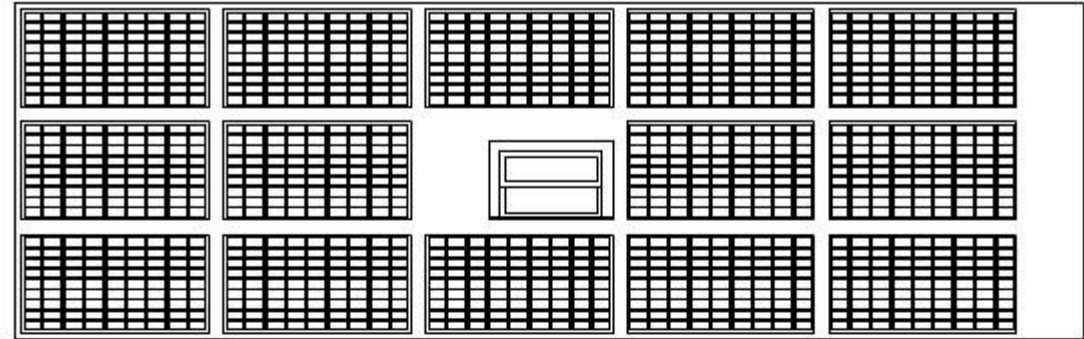

ELEVATION OF UNIT B

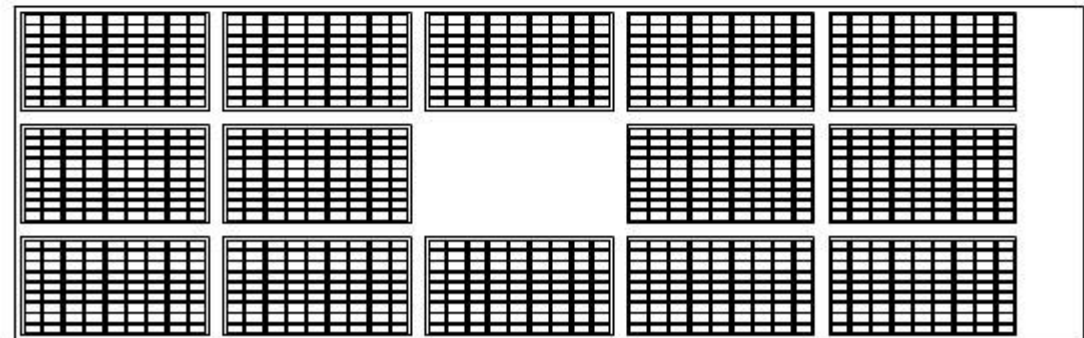

ELEVATION OF UNIT B

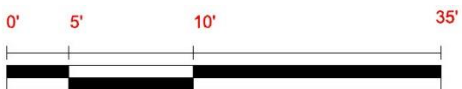

# *Elevation*

- SOUTH ELEVATION

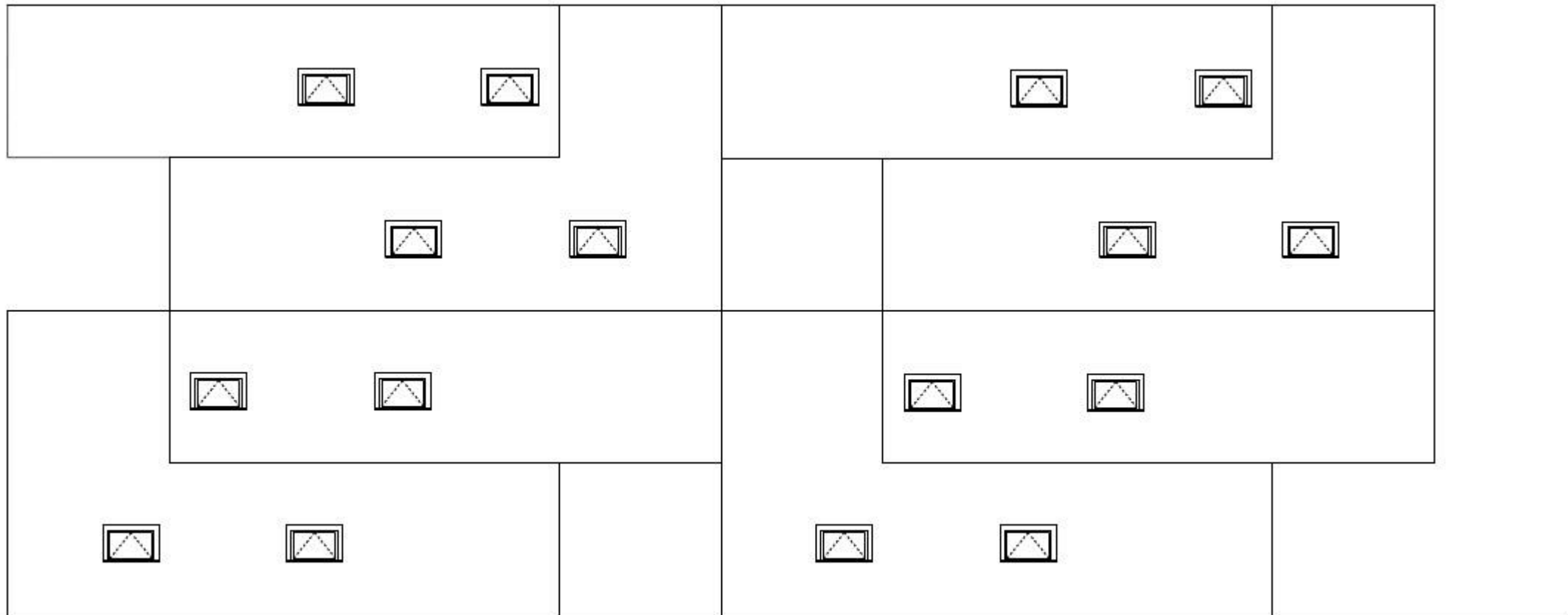

# *Elevation*

- EAST ELEVATION

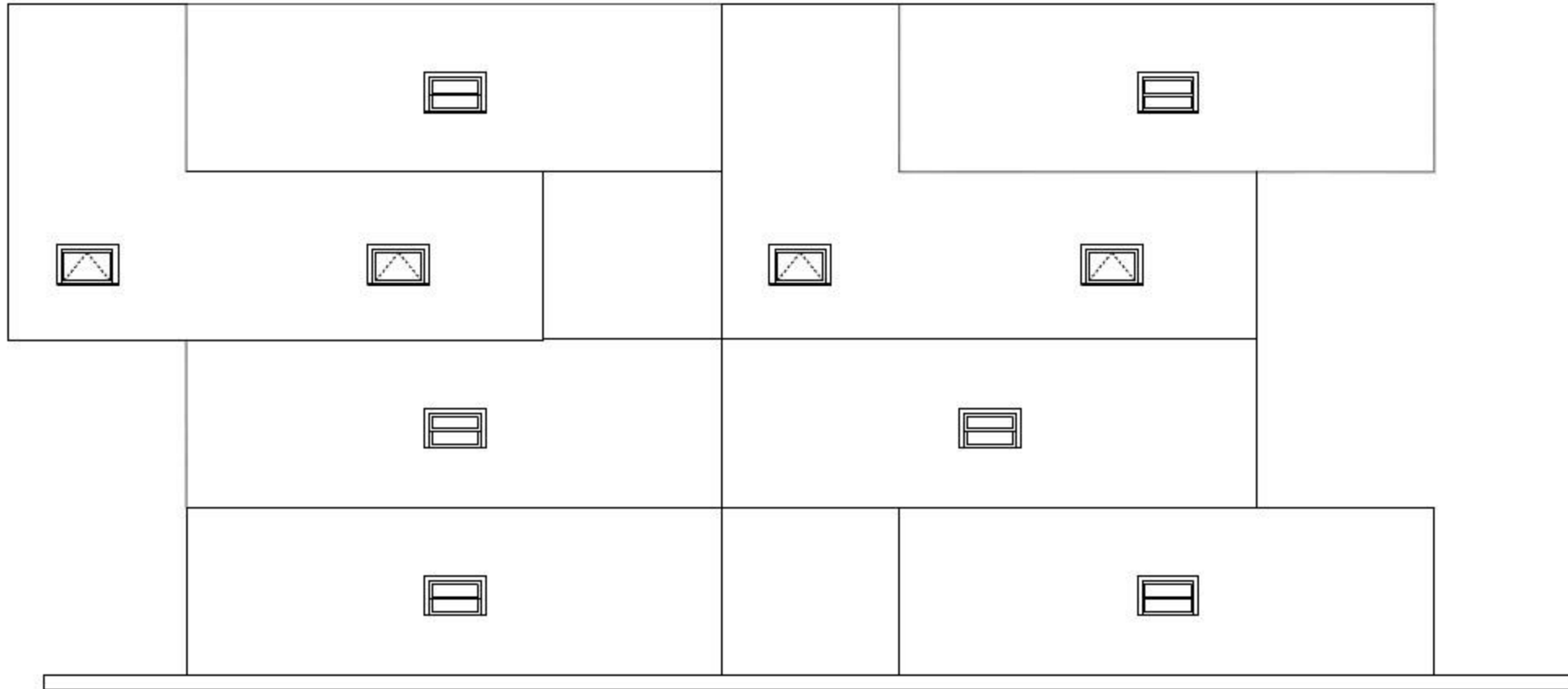

*Diagram*

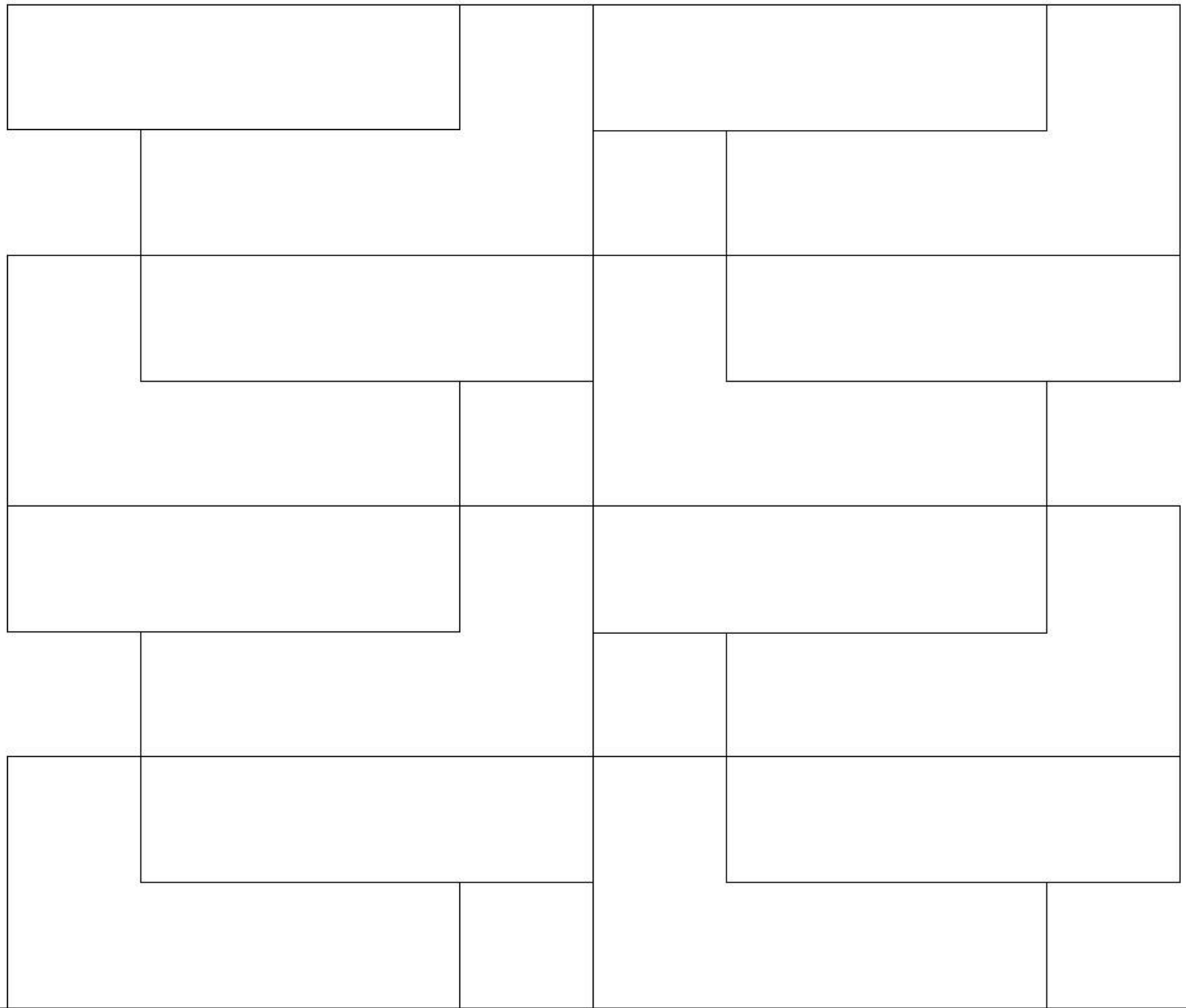

• UNITE STACKING



# Wall Section

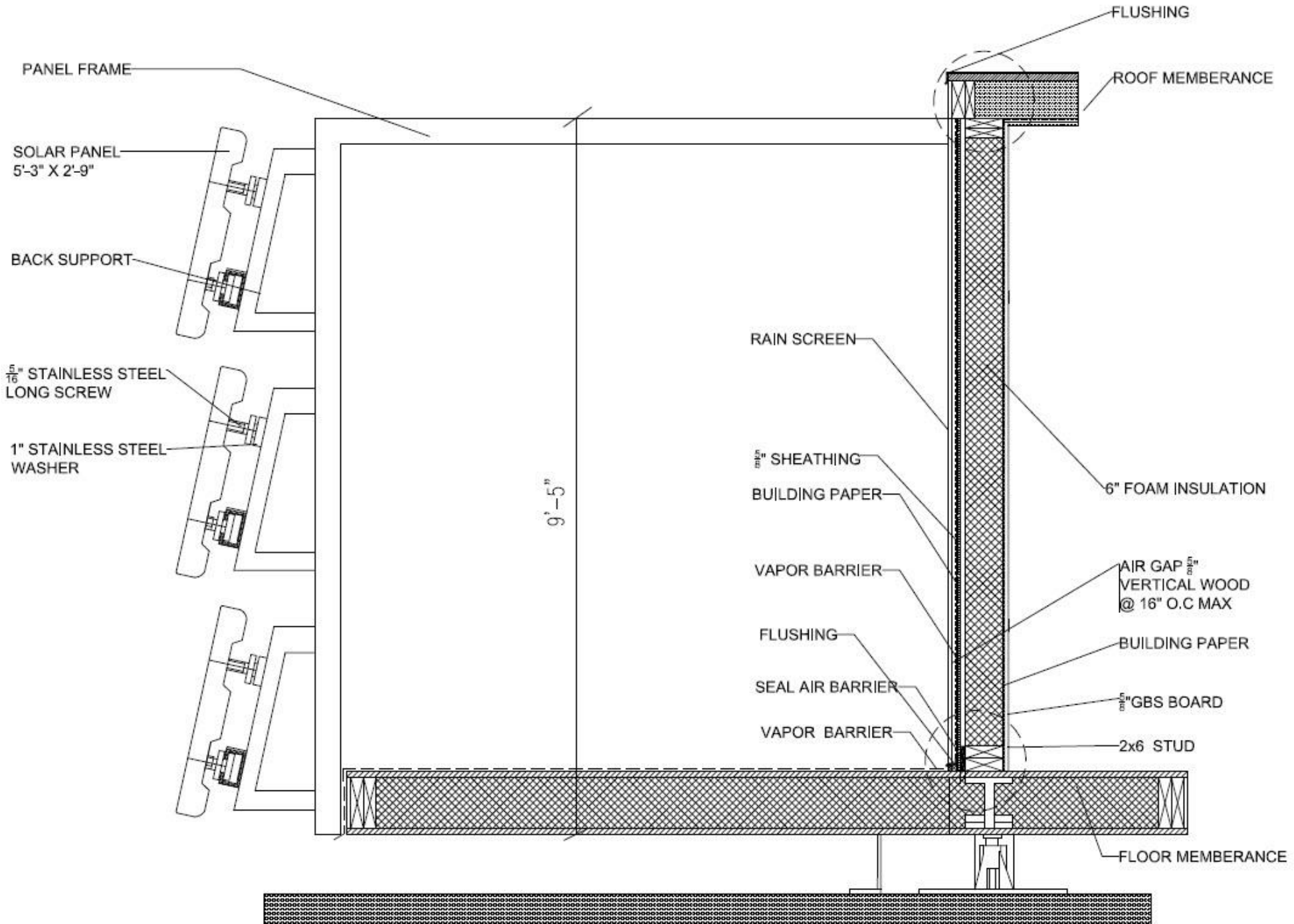

# Details

- *MODULE CONNECTION*

STRUCTURAL STEEL FRAMING

WOOD, PLASTIC, AND  
COMPOSITE FASTENING  
@  $\frac{3}{4}$ " O.C

1-1/8" T&G O.S.B FASTENED  
WITH PPSD SCREW O.C AT  
ALL SUPPORTED EDGES

$\frac{3}{4}$ " PLY WOOD SHIM

COLD FORMED METAL FRAMING

STEEL FRAMING

$\frac{3}{4}$ " WOOD AND  
COMPOSITE FASTENING "

7" SEISMIC  
PERIMETER PIER

$\frac{1}{2}$ " PLYWOOD PAD

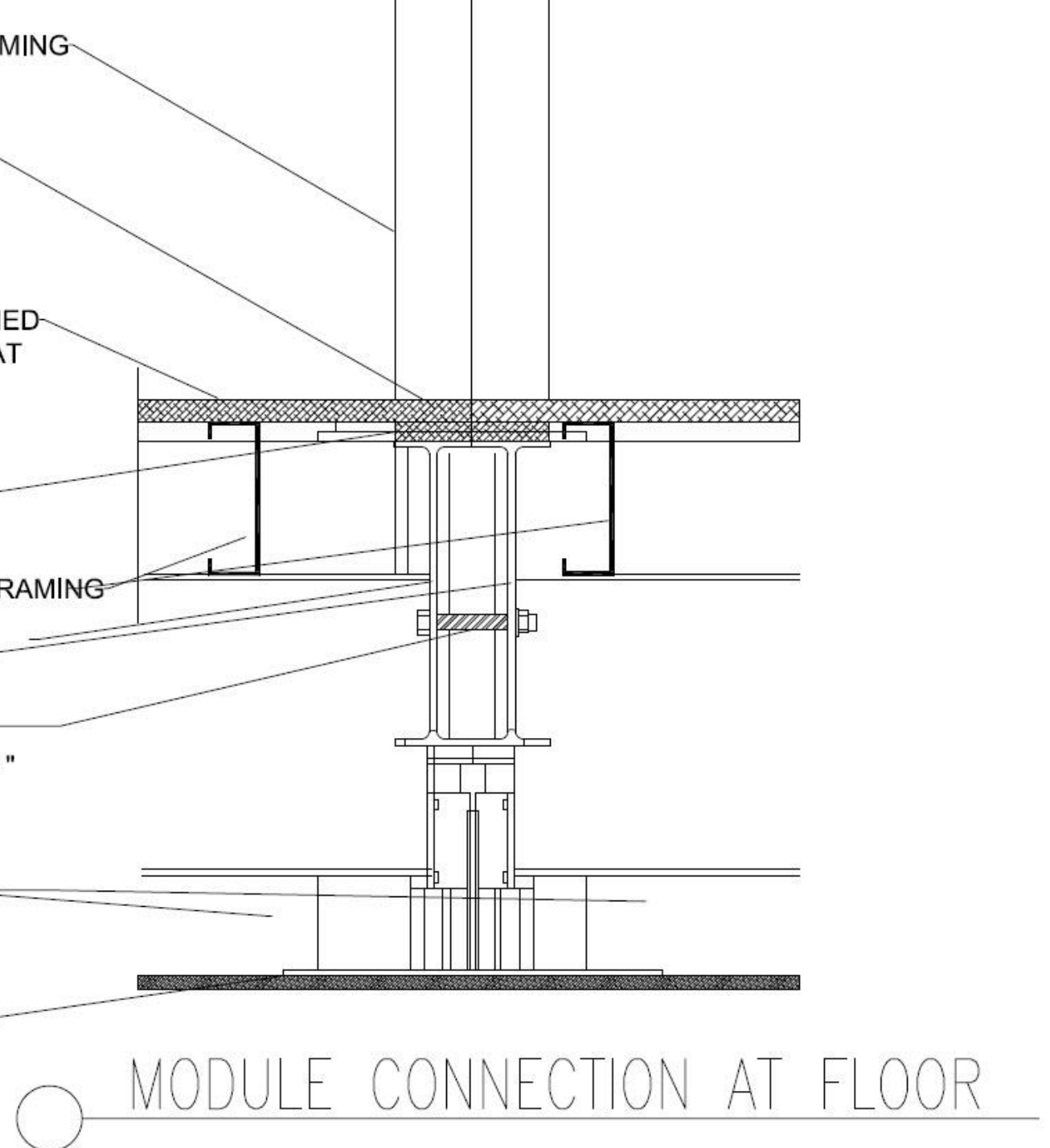

○ MODULE CONNECTION AT FLOOR

# Details

- FLOOR CONNECTION

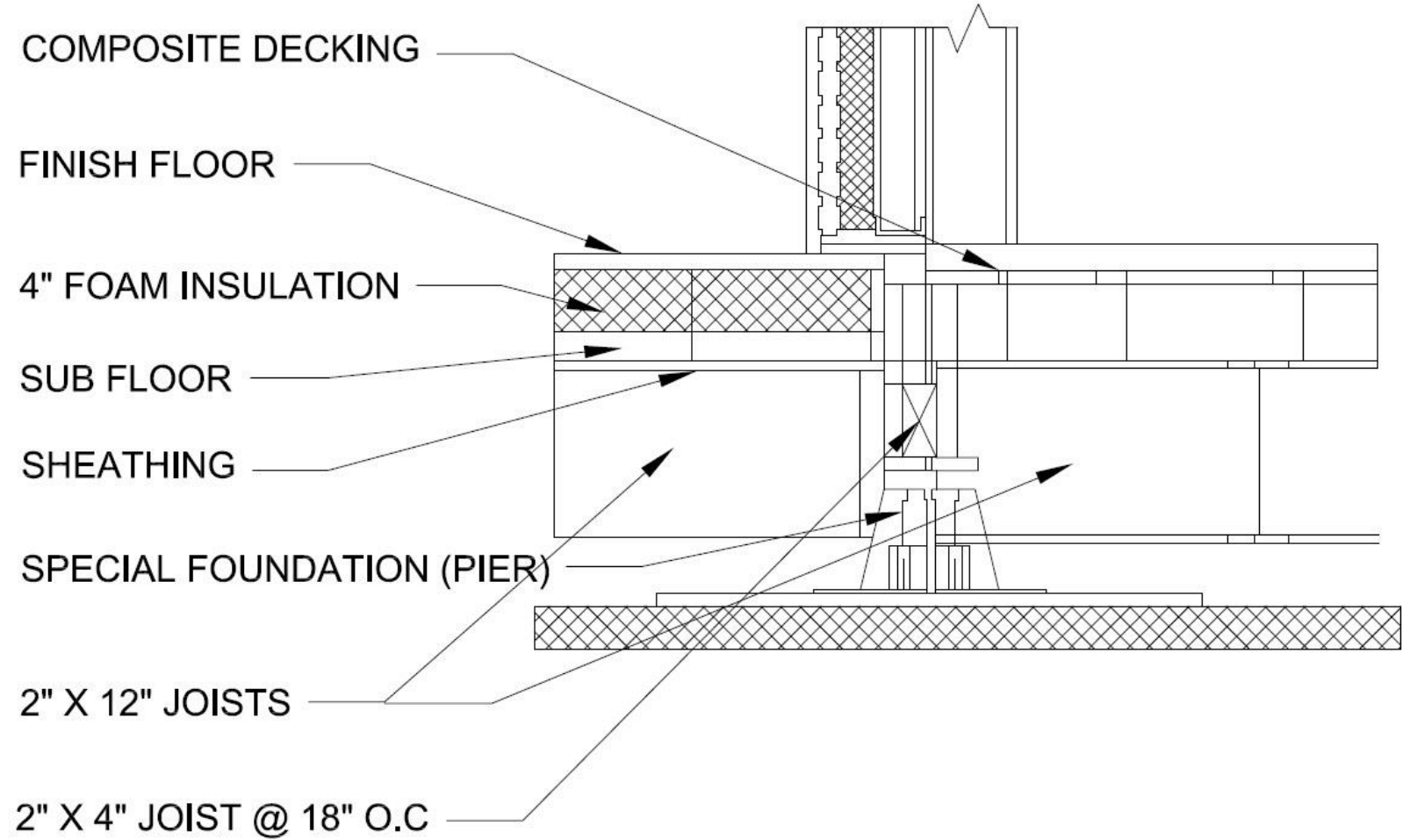

FLOOR CONNECTION DETAILS

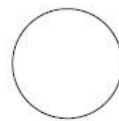

# Details

- WINDOW CONNECTION

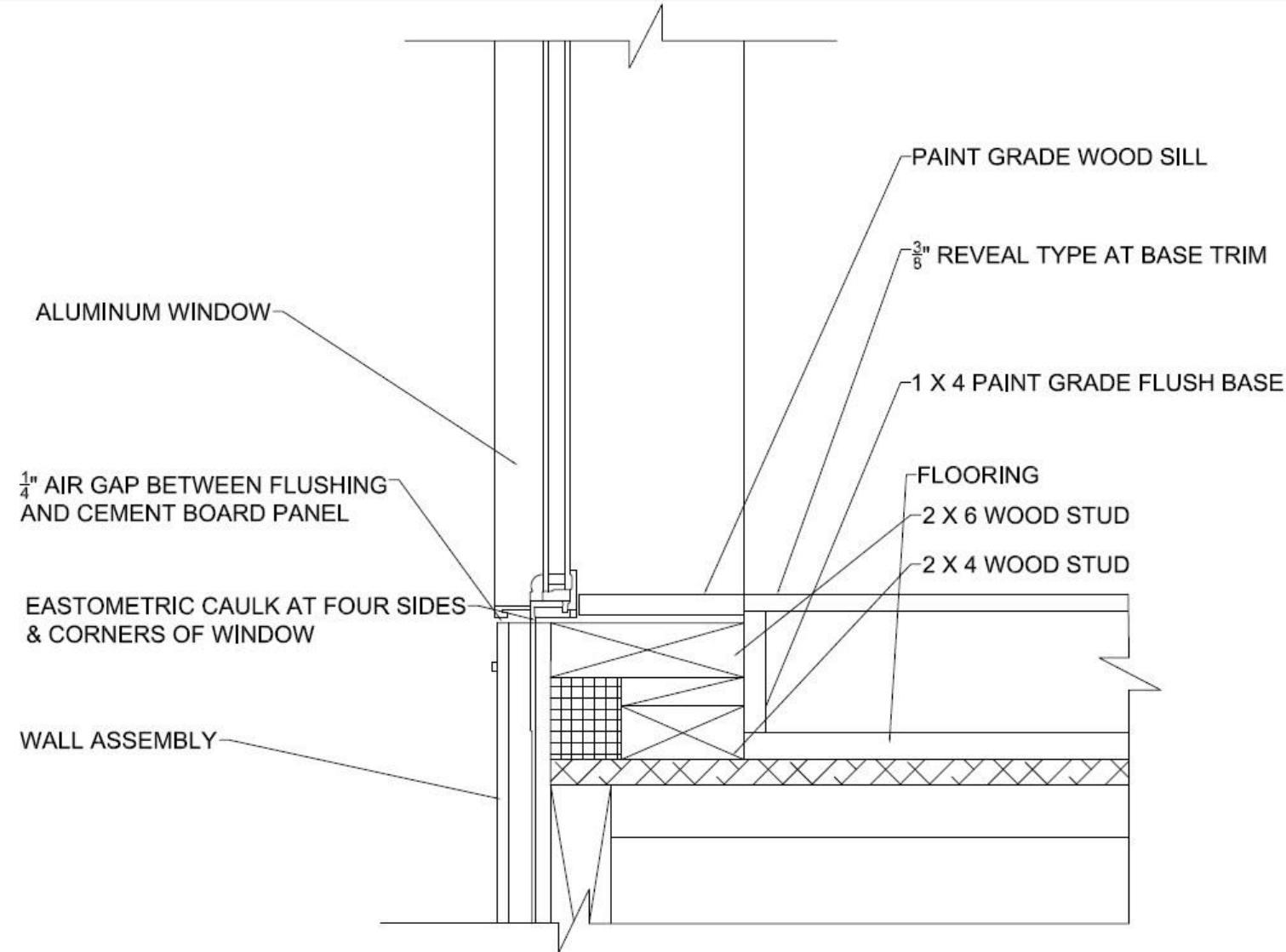

○ WINDOW CONNECTION DETAIL

# Details

- WINDOW OPENING

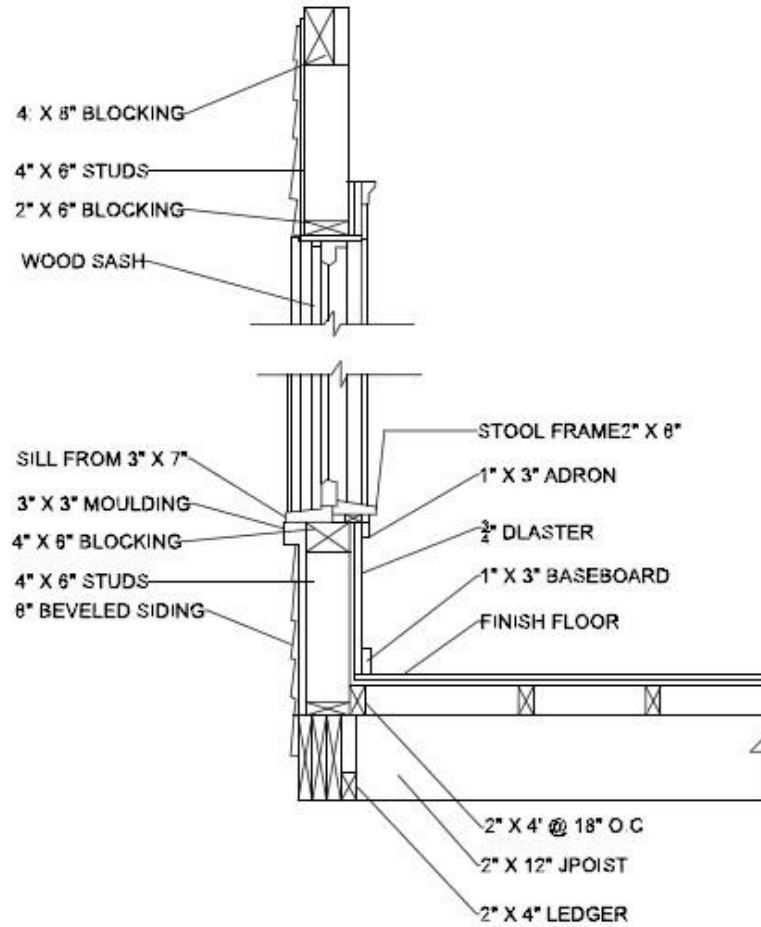

HEAD

JAMB

SILL

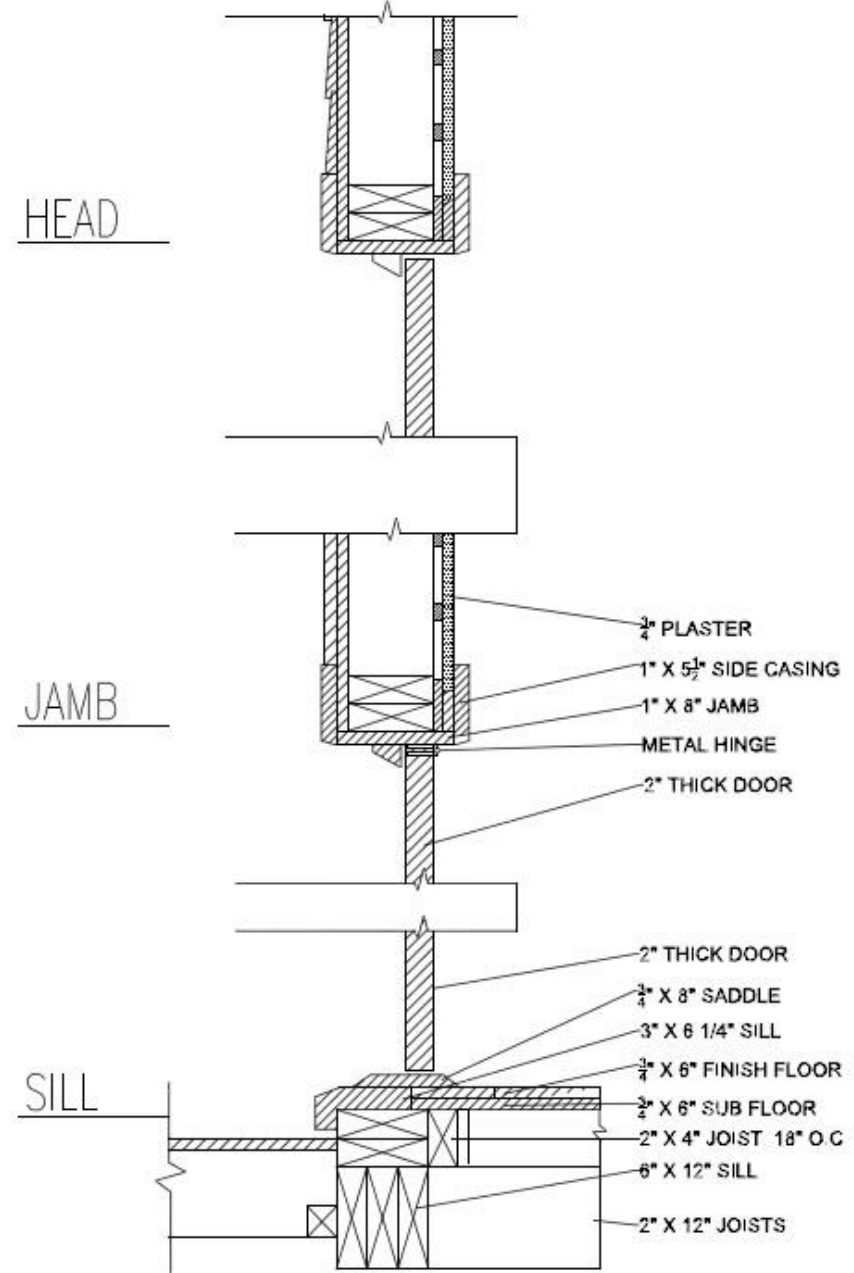

SECTION THRU DOOR

# Sun Study

## Camper Solar Panels With Different Angles

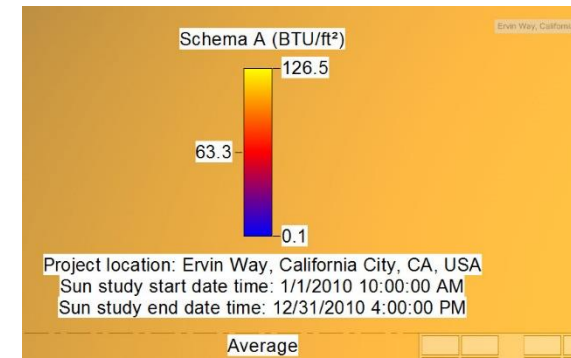



# Solar study – Summer Solstice

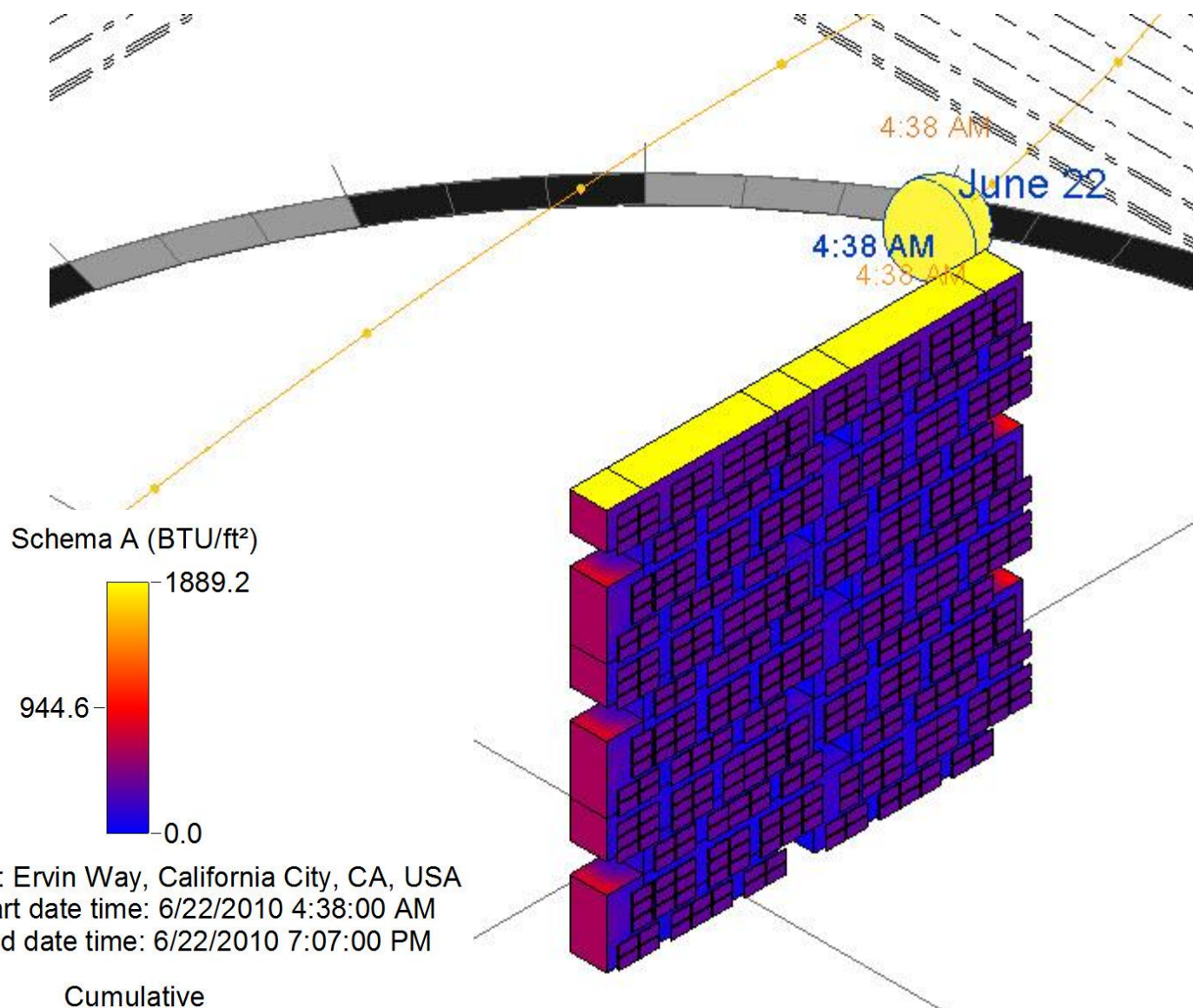
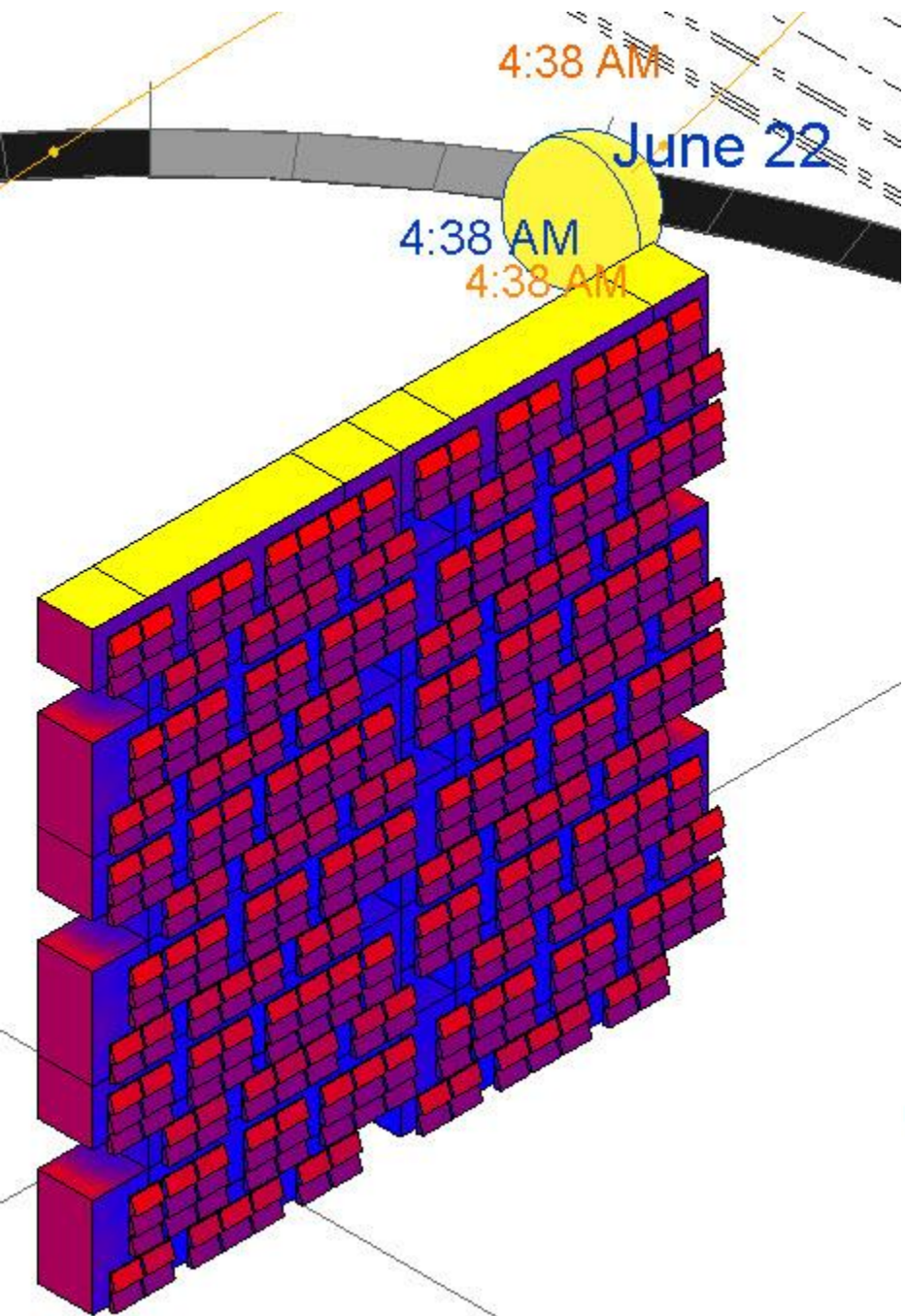

Project location: Ervin Way, California City, CA, USA  
Sun study start date time: 6/22/2010 4:38:00 AM  
Sun study end date time: 6/22/2010 7:07:00 PM



# Solar Study- Spring Equinox

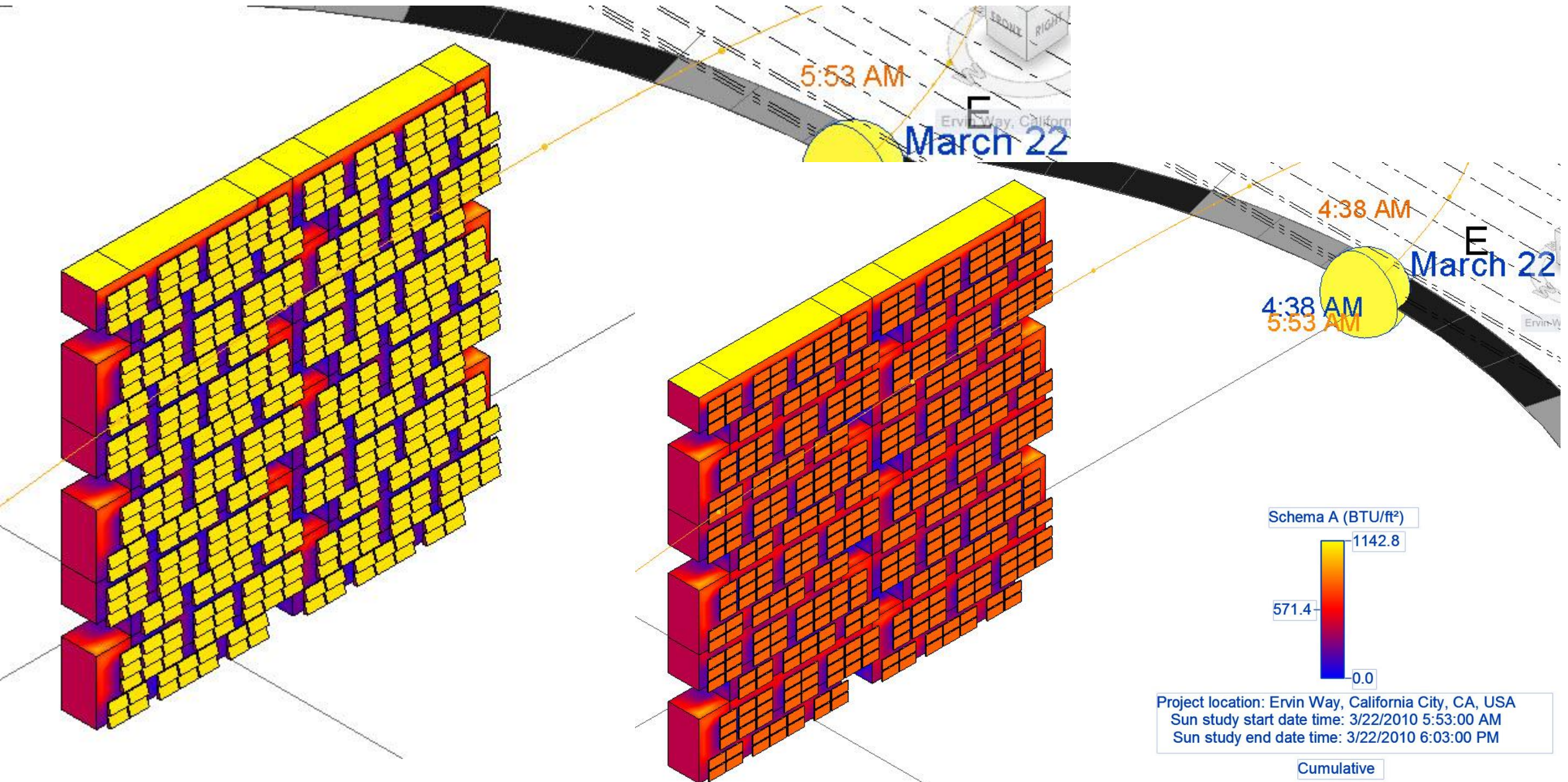



# Solar Study – Fall Equinox

