



Photo © 2010 Erin Crumpacker In Construction

HIGH LINE 23 BY NEIL M DENARI ARCHITECTS

Site Considerations and Zoning

Week One: Class 02

Lecture: Site:

- Site Considerations.
- Zoning Requirements
- Zoning and building massing
- Sustainability and building orientation

Lab [Computer Topics]:

- Site boundaries
- Zoning boundaries
- Setbacks and massing requirements

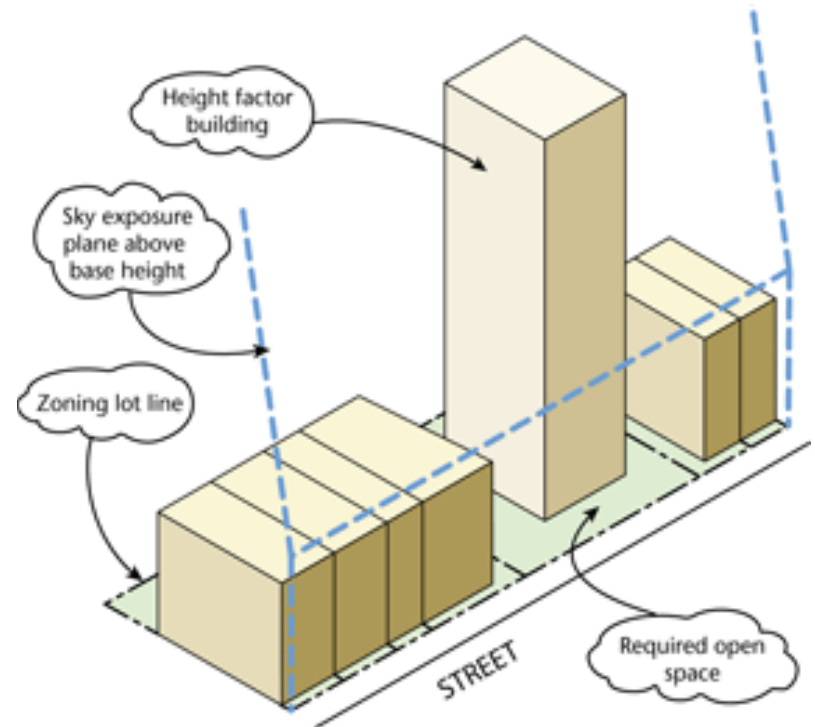

About Zoning

Zoning shapes the city. Compared with architecture and planning, zoning has a relatively short history as a means of organizing the way land is used. Yet zoning determines the size and use of buildings, where they are located and, in large measure, the density of the city's diverse neighborhoods. Along with the city's power to budget, tax, and condemn property, zoning is a key tool for carrying out planning policy. New York City has been a pioneer in the field of zoning since it enacted the nation's first comprehensive zoning ordinance in 1916.

Department of City Planning

<http://www.nyc.gov/html/dcp/html/zone/zonehis.shtml>

STRUCTURE OF THE ZONING RESOLUTION

Articles I - VII - Zoning Regulations.

- Article II - Residential Districts
use, bulk, off-street parking and loading;
Inclusionary Housing; urban design guidelines;
Quality Housing program. (§21-00 to 28-53)
- Article III - Commercial Districts
use, bulk, off-street parking and loading; urban
design guidelines. (§31-00 to 37-06)
- Article IV - Manufacturing Districts
use, bulk, off-street parking and loading.
(§41-00 to 44-585)



Articles VIII - XII - Special District Regulations

Residents Business Visitors Government Office of the Mayor Search Email Updates Contact Us

NYC
.gov
always open

NEW YORK CITY
DEPARTMENT OF CITY PLANNING

NYC.gov/planning Search DCP > Go

Department of City Planning - "Shaping the City's Future"

City Planning:

- Home
- About Us
- Zoning
- Land Use Process
- Projects/Proposals
- Reference
- Products
- News

Stay Connected:

- Twitter
- RSS Feed

Take me to...

- Commission Meetings
- Commission Reports
- LUCATS - Land Use Application Tracking
- ZoLa - Zoning and Land Use Application
- Community Data Portal
- DCP Rezonings
- Zoning Map Finder
- Map & Bookstore
- Job Opportunities
- Press Releases
- DCP Site Map
- Contact DCP

Community Data Portal

Borough

Your Neighborhood

GO >>

Zoning 

ZoLa - Zoning and Land Use Application

With the Department of City Planning's Zoning and Land Use (ZoLa) application you can find the zoning for a property, discover new proposals for your neighborhood and learn where City Planning initiatives apply across NYC.



Zoning Text

The zoning text consists of 13 articles. Articles I through VII contain the regulations that apply to every residential, commercial and manufacturing district. Articles VIII through XIII contain the regulations for the special purpose districts.



Zoning Maps

The 126 New York City zoning maps show the locations and boundaries of zoning districts, special purpose districts and commercial overlay districts. The zoning maps can be accessed by selecting from a list or picked out visually from an overview map.



Zoning Districts

Zoning Districts summarizes the regulations for each district, including illustrations of typical building forms. Special purpose districts, tailored to distinctive qualities in certain neighborhoods, are also presented. Full requirements for all zoning districts are found in the Zoning Resolution.



Zoning Tools

Zoning Tools summarizes specific land use initiatives that address particular policy goals. They range from zoning incentives, such as the [Inclusionary Housing Program](#) and the [FRESH Food Program](#), to urban design and open space standards for public plazas, streetscapes and waterfront access areas.



About Zoning

Zoning shapes the city. Zoning determines the size and use of buildings, where they are located and, in large measure, the densities of the city's diverse neighborhoods. Along with the city's power to budget, tax, and condemn property, zoning is a key tool for carrying out planning policy. New York City has been a pioneer in the field of zoning policy since it enacted the nation's first comprehensive Zoning Resolution in 1916.



Zoning Glossary

Zoning Information Desk

For general information about specific properties such as the zoning district and the type of uses allowed.

- By Phone:
(212) 720-3291
- In Person:
22 Reade St.
Third Floor
New York, NY 10007

Monday - Friday:
9am-12pm, 1pm-4pm

Zoning Handbook



Updated and expanded plain language guide to NYC zoning regulations.

[View excerpts.](#)

STRUCTURE OF THE ZONING RESOLUTION



Equitable Life Building 537ft tall (40 story)

- Zoning District
- Use Use Groups
Signs
- Bulk: Floor Area Ratio (FAR)
Maximum Lot Coverage
Yard Regulations
Height & Setback Regulations
Courts
- Parking and Loading
- Other

ZONING

ZONING MAPS

The screenshot displays the NYC ZOLA web application. At the top left is the NYC.gov logo. The top right contains navigation links: Search | Email Updates | Contact Us. Below this is a header for 'Residents | Business | Visitors | Government | Office of the Mayor'. The main interface features the 'ZOLA zoning & land use' logo and a navigation bar with links for 'DISCLAIMER', 'FEEDBACK FORM', and 'HELP'. The 'NYC PLANNING' logo is also present. A search bar is located at the top right of the map area. The map itself shows a grid of streets with various zoning districts labeled, including C6-2A, R7A, R8, C6-1, C6-2G, C6-2, and 4-4A. Specific landmarks like 'Allen Mall One', 'R7A Nathan Straus Playground', and 'Seward Park' are highlighted. A sidebar on the right contains a search bar and a list of data layers to be shown on the map, including Zoning, Other Zoning Designations, Environmental Requirements, Waterfront, Land Use, Other Program Areas, Landmark, and Administrative. The bottom left corner of the map area has a copyright notice: 'Copyright 2012 The City of New York'.

<http://gis.nyc.gov/doitt/nycitymap/template?applicationName=ZOLA>

ZONING MAPS

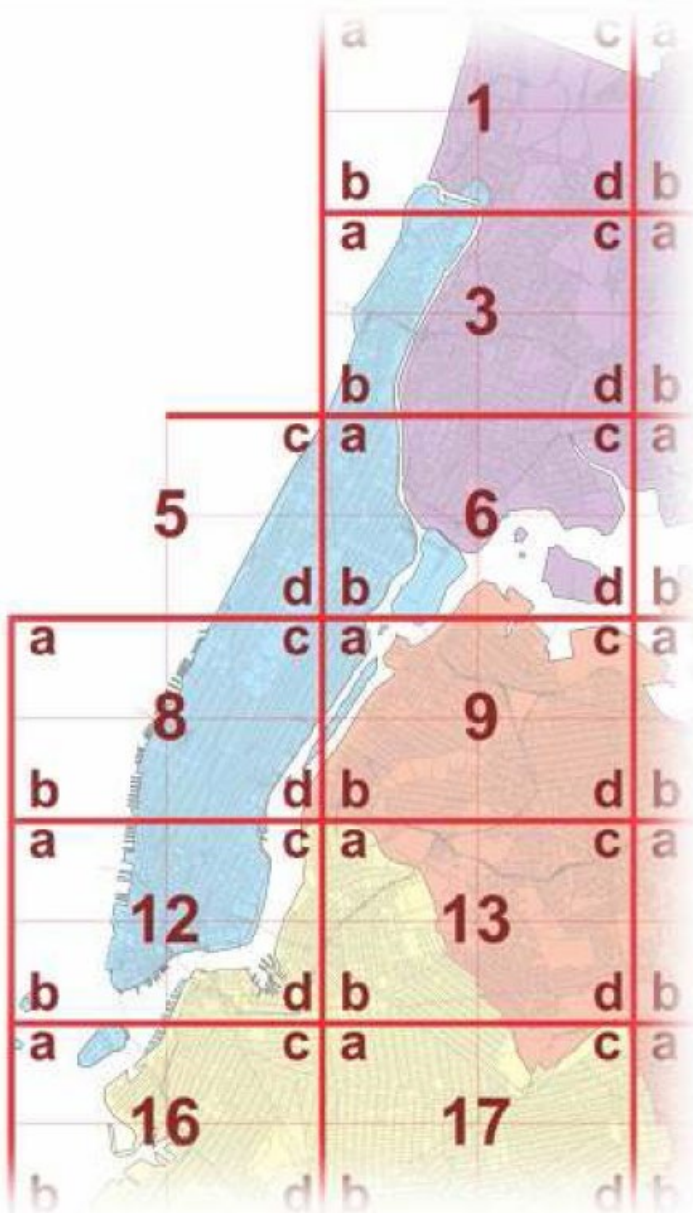

The 126 City Planning base maps are made up of 35 sections, each identified by a number from 1 to 35.

Zoning maps are further divided into four quarters, each identified by letter: a, b, c or d.

Each zoning section map covers approximately 8,000 feet (N-S) by 12,500 feet (E-W)

ZONING MAPS



- Each zoning district is designated by a letter indicating the general use classification -- **R** for Residence, **C** for Commercial and **M** for Manufacturing -- followed by a number.

- Heavy solid lines indicate the boundaries of zoning districts. Certain districts (such as Special Districts or C1 or C2 districts) are mapped as overlays, modifying-but not totally supplanting-the controls of the underlying district.

- Article VII, Chapter 6 (§76-00 through 76-148) establishes the location of district boundaries.

ZONING

ZONING DISTRICTS

In **R** districts, the first number indicates permitted bulk and parking.

Most **C** districts have two numbers in their designation:

- the first number indicates permitted uses
- the second number indicates permitted bulk, required parking or both

All **M** districts have two numbers in their designation:

- the first number indicates permitted uses
- the second number, after a hyphen, indicates permitted bulk, required parking or both

SPECIAL PURPOSE DISTRICTS

Have superimposed on underlying districts.



USE GROUPS

The uses listed in each use group have common functional or nuisance characteristics.

Use Groups 1 - 2	residential
Use Groups 3 - 4	community facilities
Use Groups 5 - 9	local retail and services
Use Groups 10 - 12	regional shopping centers/amusement
Use Groups 13 - 15	waterfront/recreation uses
Use Group 16	heavy automotive service
Use Groups 17 - 18	manufacturing

The text identifies which use groups are permitted in each zoning district.

Index of Uses in Appendix A of the Zoning Resolution

BULK

The maximum size (or bulk) of a building on a lot is determined by the floor area ratio (FAR) assigned to each zoning district.

DETERMINE AREA OF ZONING LOT

- The FAR expresses the relationship between the amount of usable floor area permitted in a building and the area of the lot on which the building stands.

CALCULATE PERMITTED FLOOR AREA

- A building can contain FAR to the lot area multiplied by FAR of the district in which the lot is located.

BONUSES

- In certain districts, the basic FAR permitted on a lot can be increased if certain public amenities are provided



BULK

Floor Area Ratio (FAR)

For example, on a 10,000 square foot zoning lot in a district with a maximum FAR of 1.0, the floor area on the zoning lot cannot exceed 10,000 square feet.

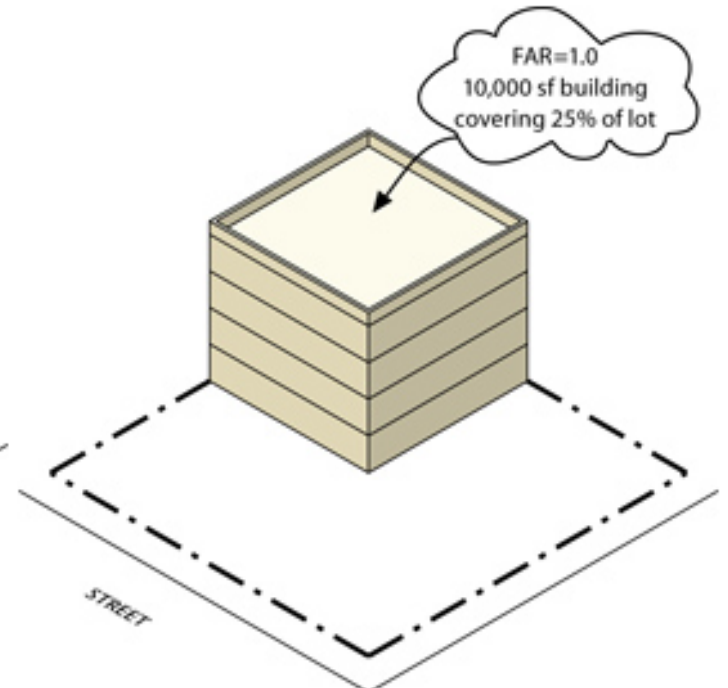
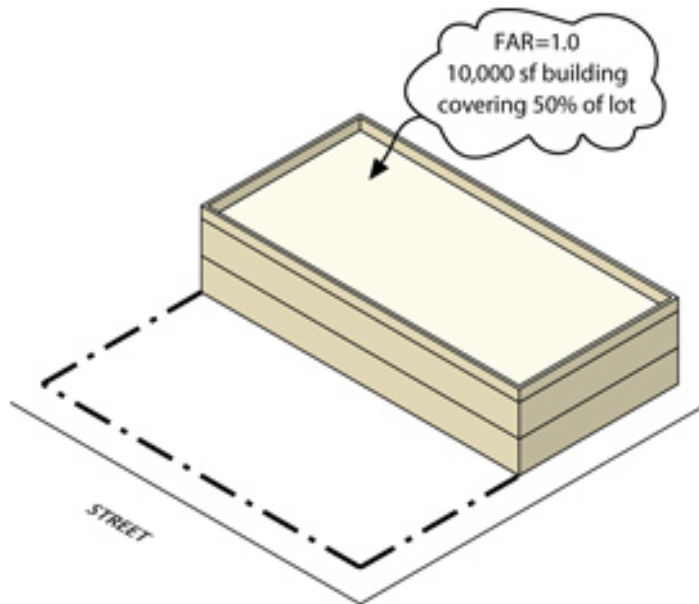
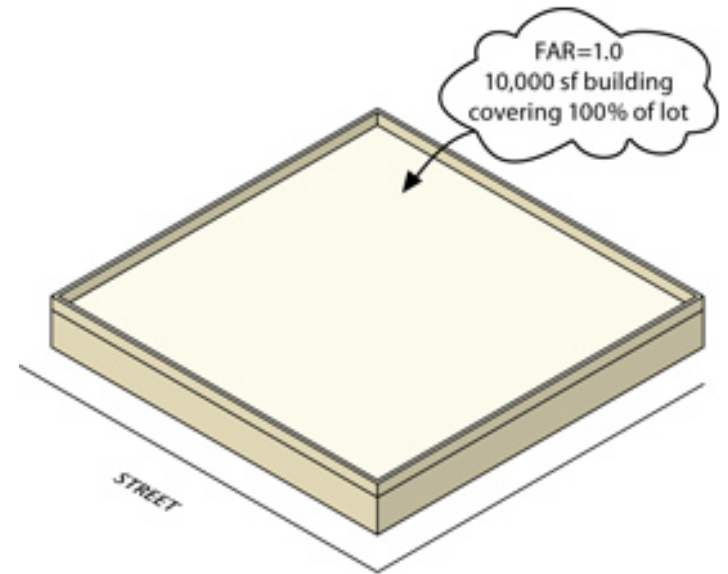

BULK

OPEN SPACE RATIO

- In certain residence districts, residential development must provide open space on the zoning lot (§27-14).
- In some districts, the amount of open space required is determined by the open space ratio (OSR) which expresses the percentage of total floor area of a building that must be provided as open space on a development parcel.
- In other residence districts, open space is determined by yard regulations or by limiting development to a maximum lot coverage.



BULK



MAXIMUM LOT COVERAGE

- Lot coverage is that portion of a zoning lot covered by a building or any part of a building.
- Maximum allowable lot coverage is determined by a combination of yard requirements and any urban design regulations that may be Applicable.

Quality Housing Program is a set of zoning regulations in R6 - R10 Districts and their commercial equivalents

BULK

YARDS (COMMERCIAL DISTRICTS)

Front yards are not required in C Districts (§33-24).

- Some Special Districts require sidewalk widenings which in effect locates the street wall at a specified distance from the lot line.

Side yards are not required in C Districts. (§33-25)

- If a side yard is provided, certain dimensional requirements must be met.

Rear yard of minimum 20' depth is required in all C Districts. (§33-26)

- Corner lots are exempted from rear yard requirements
- Shallow lots are permitted reductions in rear yard minimums (§33-27).
- Through lots must provide rear yard equivalents in some C Districts (§33-28)

Permitted obstructions are listed in §33-23

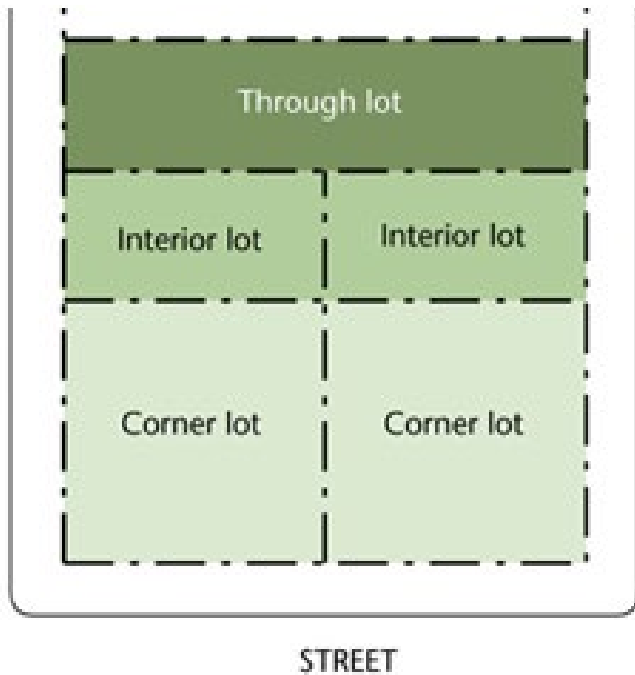

STREET

STREET

BULK

HEIGHT AND SETBACK

In most medium and higher density districts:

- A building's front wall at the street line is generally limited to a specified height or number of stories -- street wall height -- above which the building face must setback a specified distance.
- Above the street wall height, a building is required to set back behind a theoretical inclined plane -- the sky exposure plane -- which cannot be penetrated by the building.

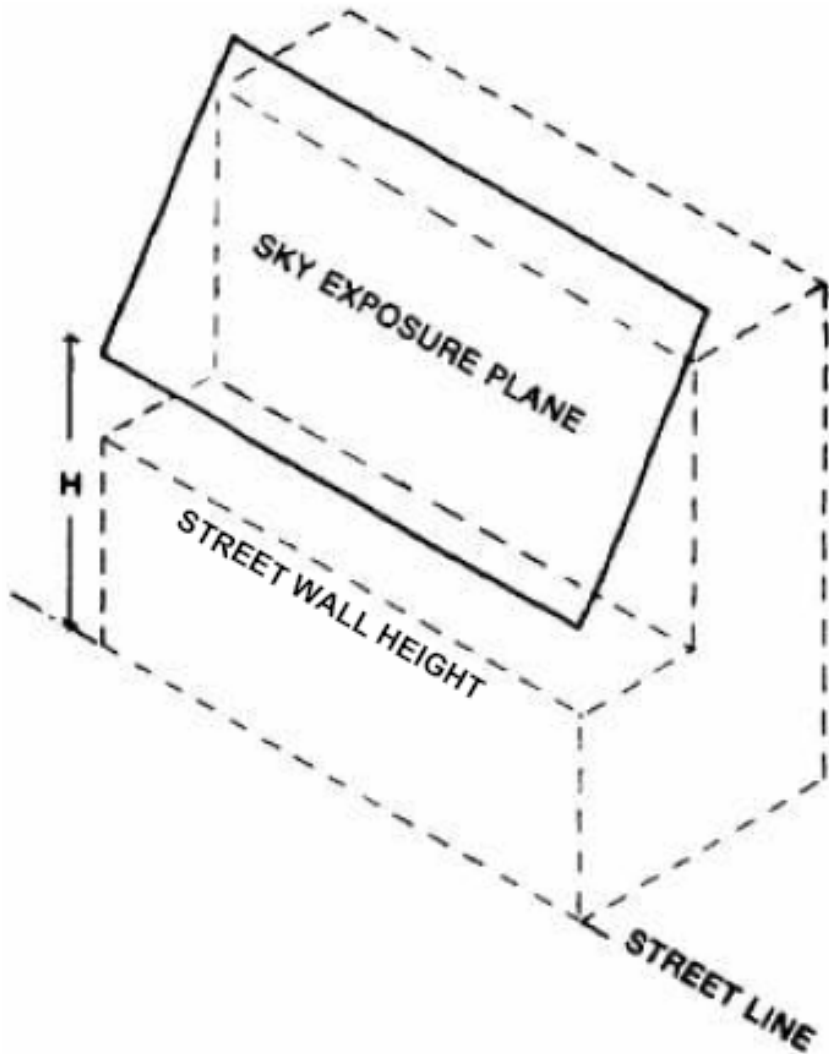

BULK

HEIGHT AND SETBACK

In most medium and higher density districts:

- A rear sky exposure plane is required in some districts to provide greater light and air.

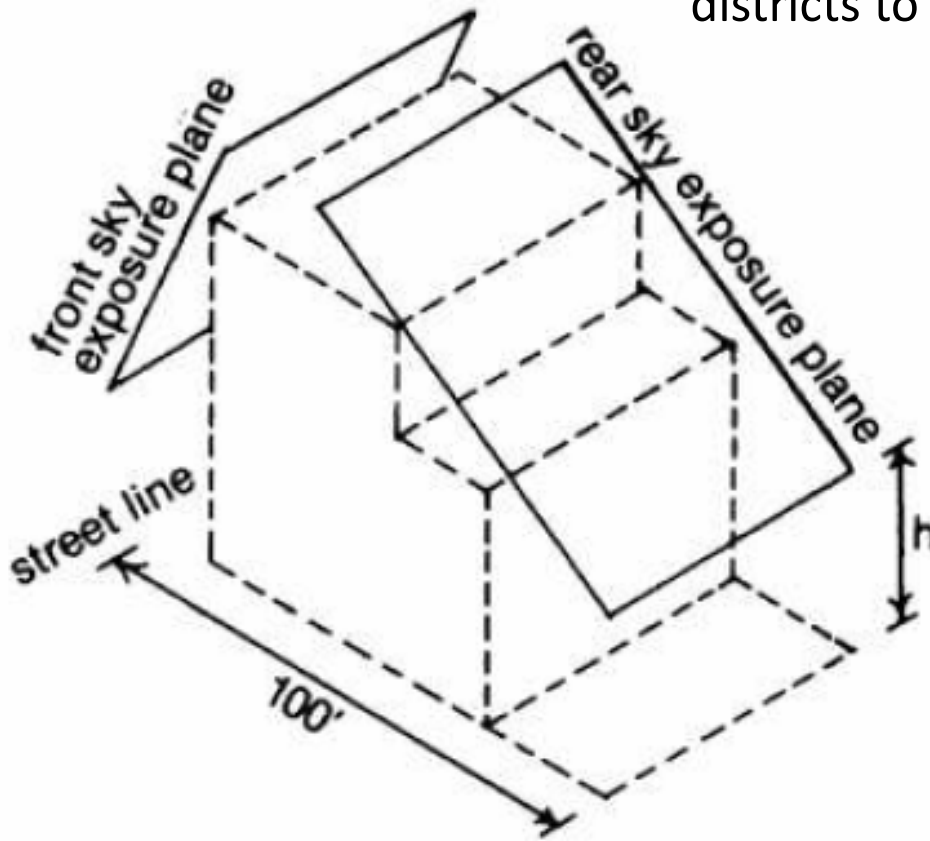

- Exception: a tower rising without setback which covers only 40% of its lot is permitted to penetrate the sky exposure plane because its compensating slender profile provides more open space at the street level.

PARKING

- Most new developments require off-street parking.
- Curb cut sizes and locations are regulated
- Off-street loading berths for commercial and manufacturing uses may be required.
- Developments of small sizes may be exempt from parking requirements
- Parking is required for most commercial and community facility uses in all commercial districts except those located in Lower/Mid-Manhattan and Downtown Brooklyn.



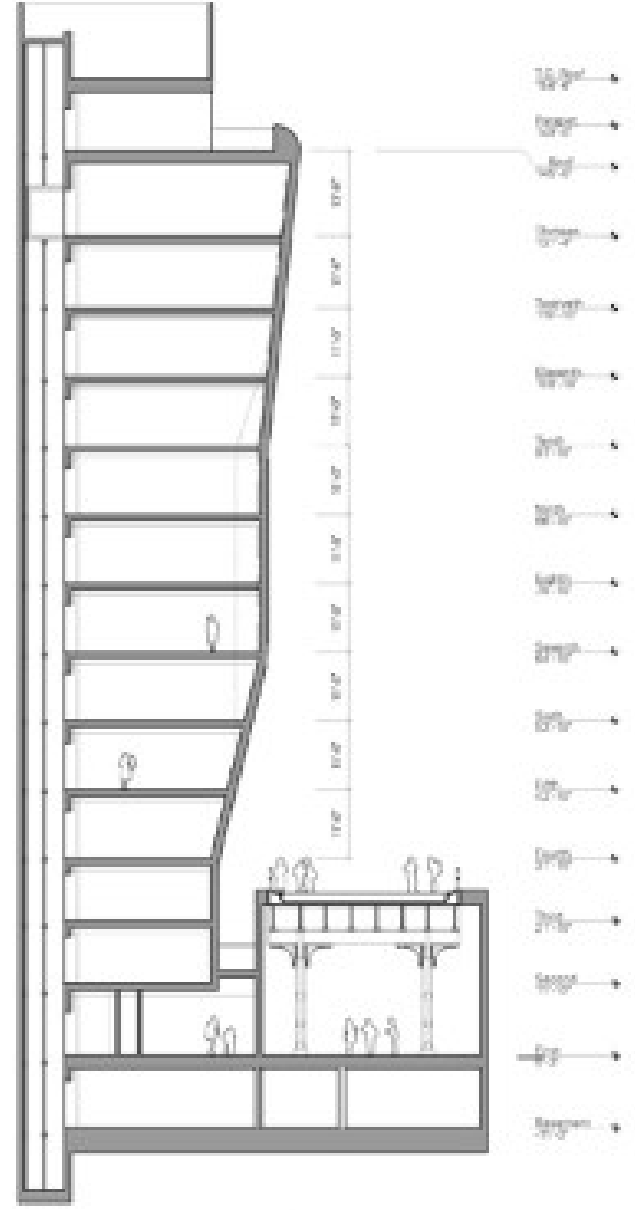

HIGH LINE 23 BY NEIL M DENARI ARCHITECTS

Sustainability and building orientation

1. Porous concrete to maximize site stormwater infiltration
2. Optimized building orientation for active and passive solar capture
3. 143 kW photovoltaic panel array
4. Solar thermal collectors (22 kW energy contribution)
5. Masonry shear cores provide daylighting, high thermal mass and stack-aided natural cooling (fan assist)
6. Structural insulated panel system
7. Modular structural steel frame to enhance building flexibility for changing user needs
8. Operable windows provide natural cooling and daylight harvesting
9. High recycled content, low VOC and regionally produced materials
10. High efficiency L.E.D. and fluorescent interior and exterior lighting
11. High fly ash content structural concrete
12. Reclamation of former Naval dumping facility site
13. Radiant in-floor heating and free cooling
14. Social gathering nodes encourage interaction and creative exchange of ideas
15. Geothermal heat exchangers
16. Exposed building systems to enhance user awareness and connection to resource use
17. FSC certified regional wood products
18. Bioretention area collects excess roof stormwater to achieve 65/10/0 low impact site stormwater strategy
19. Site stormwater collection and re-use
20. Heat recovery ventilation

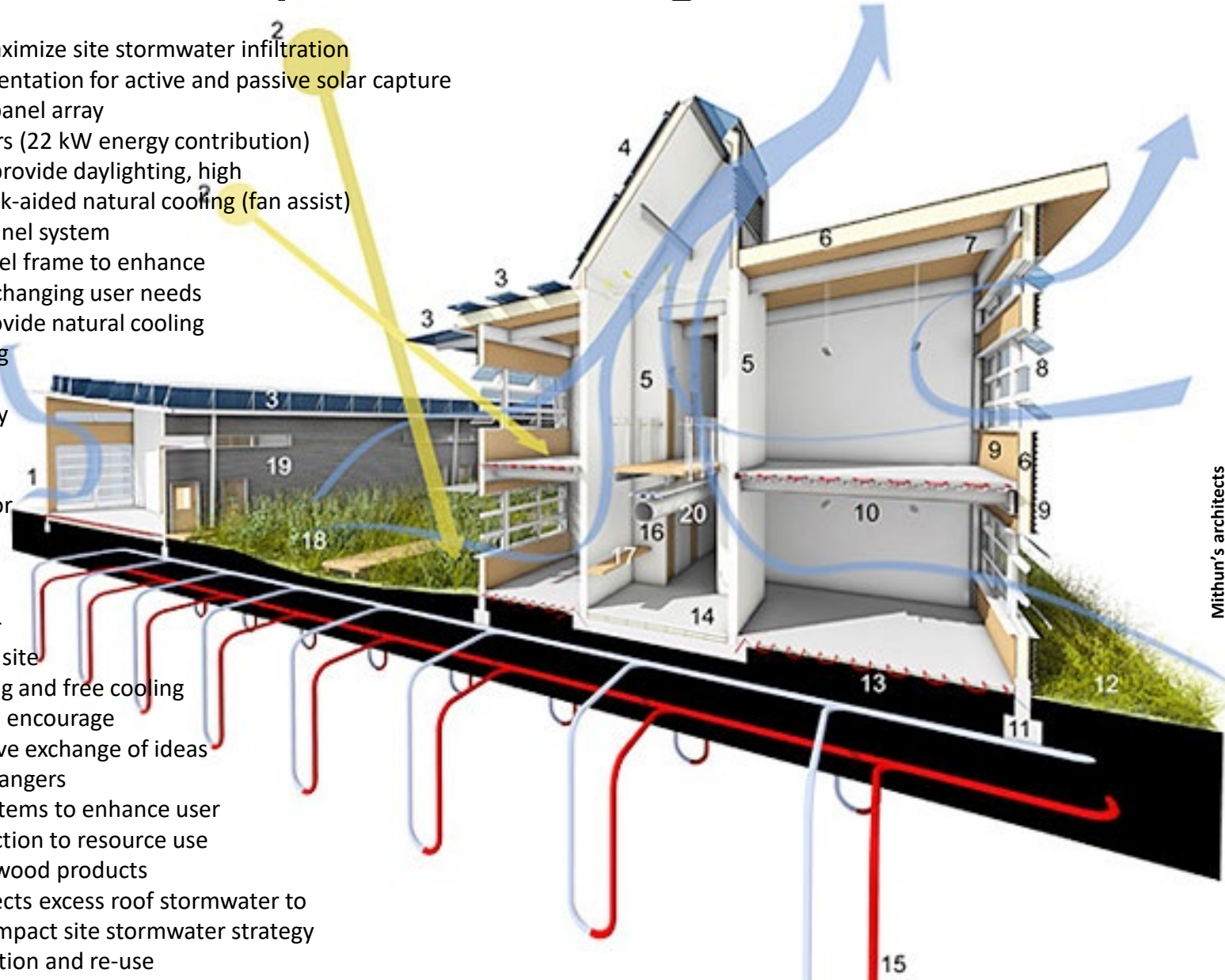

Course project and development process

Location: 285 Jay Street, Brooklyn
(between Tillary Street and Tech Place)

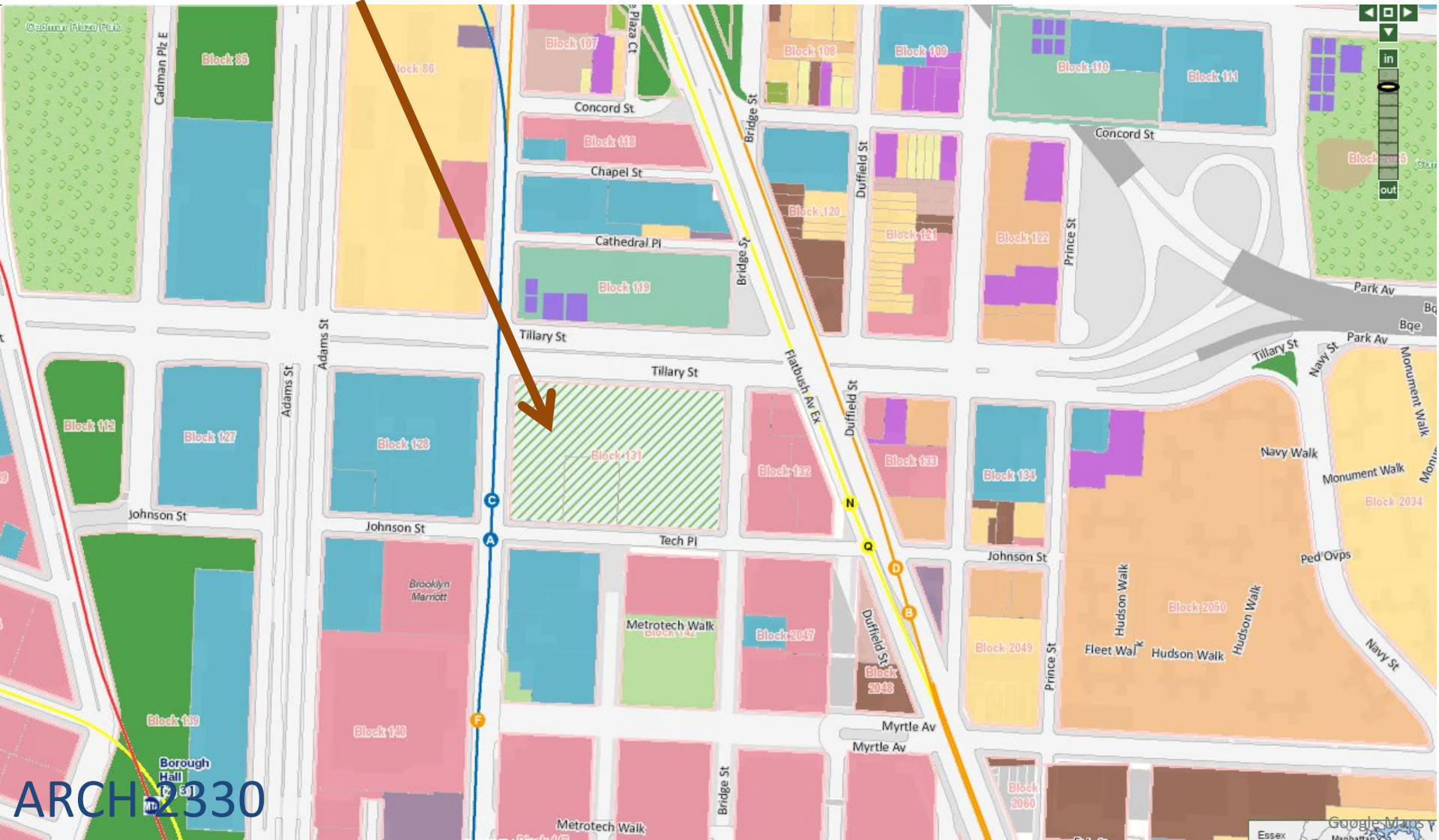



ARCH 2330

Site boundaries

Tax lots private a good source of site boundaries.

You can use the OASISNYC.net website for access to maps and contextual information.

The screenshot displays the OASISNYC.net website interface. At the top, there is a search bar with tabs for 'Address', 'Block & Lot', 'ZIP Code', 'Neighborhood', 'Community District', and 'County/Borough'. Below the search bar is a map of New York City with various layers and search options. A large black arrow points to the search bar, and a text box overlaid on the map says 'Locate your site by zooming or by using the address.' The map shows various geographical features and land use categories. On the right side, there is a legend and a list of layers to be displayed, including 'Transit, Roads, Reference Features', 'Parks, Playgrounds, & Open Space', 'Environmental Stewardship Groups', 'Environmental Characteristics', 'Environmental Impact/Cleanup', 'Zoning & Landmarks', 'Food Systems', and 'Land Use'. The 'Land Use' section is expanded, showing 'All land use categories' selected, with a timeline from 2003 to 2010. Below the timeline, there are color-coded categories for '1 & 2 Family Residential', 'Multi-family Residential', 'Mixed Use', and 'Open space & outdoor recreation'. At the bottom right, there is a 'Transparency Control' button.

<http://www.oasisnyc.net>

Site boundaries

1) Find and select the lots used in the project to access more information on them.

2) Location report

Activate the location report tab

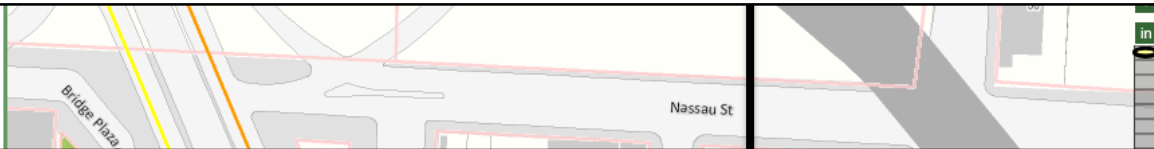

3) NYC Digital Tax Map

You can use this map to get your site dimensions.

For the this project assume all angles are right angles.

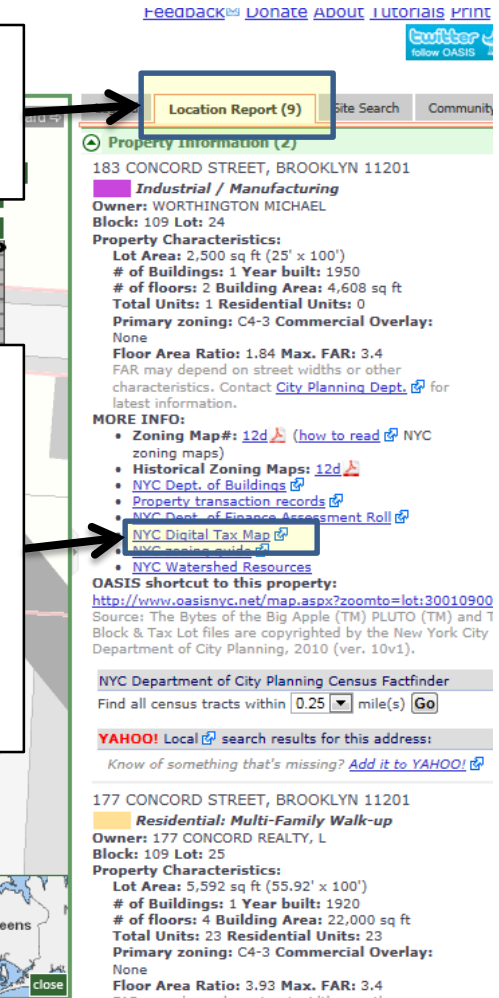
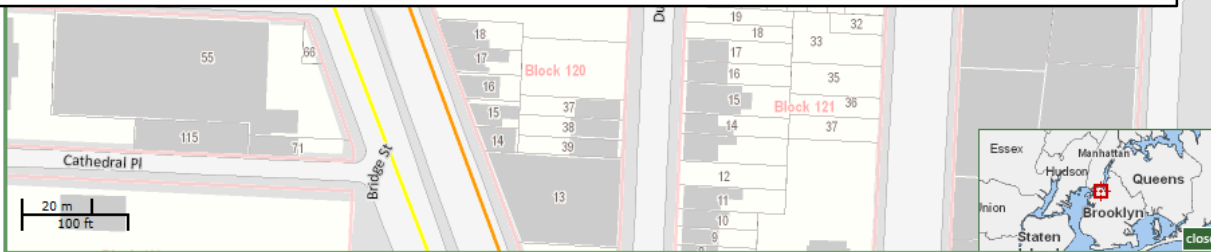

[Feedback](#) [Donate](#) [About](#) [Tutorials](#) [Print](#)

[Location Report \(9\)](#) Site Search Community

Property Information (2)
183 CONCORD STREET, BROOKLYN 11201
Industrial / Manufacturing
Owner: WORTHINGTON MICHAEL
Block: 109 Lot: 24

Property Characteristics:
Lot Area: 2,500 sq ft (25' x 100')
of Buildings: 1 Year built: 1950
of floors: 2 Building Area: 4,608 sq ft
Total Units: 1 Residential Units: 0
Primary zoning: C4-3 Commercial Overlay: None
Floor Area Ratio: 1.84 Max. FAR: 3.4
FAR may depend on street widths or other characteristics. Contact [City Planning Dept.](#) for latest information.

MORE INFO:

- [Zoning Map#:](#) [12d](#) (how to read NYC zoning maps)
- [Historical Zoning Maps:](#) [12d](#)
- [NYC Dept. of Buildings](#)
- [Property transaction records](#)
- [NYC Dept. of Finance Assessment Roll](#)
- [NYC Digital Tax Map](#)
- [NYC Watershed Resources](#)

OASIS shortcut to this property:
<http://www.oasisnyc.net/map.aspx?zoomto=lot:30010900>
Sources: The Bytes of the Big Apple (TM) PLUTO (TM) and T Block & Tax Lot files are copyrighted by the New York City Department of City Planning, 2010 (ver. 10v1).

NYC Department of City Planning Census Factfinder
Find all census tracts within mile(s)

YAHOO! Local search results for this address:
Know of something that's missing? [Add it to YAHOO!](#)

177 CONCORD STREET, BROOKLYN 11201
Residential / Multi-Family Walk-up
Owner: 177 CONCORD REALTY, L
Block: 109 Lot: 25

Property Characteristics:
Lot Area: 5,592 sq ft (55.92' x 100')
of Buildings: 1 Year built: 1920
of floors: 4 Building Area: 22,000 sq ft
Total Units: 23 Residential Units: 23
Primary zoning: C4-3 Commercial Overlay: None
Floor Area Ratio: 3.93 Max. FAR: 3.4

<http://www.oasisnyc.net>

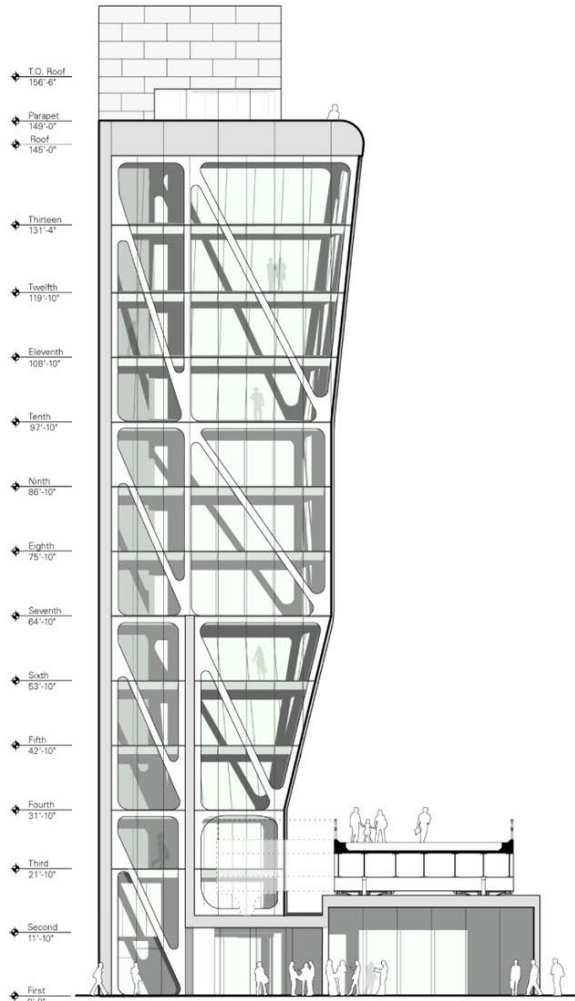

South Elevation

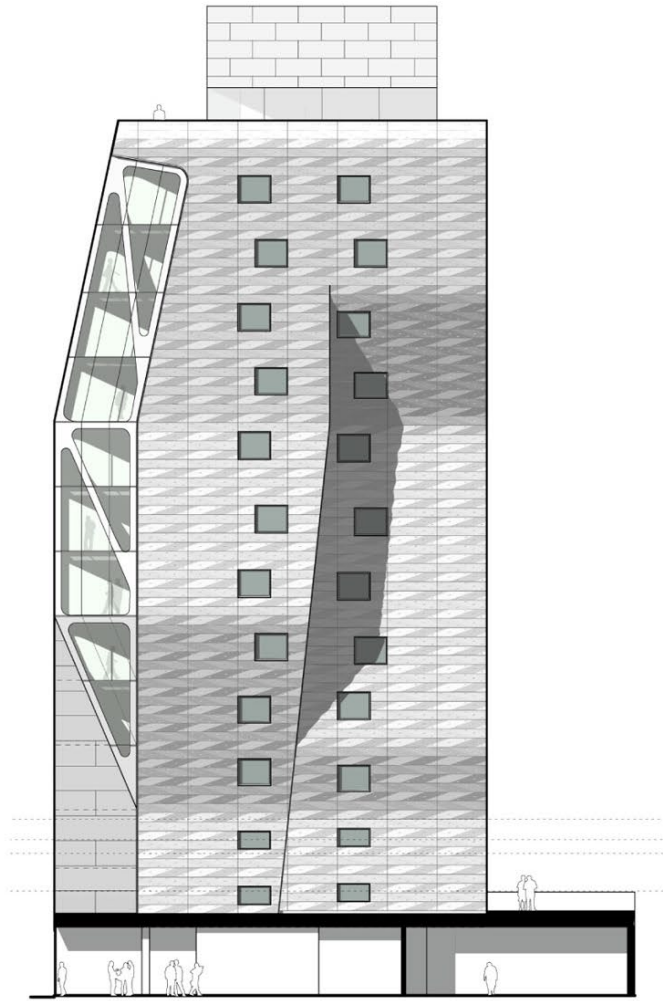

East Elevation

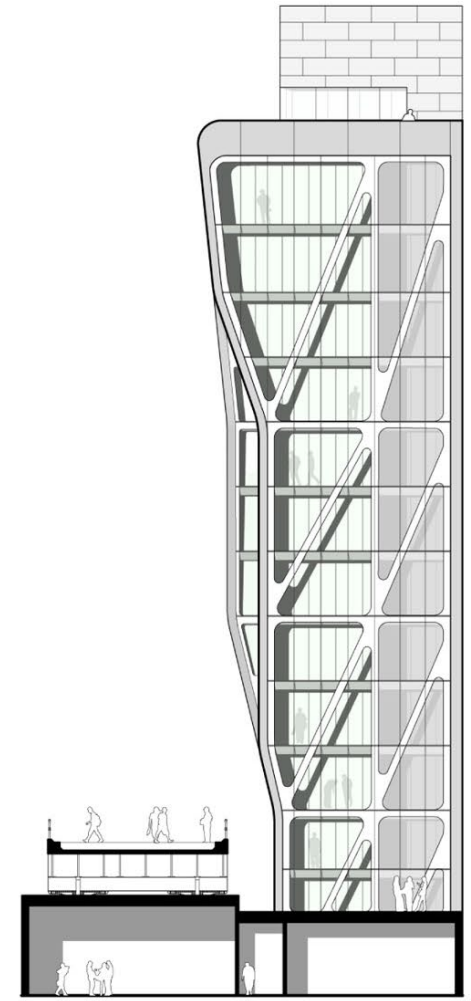

North Elevation

Images; <http://www.archdaily.com> from, Neil Denari Architects

HIGH LINE 23 BY NEIL M DENARI ARCHITECTS

Zoning Analysis Assignment

Project Description:

Students will divide into teams groups of 3 to 4 persons to study their site. The teams will research the means and bounds and a zoning requirements of their site. Upon completing the research team will conduct a zoning analysis of the site.

In your zoning calculation numerous indicate what the site's FAR, zoning envelope, street wall height, setbacks, and sky exposure plane are. Your research and calculations need to be documented for future use.

Using your calculations and research develop each student well draft a site plan in Revit. Post a JPEG or if you're site plan to blackboard.

Zoning Analysis Assignment

Process:

1. division into teams
2. acquire the site dimensions by using “<http://www.oasisnyc.net>”
3. research site zoning using “<http://www.nyc.gov/html/dcp/html/subcats/zoning.shtml>”
4. conduct and document your zoning analysis be sure to include the following values;
 - a. Zoning District
 - b. Use Group
 - c. FAR (Floor Area Ratio)
 - d. zoning envelope
 - e. street wall height
 - f. setbacks
 - g. sky exposure planes
5. Produce Zoning sheet including site plan (1:20 or 1:30), Isometric Zoning Diagrams, sections and notes.
6. Keep all relevant sections of the zoning code in your teams’ project binder.
7. Post completed sheet as a pdf and as a drawing file by the assigned deadline
8. add description to your post

Zoning Analysis

Your client is a University and they are requesting a building with a footprint of extending out to the property lines.

We will divide into student teams of 3 to 4 persons to develop a zoning analysis your site.

Keep your zoning calculations you will need them for your project documentation.

You will also use your results to your site plans.

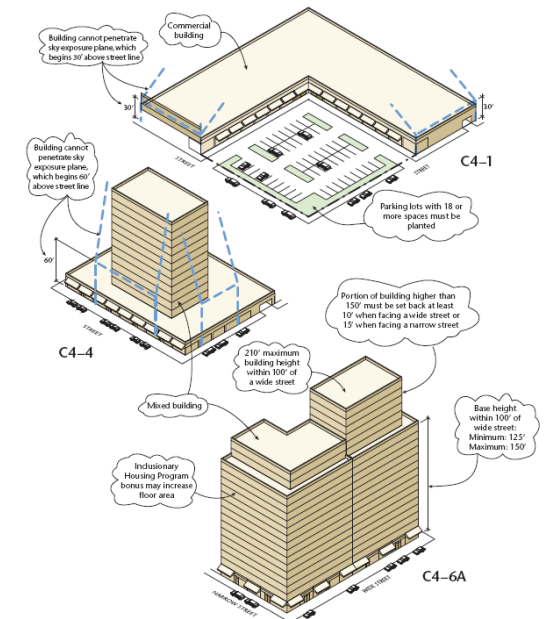
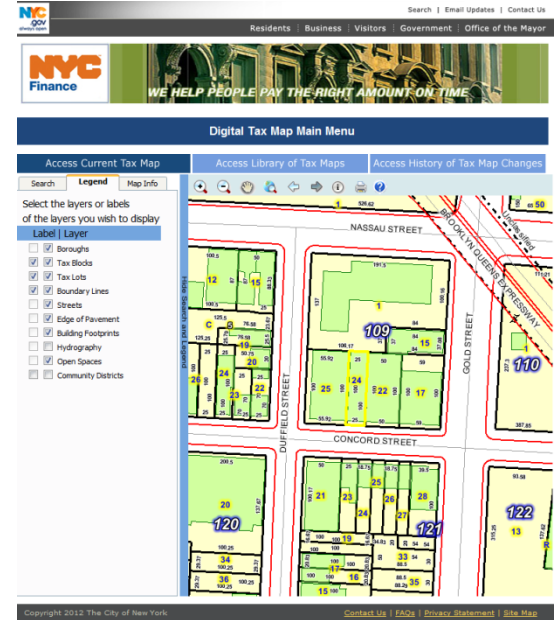



HIGH LINE 23 BY NEIL M DENARI ARCHITECTS

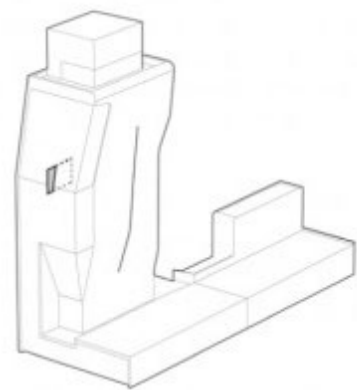
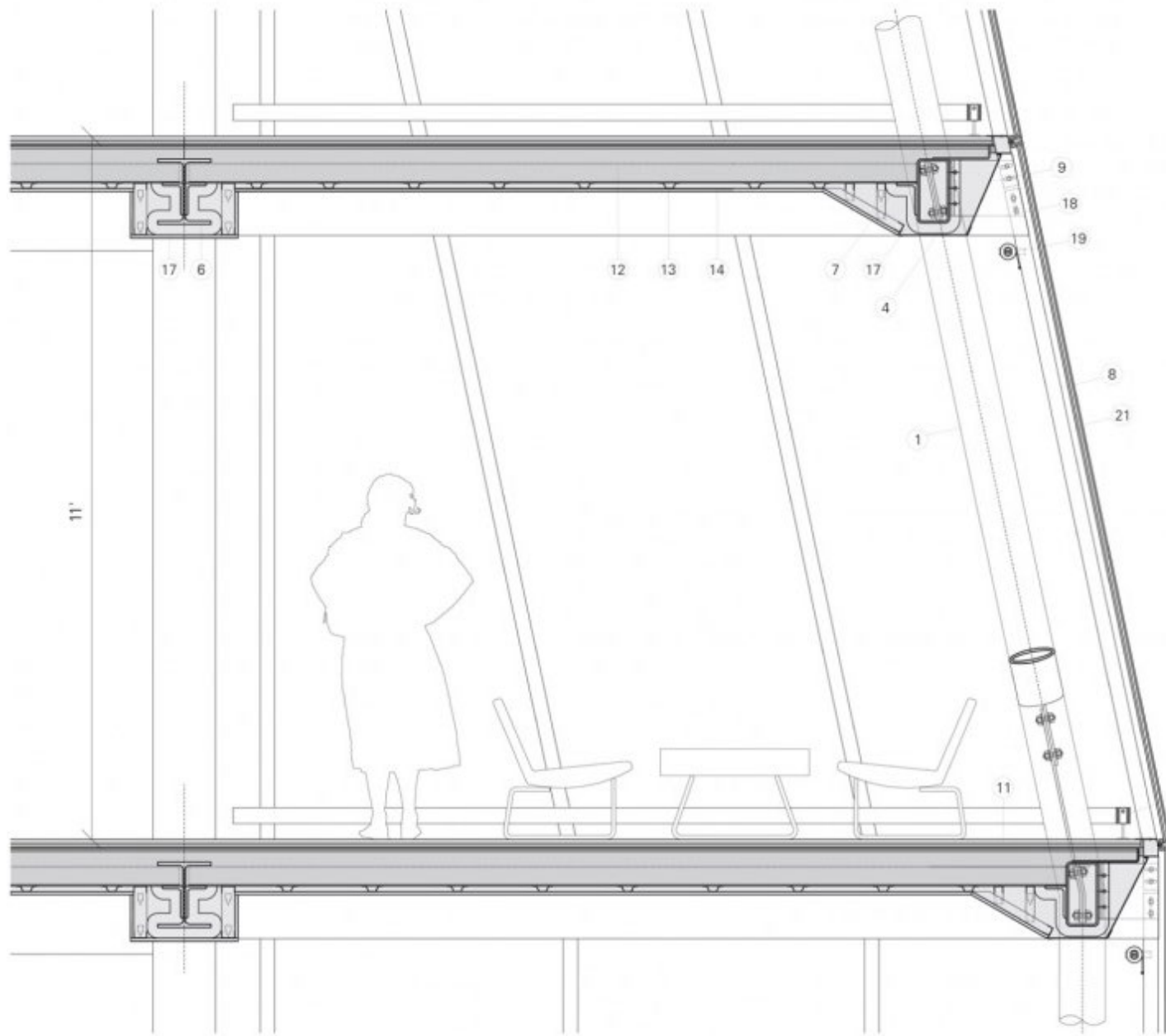

- 1 Column 8"Ø
- 2 Column W8x31
- 3 Column W8x35
- 4 Perimeter Beam 12x6x3/8"
- 5 Beam W10x22
- 6 Beam W12x58
- 7 Angle 6x4x1/2"
- 8 Solid Steel Mullion
- 9 Bracket
- 10 Perimeter Heating
- 11 Deck, Wood
- 12 Composite Cellular Deck
- 13 Hat Channel
- 14 GWB 5/8"
- 15 Exterior Grade Insulation
- 16 Moisture Barrier
- 17 Fire Proofing
- 18 Coping, Stainless Steel
- 19 Mechoshade
- 20 Metal Stud
- 21 Glass
- 22 Metal Panel
- 23 Panel
- 24 Denseglass
- 25 Pull-Out Window

HIGH LINE 23 BY NEIL M DENARI ARCHITECTS

Section detail

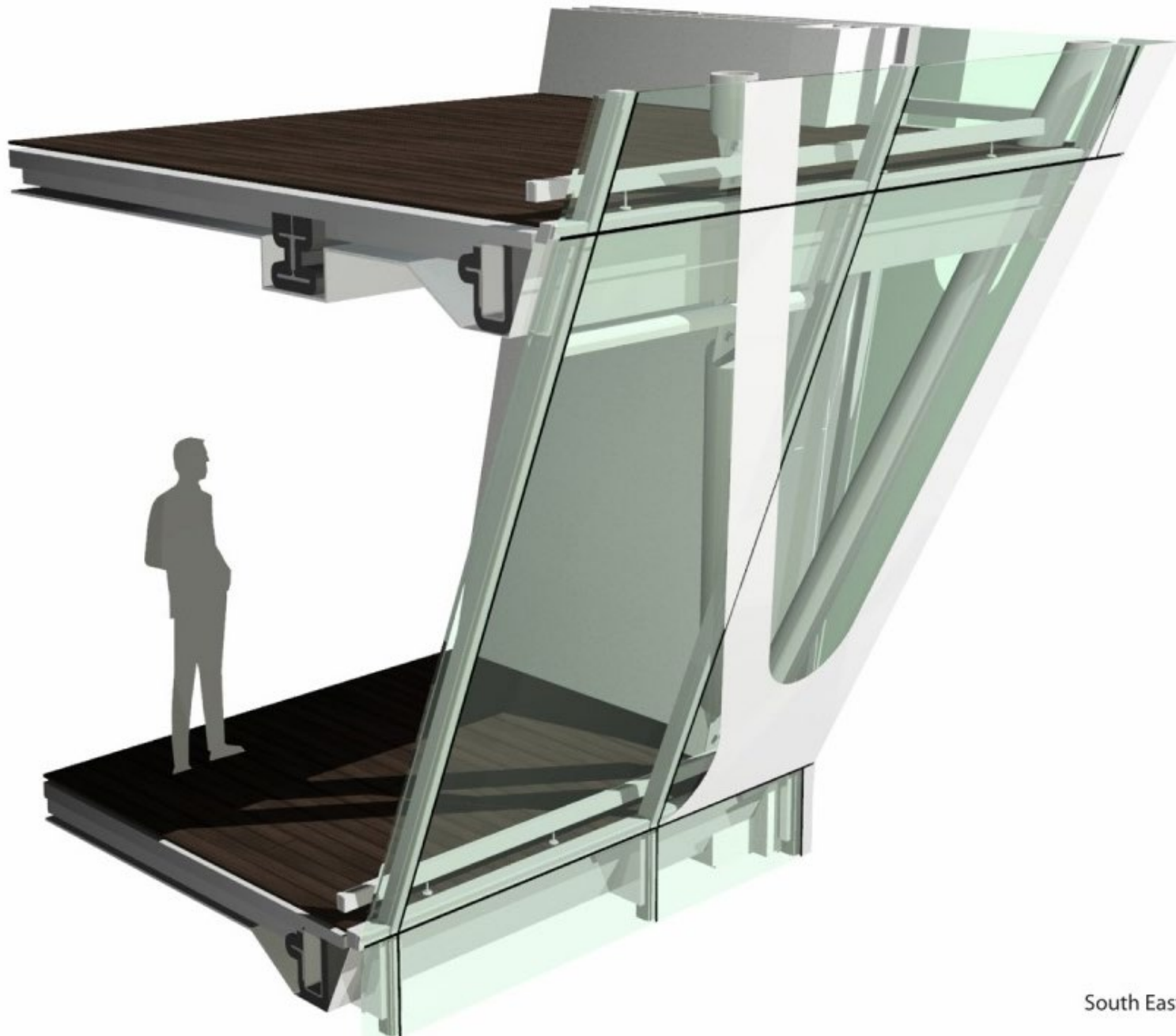

South East corner view

HIGH LINE 23 BY NEIL M DENARI ARCHITECTS